

**SUN2000 (8KTL-28KTL)**

# **User Manual**

**Issue**      10  
**Date**        2017-07-30

**Copyright © Huawei Technologies Co., Ltd. 2017. All rights reserved.**

No part of this document may be reproduced or transmitted in any form or by any means without prior written consent of Huawei Technologies Co., Ltd.

## **Trademarks and Permissions**



and other Huawei trademarks are trademarks of Huawei Technologies Co., Ltd.

All other trademarks and trade names mentioned in this document are the property of their respective holders.

## **Notice**

The purchased products, services and features are stipulated by the contract made between Huawei and the customer. All or part of the products, services and features described in this document may not be within the purchase scope or the usage scope. Unless otherwise specified in the contract, all statements, information, and recommendations in this document are provided "AS IS" without warranties, guarantees or representations of any kind, either express or implied.

The information in this document is subject to change without notice. Every effort has been made in the preparation of this document to ensure accuracy of the contents, but all statements, information, and recommendations in this document do not constitute a warranty of any kind, express or implied.

## **Huawei Technologies Co., Ltd.**

Address: Huawei Industrial Base  
Bantian, Longgang  
Shenzhen 518129  
People's Republic of China

Website: <http://www.huawei.com>

Email: [support@huawei.com](mailto:support@huawei.com)

# About This Document

## Purpose

This document describes the SUN2000 inverter in terms of its installation, electrical connections, commissioning, maintenance, and troubleshooting. Readers should be familiar with the SUN2000 features and functions and safety precautions provided in this document before installing and operating the SUN2000.

Store the physical documentation shipped with the product properly for future reference.





This document is subject to update and revision. The latest version can be downloaded from <http://support.huawei.com>.


## Intended Audience

This document is intended for photovoltaic (PV) plant operators and qualified electrical technical personnel.

## Symbol Conventions

The symbols that may be found in this document are defined as follows.

Symbol	Description
 <b>DANGER</b>	Indicates an imminently hazardous situation which, if not avoided, will result in death or serious injury.
 <b>WARNING</b>	Indicates a potentially hazardous situation which, if not avoided, could result in death or serious injury.
 <b>CAUTION</b>	Indicates a potentially hazardous situation which, if not avoided, may result in minor or moderate injury.
 <b>NOTICE</b>	Indicates a potentially hazardous situation which, if not avoided, could result in equipment damage, data loss, performance deterioration, or unanticipated results. NOTICE is used to address practices not related to personal injury.

Symbol	Description
 NOTE	<p>Calls attention to important information, best practices and tips.</p> <p>NOTE is used to address information not related to personal injury, equipment damage, and environment deterioration.</p>

## Change History

Changes between document issues are cumulative. The latest document issue contains all the changes made in earlier issues.

### Issue 10 (2017-07-30)

Updated certain content of [5.4.1 Communications Ports](#).

Updated [10 Technical Specifications](#).

### Issue 09 (2017-02-21)

Updated certain content of [4.3 Determining the Installation Position](#).

Updated certain content of [8.2 Routine Maintenance](#).

### Issue 08 (2015-12-08)

Deleted descriptions about the SUN2000-24.5KTL.

Updated descriptions in [5.2 Connecting AC Output Power Cables](#).

Updated descriptions in [7.2.1 Viewing System Operating Information](#).

Added the **On-grid recovery time** parameter to [7.2.9 Setting Protection Parameters](#).

Added parameters **RCD enhancing** and **K-factor** to [7.2.10 Setting Feature Parameters](#).

Added [7.2.16 Resetting Alarms](#).

Added [7.2.17 Resetting the System](#).

Updated [B Power Grid Codes](#).

### Issue 07 (2014-07-30)

Added [4.4 Support-mounting the SUN2000](#).

Supplemented AC power cable specifications and models.

Modified the start time of the warranty period.

### Issue 06 (2014-06-05)

Added descriptions about the SUN2000-24.5KTL.

Added more precautions for **Installation** and **Maintenance and Replacement** in [1 Safety Precautions](#).

Added [3 SUN2000 Storage](#).

Added more maintenance items to [8.2 Routine Maintenance](#).

Added [B Power Grid Codes](#).

### **Issue 05 (2014-03-25)**

Added cable types and precautions for cable connections in [5.3 Connecting DC Input Power Cables](#).

Modified the output power of the inverter at different temperatures in **General Data** in [10 Technical Specifications](#).

### **Issue 04 (2013-11-25)**

Added description about the SUN2000-23KTL.

### **Issue 03 (2013-10-11)**

Added descriptions about the SUN2000-28KTL.

### **Issue 02 (2013-06-08)**

This issue is the second official release.

### **Issue 01 (2013-04-26)**

This issue is the first official release.

---

# Contents

---

<b>About This Document</b> .....	<b>ii</b>
<b>1 Safety Precautions</b> .....	<b>1</b>
<b>2 Overview</b> .....	<b>4</b>
2.1 Introduction .....	4
2.2 Appearance .....	6
2.3 Label Conventions .....	8
2.4 Monitoring Panel .....	10
2.5 Working Principles.....	13
<b>3 SUN2000 Storage</b> .....	<b>17</b>
<b>4 Installation</b> .....	<b>18</b>
4.1 Checking Before Installation .....	18
4.2 Tools .....	20
4.3 Determining the Installation Position .....	23
4.4 Support-mounting the SUN2000 .....	27
4.5 Wall-mounting the SUN2000.....	32
<b>5 Electrical Connections</b> .....	<b>41</b>
5.1 Connecting PGND Cables .....	41
5.2 Connecting AC Output Power Cables.....	44
5.3 Connecting DC Input Power Cables .....	51
5.4 Connecting Communications Cables .....	57
5.4.1 Communications Ports.....	57
5.4.2 Connecting RS485 Communications Cables .....	59
<b>6 System Operation</b> .....	<b>64</b>
6.1 Checking Before Power-On.....	64
6.2 Powering On the SUN2000 .....	64
6.3 Setting Initialization Parameters .....	65
<b>7 Man-Machine Interaction</b> .....	<b>68</b>
7.1 Monitoring Menu Hierarchy .....	68
7.2 Monitoring Operations.....	71
7.2.1 Viewing System Operating Information .....	71

---

7.2.2 Viewing Alarm Records .....	76
7.2.3 Setting System Time .....	79
7.2.4 Setting the System Language .....	81
7.2.5 Setting the Contrast .....	83
7.2.6 Setting the Currency and Currency Factor .....	85
7.2.7 Changing a User Password .....	87
7.2.8 Setting Communications Parameters .....	89
7.2.9 Setting Protection Parameters .....	91
7.2.10 Setting Feature Parameters .....	93
7.2.11 Setting Isolation Parameters .....	95
7.2.12 Manually Starting and Shutting down the SUN2000 .....	97
7.2.13 Restoring Factory Settings .....	99
7.2.14 Enabling USB Guide Functions .....	101
7.2.15 Cleaning the User Data .....	104
7.2.16 Resetting Alarms .....	106
7.2.17 Resetting the System .....	107
7.2.18 Viewing the System Version .....	109
<b>8 Maintenance .....</b>	<b>111</b>
8.1 Powering Off the SUN2000 .....	111
8.2 Routine Maintenance .....	112
8.3 Troubleshooting .....	113
<b>9 SUN2000 Handling .....</b>	<b>119</b>
9.1 SUN2000 Removal .....	119
9.2 SUN2000 Packing .....	119
9.3 Disposing the SUN2000 .....	119
<b>10 Technical Specifications .....</b>	<b>120</b>
<b>A Acronyms and Abbreviations .....</b>	<b>125</b>
<b>B Power Grid Codes .....</b>	<b>127</b>

---

# 1 Safety Precautions

---

Strictly follow all the safety precautions in this document to prevent personal injury or death.

## Personnel Requirements

- Only qualified and trained electrical technicians are allowed to operate the SUN2000.
- Operators should understand the components and functioning of a grid-tied PV power system, and they should be familiar with relevant local standards.

## Label Protection

- Do not tamper with any warning signs on the SUN2000 enclosure because these signs contain important information about safe operation.
- Do not remove or damage the nameplate on the SUN2000 enclosure because it contains important product information.

## Installation



### DANGER

Ensure that DC and AC power supplies are disconnected before operations.

---



### NOTICE

Read this document before installation. Huawei shall not be liable for any consequence caused by violation of the regulations specified in this document.

---

- Shield the PV modules with opaque cloth before connecting cables to the SUN2000.
- Ensure that the SUN2000 is not connected to a power supply and is not powered on before starting installation.
- Ensure that there are no objects within 200 mm of both sides of the SUN2000, and no objects within 500 mm, 600 mm, and 1000 mm of the top, bottom, and front, respectively. This is to allow sufficient space for installation and heat dissipation.



- Install the SUN2000 in an environment with good ventilation to ensure efficient and long-term system performance.
- Ensure that the SUN2000 heat sinks are free from blockage.
- Do not touch any components except the wiring terminals at the bottom inside the enclosure.

## Electrical Connection



### DANGER

Before connecting cables to the SUN2000, ensure that the SUN2000 is securely positioned and not damaged in any way. Otherwise, electrical shock or fire may occur.

- Ensure that all electrical connections comply with local electrical standards.
- Obtain approval from the local power supply department before using the SUN2000 to generate electricity in grid-tied mode.
- Ensure that the cables to the solar power system are properly connected and insulated and meet specifications. Confirm that the insulation resistance between the ground and the main circuit formed by the PV module strings, the SUN2000, and protective devices is at least 1 megohm.

## Operation



### DANGER

High voltage may cause electrical shock or death during operation. Strictly comply with the safety precautions in this document and associated documents when operating the SUN2000.

- Do not disconnect the DC power supply during the SUN2000 operation.
- Do not touch parts of the SUN2000 other than the liquid crystal display (LCD) and **DC SWITCH**. The SUN2000 enclosure and heat sinks are extremely hot when the SUN2000 is in operation and touching these parts can cause severe burns and personal injury.
- Ensure that only qualified personnel are allowed to set initialization parameters during the first power-on of the SUN2000. Incorrect settings may affect the SUN2000 operation and cause the SUN2000 to conflict with local certifications.
- Follow local laws and regulations when operating the device.

## Maintenance and Replacement

- Before performing maintenance tasks, power off the SUN2000 by referring to [8.1 Powering Off the SUN2000](#). Then wait for at least 5 minutes before performing operations on the SUN2000.
- Place temporary warning signs or erect fences to prevent unauthorized access to the maintenance site.

- Rectify any faults that may compromise the SUN2000 security performance before restarting the SUN2000.
- A faulty SUN2000 requires overall maintenance. Contact the dealer if the SUN2000 is faulty.
- Maintain the SUN2000 with sufficient knowledge of this document and proper tools and testing equipment.
- Wear electrostatic discharge (ESD) gloves and comply with ESD protection regulations when maintaining the SUN2000.

# 2 Overview

This chapter introduces the SUN2000 and describes its functioning, appearance, label conventions, and monitoring panel.

## 2.1 Introduction

This section describes the functions, models, and application of the SUN2000.

### Function

The SUN2000 is a three-phase grid-tied PV string inverter. It converts DC power generated by PV strings into AC power and then feeds the AC power into the power grid.

### Models

Figure 2-1 shows how to read the SUN2000 model number, using SUN2000-17KTL as an example.

Figure 2-1 Model number description

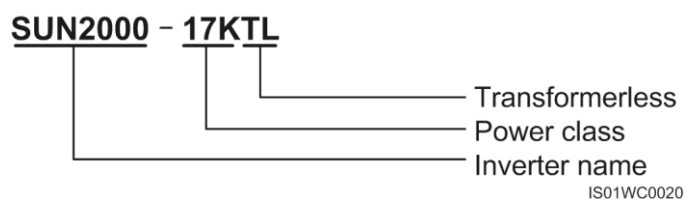


Table 2-1 lists all the models of the SUN2000 and their rated output power.

Table 2-1 SUN2000 models and rated output power

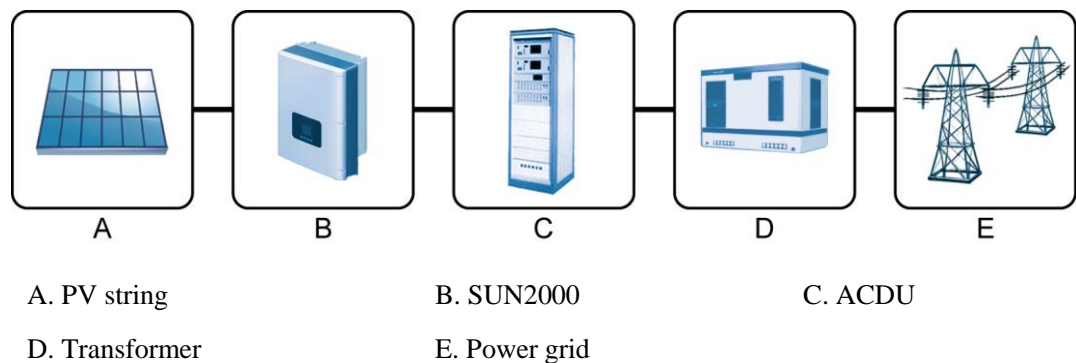
Model	Rated Output Power
SUN2000-8KTL	8 kW
SUN2000-10KTL	10 kW

Model	Rated Output Power
SUN2000-12KTL	12 kW
SUN2000-15KTL	15 kW
SUN2000-17KTL	17 kW
SUN2000-20KTL	20 kW
SUN2000-23KTL	23 kW
SUN2000-28KTL	27.5 kW

## Network Application

The SUN2000 applies to grid-tied PV power systems for commercial rooftops and large power stations. A typical grid-tied PV power system consists of PV strings, grid-tied inverters, and AC distribution units (ACDUs), as shown in [Figure 2-2](#).

**Figure 2-2** SUN2000 network application



**NOTE**

A model in the range from SUN2000-8KTL to SUN2000-23KTL can connect to the low-voltage power grid directly without connecting to a transformer.

## Power Grid Modes for the SUN2000

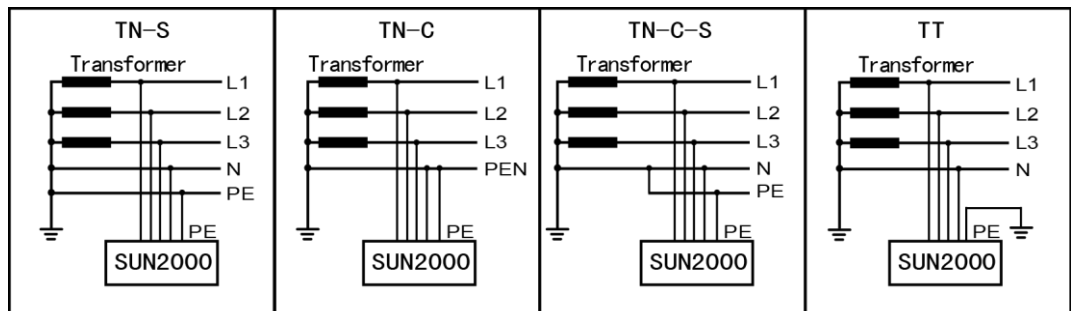
All SUN2000 models except the SUN2000-28KTL support the power grid modes TN-S, TN-C, TN-C-S, and TT, as shown in [Figure 2-3](#). The SUN2000-28KTL supports the IT mode, as shown in [Figure 2-4](#).

 **NOTICE**

- The valid neutral-ground voltage for the TT grid mode must be less than 30 V.
- The SUN2000-28KTL applies to medium-voltage and low-voltage power grids. If the output voltage of the SUN2000 (three-phase, with a PE cable, 480 V) does not match the power grid voltage, connect a transformer to adapt to the power grid voltage.

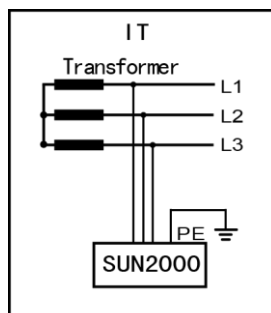
For example, if the SUN2000 is connected to a low-voltage power grid (three-phase, with an N cable and a PE cable, 400 V), a transformer is required to convert the 480 V voltage to the 400 V voltage.

**Figure 2-3** Power grid modes supported by all SUN2000 models except the SUN2000-28KTL



IS01SC0004

**Figure 2-4** Power grid mode supported by the SUN2000-28KTL



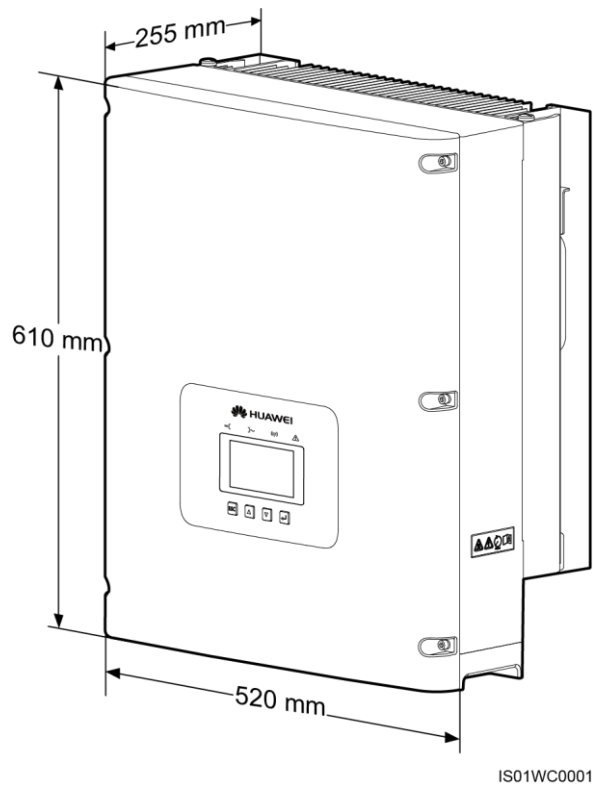
IS01SC0005

## 2.2 Appearance

This section describes the appearance and specifications of the SUN2000.

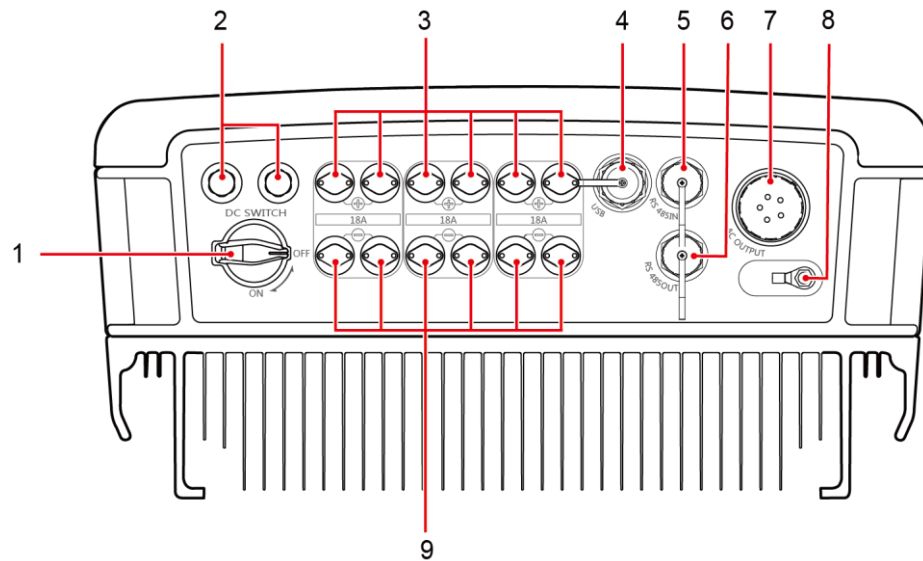
## External Dimensions

Figure 2-5 Appearance



## Bottom View

Figure 2-6 Ports



IS01WC0004

- |                        |                                   |                                   |
|------------------------|-----------------------------------|-----------------------------------|
| (1) DC switch          | (2) Ventilation valves            | (3) DC input terminals (positive) |
| (4) USB port           | (5) RS485 IN port                 | (6) RS485 OUT port                |
| (7) AC output terminal | (8) Protective earthing (PE) bolt | (9) DC input terminals (negative) |


## 2.3 Label Conventions






This section describes the symbols on the SUN2000 and the nameplate.

### Symbols

Table 2-2 describes all symbols on the SUN2000.

Table 2-2 Symbols

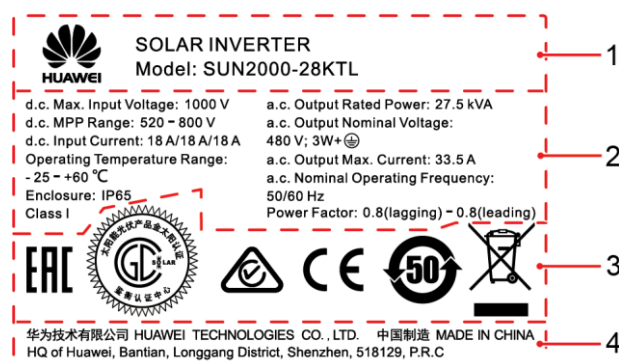
Symbol	Label	Meaning
	Danger high voltage	The SUN2000 operates at high voltage. All operations on the SUN2000 may only be carried out by a trained electrician.

Symbol	Label	Meaning
	Delay discharge	Any residual voltage in the SUN2000 takes 5 minutes to fully discharge.
	Burn warning	The SUN2000 must not be touched when in operation because its enclosure and heat sinks are extremely hot.
	Refer to documentation	Remind operators to refer to the documentation shipped with the SUN2000.
	Grounding	The SUN2000 must be connected to a ground bar for grounding purposes.
	Operation warning	The DC input connector must not be removed when the SUN2000 is in operation.

## Nameplate

Figure 2-7 shows the SUN2000 nameplate, which contains the model information, technical specifications, and compliance symbols.

Figure 2-7 Nameplate



(1) Trademark, product name, and model number

(2) Technical specifications

(3) Compliance symbols

(4) Company name and country of manufacture









**NOTE**

The nameplate figure is for reference only. The actual nameplate prevails.

Table 2-3 describes the compliance symbols.

**Table 2-3** Compliance symbols on the nameplate

Symbol	Name	Meaning
	CGC-Solar certification mark	The SUN2000 complies with CGC-Solar certification standards.  Note: The SUN2000-8KTL, SUN2000-10KTL, and SUN2000-12KTL do not feature.
	CE certification mark	The SUN2000 complies with CE certification standards.
	Environmentally friendly use period (EFUP)	The SUN2000 is environmentally friendly for at least 50 years.
	EU WEEE mark	The SUN2000 must not be disposed of as domestic waste.

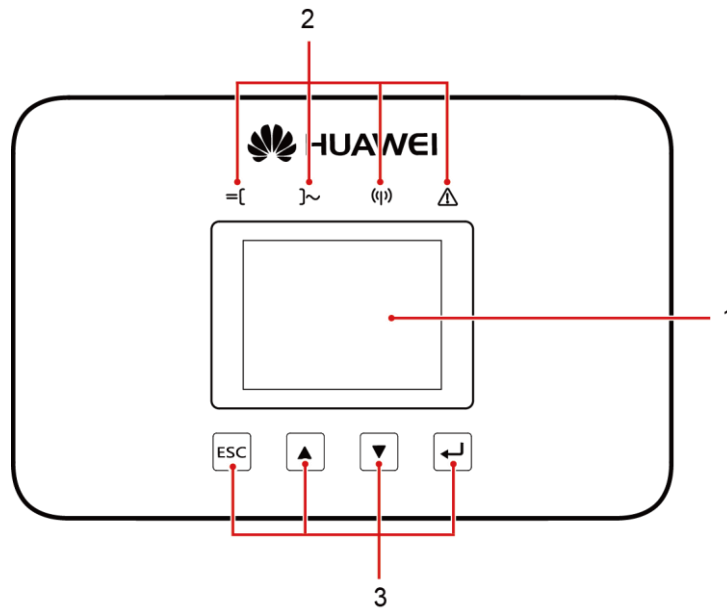
## 2.4 Monitoring Panel

This section describes the monitoring panel, including the LCD, LED indicators, buttons, and the default screen displayed on the LCD.

### Appearance

The monitoring panel has an LCD, four indicators, and four buttons, as shown in [Figure 2-8](#).

**Figure 2-8** Monitoring panel



(1) LCD

(2) Indicators

(3) Buttons



**NOTE**

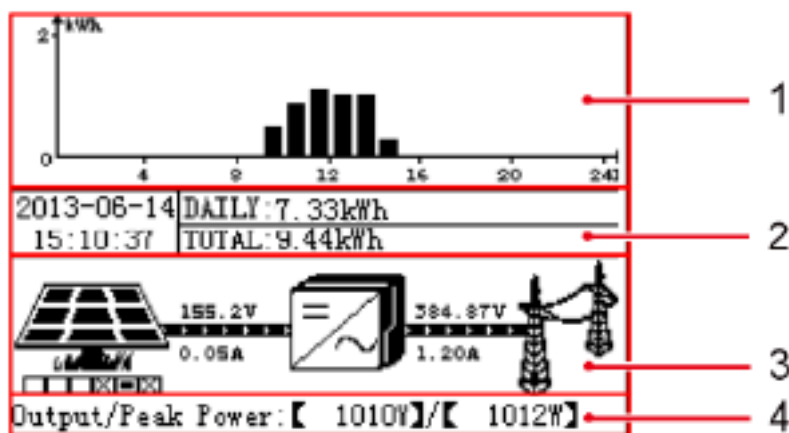
The LCD displays SUN2000 operating data such as input power, output power, energy yield, and alarms. The indicators show the SUN2000 operating status.

## LCD

The LCD displays the SUN2000 data in graphics and text, including the operating information, alarm information, system parameters, and user parameters.

If no button is pressed within 90s on a non-default screen, the LCD automatically displays the default screen, which is shown in [Figure 2-9](#).

**Figure 2-9** Default page







(1) Energy yield histogram	The energy yield for each hour of the current day.
(2) Energy yield data	<ul style="list-style-type: none"> <li>The current date and time.</li> <li>The total energy yield for the current day from 00:00 to the current time.</li> <li>The total energy yield from the initial startup to the current time.</li> </ul>
(3) Power flow diagram	<ul style="list-style-type: none"> <li>The number of PV string inputs. This is represented by the row of boxes under the PV module icon. <ul style="list-style-type: none"> <li>A box with a cross indicates a PV string that is not connected or has low power.</li> <li>A box marked white or black indicates a PV string that is working normally.</li> </ul> </li> <li>The power flow from the PV strings to the SUN2000 and the voltage and current of each input.</li> <li>The power flow from the SUN2000 to the power grid and the voltage and current of each output. <ul style="list-style-type: none"> <li>All models except the SUN2000-28KTL display the effective phase voltage and current of the SUN2000 three-phase output.</li> <li>The SUN2000-28KTL displays the effective line voltage and current.</li> </ul> </li> </ul> <p><b>NOTE</b> The system displays the voltage and current from the PV string corresponding to the box marked black and switches between the connected PV strings every 10 seconds. Manual switching can be performed by pressing ▲ and ▼.</p>
(4) Output/Peak power	The output power and peak power of the SUN2000.

## Indicators

Table 2-4 describes the four indicators on the SUN2000 monitoring panel.

**Table 2-4** Indicator description




Indicator	State	Meaning
PV connection indicator 	Steady green	The SUN2000 is properly connected to at least one PV string.
	Off	The SUN2000 is disconnected from all PV strings.
Grid-tie indicator 	Steady green	The SUN2000 is properly connected to the power grid.
	Off	The SUN2000 is disconnected from the power grid.

Indicator	State	Meaning
Communications indicator 	Blinking green fast (on for 0.5s and then off for 0.5s for three times at an interval of 10s)	The SUN2000 is communicating properly.
	Off	No communication is in progress or the communication is abnormal.
Alarm indicator 	Steady red	The SUN2000 generates a major alarm. For details, see <a href="#">7.2.2 Viewing Alarm Records</a> .
	Blinking red at short intervals (on for 0.5s and then off for 0.5s)	The SUN2000 generates a minor alarm. For details, see <a href="#">7.2.2 Viewing Alarm Records</a> .
	Blinking red at long intervals (on for 1s and then off for 4s)	The SUN2000 has generated a warning. For details, see <a href="#">7.2.2 Viewing Alarm Records</a> .

## Buttons

[Table 2-5](#) describes the four buttons on the SUN2000 monitoring panel.

**Table 2-5** Button description

Button	Name
ESC	Escape
	Up
	Down
	Confirm

 **NOTE**

The backlight lasts for 60s after any button is pressed.

## 2.5 Working Principles

This section describes the circuit diagrams and working modes of the SUN2000.

### Conceptual Diagrams

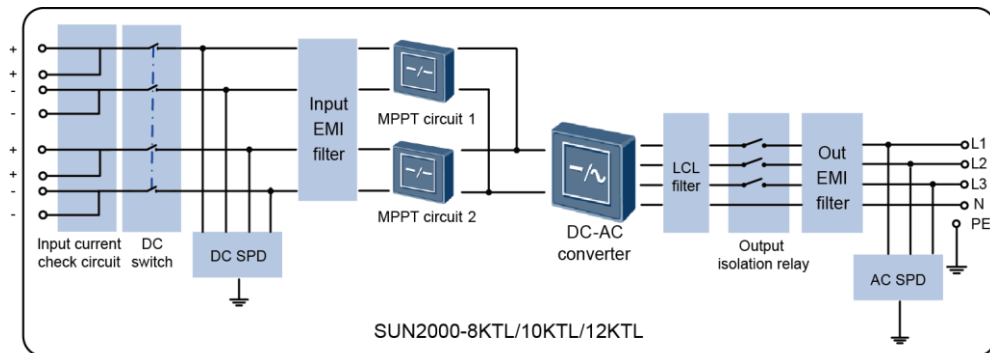
- The SUN2000-15KTL, SUN2000-17KTL, SUN2000-20KTL, SUN2000-23KTL, and SUN2000-28KTL receive inputs from six PV strings. The inputs are then grouped into

three maximum power point tracking (MPPT) routes inside the SUN2000 to track the maximum power point of the PV strings.

- The SUN2000-8KTL, SUN2000-10KTL, and SUN2000-12KTL receive inputs from four PV strings. The inputs are then grouped into two MPPT routes inside the SUN2000 to track the maximum power point of the PV strings.

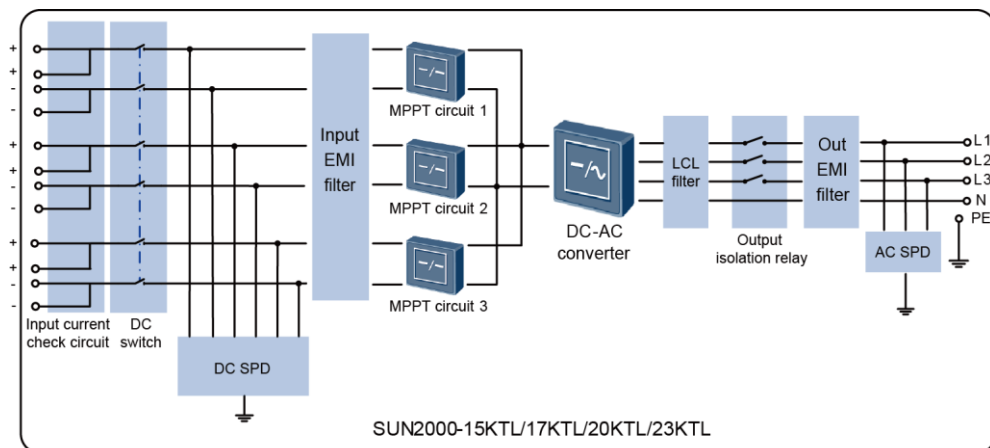
The DC power is then converted into three-phase AC power through a converter circuit. There is surge protection for both DC and AC sides. Figure 2-10, Figure 2-11, and Figure 2-12 show the circuit diagrams for the different models.

**Figure 2-10** Conceptual diagram for the SUN2000-8KTL, SUN2000-10KTL, and SUN2000-12KTL



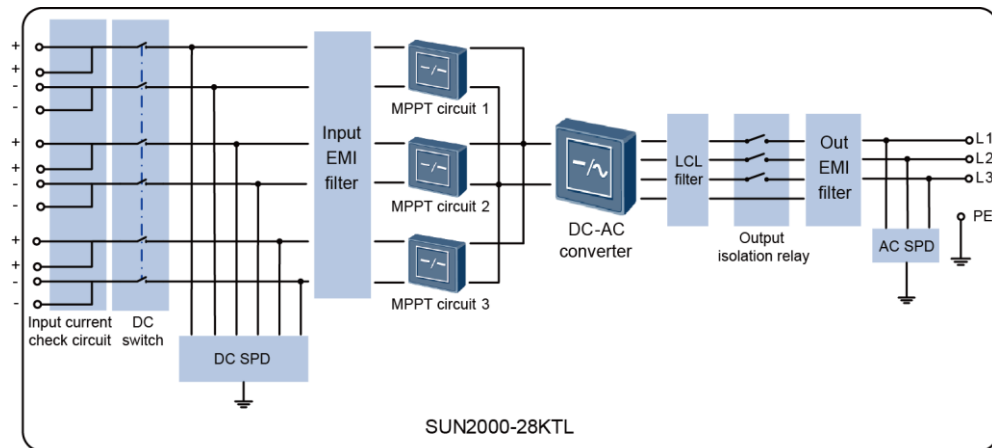
IS01PC0001

**Figure 2-11** Conceptual diagram for the SUN2000-15KTL, SUN2000-17KTL, SUN2000-20KTL, and SUN2000-23KTL



IS01PC0002

**Figure 2-12** Circuit diagram for the SUN2000-28KTL



IS01PC0010

Each component of the SUN2000 works as follows:

- The input current check circuit determines the operating status of each PV string and generates an alarm prompting for repair if a PV string is not working properly.
- The DC switch can be used to disconnect internal circuits from the DC input of the SUN2000 to facilitate manual operations during maintenance.
- The class II DC surge protective device (SPD) provides a discharge loop for DC overvoltage to protect SUN2000 internal circuits against the impact of power surges.
- The input and output electromagnetic interference (EMI) filters remove EMI from the SUN2000 to meet electromagnetic compatibility requirements.
- The MPPT circuits measure the voltage and current of the PV strings in real time and track the maximum power point to ensure maximum output power of the system.
- The DC-AC converter circuit converts DC power into AC power which is then fed to the power grid with equivalent output frequency and voltage.
- The LCL filter removes high-frequency components from the output current of the SUN2000 to ensure that the output current meets power grid requirements.
- The output isolation relay isolates the AC output of the SUN2000 from the power grid if either of them is faulty.
- The class II AC SPD provides a discharge loop for AC overvoltage to protect the SUN2000 internal circuits against the impact of power surges.

## Working Modes

Figure 2-13 shows the changes in conditions that cause the SUN2000 to switch between working modes.

**Figure 2-13** Working modes

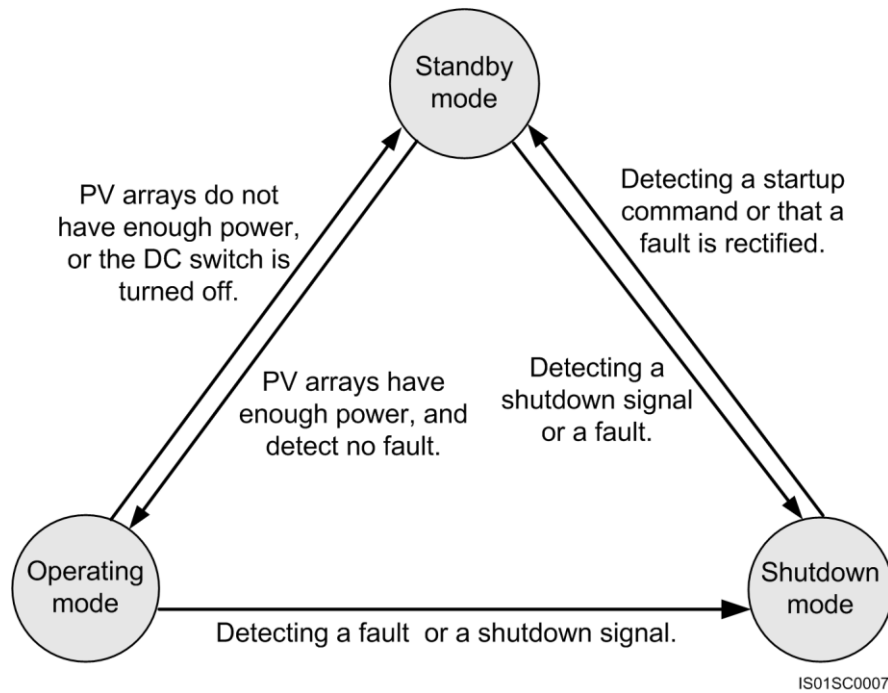


Table 2-6 describes the working modes shown in Figure 2-13.

**Table 2-6** Working mode description

Working Mode	Description
Standby	<p>The SUN2000 enters standby mode when the external environment does not meet the SUN2000 operation requirements. In this mode, the SUN2000 continuously performs a self-check and enters operating mode once operation requirements are met.</p> <p>The SUN2000 switches to shutdown mode when it detects a shutdown command or a fault.</p>
Operating	<p>In this mode:</p> <ul style="list-style-type: none"> <li>The SUN2000 converts DC power from PV strings into AC power and feeds the power to the power grid.</li> <li>The SUN2000 always tracks the maximum power point to maximize the PV string output.</li> <li>The SUN2000 enters the shutdown mode after detecting a fault or a shutdown command, and enters the standby mode after detecting that the PV string output power does not meet the requirements for grid-tied electricity generation.</li> </ul>
Shutdown	<p>The SUN2000 switches from standby or operating mode to shutdown mode when it detects a fault or a shutdown command.</p> <p>The SUN2000 switches to standby mode when it receives a startup command or when it detects that a fault is rectified.</p>

# 3 SUN2000 Storage

---

This chapter describes SUN2000 storage requirements.

The following storage instructions apply if the SUN2000 will not be deployed immediately:

- Do not unpack the SUN2000.
- Store the SUN2000 at a temperature range of -40 °C to +70 °C and with the relative humidity of 5% to 95%.
- The SUN2000 should be stored in a clean and dry place and be protected from dust and water vapor corrosion.
- Do not stack more than four SUN2000s.
- Conduct periodic inspection during storage. Replace the packing materials immediately if any rodent bites are found.
- Ensure that qualified personnel inspect and test the SUN2000 before use if it has been stored for a long time.



# 4 Installation

This chapter describes how to install the SUN2000.

## Context



### **DANGER**

- Do not install the SUN2000 on flammable building materials.
  - Do not store the SUN2000 in areas with flammable or explosive materials.
- 



### **CAUTION**

Do not install the SUN2000 in places prone to body contact because the SUN2000 shelf and heat sinks become hot during the SUN2000 operation.

---

## 4.1 Checking Before Installation

Before unpacking, check that the outer packing is intact. After unpacking, check that the product and accessories are intact and complete.

### Checking Outer Packing Materials

Before unpacking the SUN2000, examine the outer packing for damage such as holes and cracks. If any such damage is found, do not unpack the SUN2000 and contact the dealer immediately.



#### **NOTE**

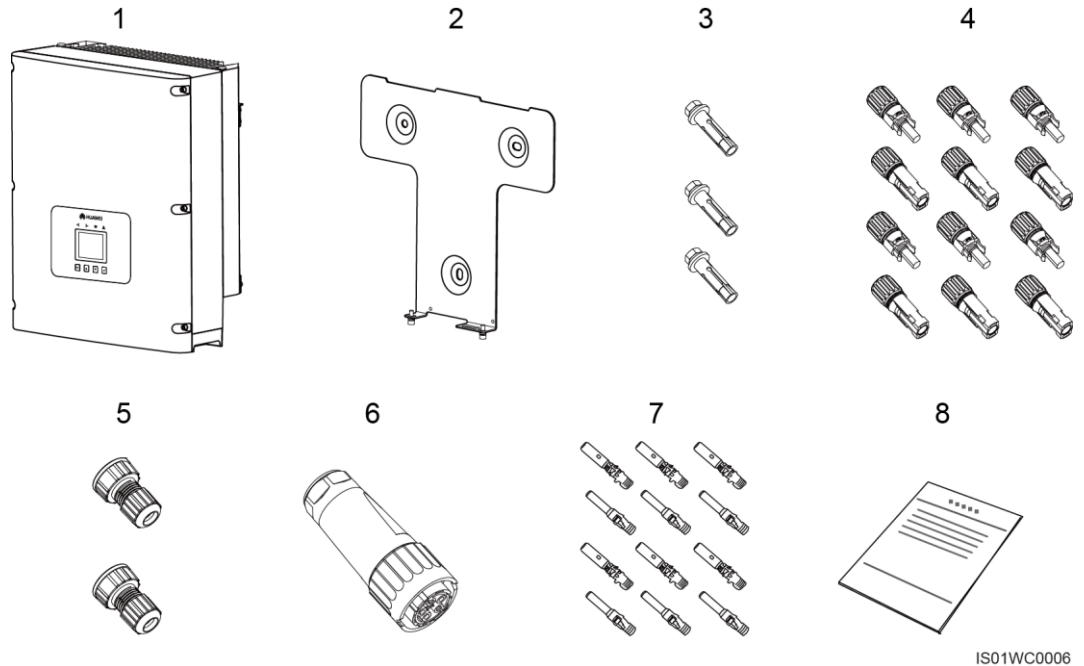
Remove the outer packing only 24 hours before installation.

## Checking the Product and Accessories

After unpacking the SUN2000, check the product and accessories. If any damage is found or any component is missing, contact the dealer.

Figure 4-1 shows the product and accessories included in the delivery.

**Figure 4-1** Product and accessories

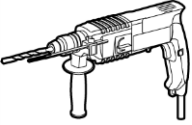

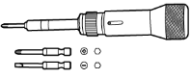



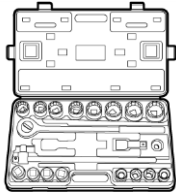
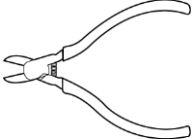
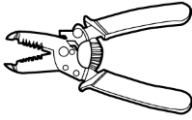

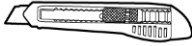

No.	Name	Quantity	Description
1	SUN2000	1	N/A
2	Rear panel	1	N/A
3	Expansion bolt	3	Secures the rear panel to a wall.
4	DC input connector	8/12	Connects to a DC input power cable. <ul style="list-style-type: none"> <li>SUN2000-8KTL/10KTL/12KTL: 8 (4 positive connectors and 4 negative connectors)</li> <li>SUN2000-15KTL/17KTL/20KTL/23KTL/28KTL: 12 (6 positive connectors and 6 negative connectors)</li> </ul>
5	Waterproof RJ45 connector	2	Connects to a communications cable.
6	AC output connector	1	Connects to an AC output power cable.
7	Metal terminal	8/12	Secures a connector to a DC input power cable. <ul style="list-style-type: none"> <li>SUN2000-8KTL/10KTL/12KTL: 8 (4 positive</li> </ul>

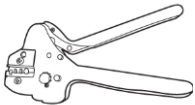
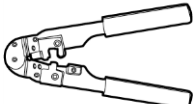
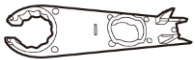


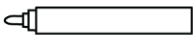
No.	Name	Quantity	Description
			metal terminals and 4 negative metal terminals) <ul style="list-style-type: none"> <li>SUN2000-15KTL/17KTL/23KTL/28KTL: 12 (6 positive metal terminals and 6 negative metal terminals)</li> </ul> <p><b>NOTICE</b> Positive and negative metal terminals are packed with positive and negative connectors respectively. After unpacking, keep the positive and negative ones separate to avoid confusion.</p>
8	Documentation	1	N/A

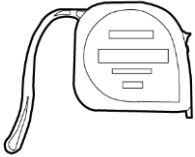

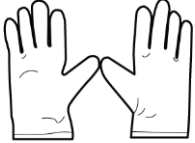


## 4.2 Tools

Prepare the tools required for installation and cable connections.

Tool	Model	Function
Hammer drill 	With a drill bit of $\Phi 14$ mm	Drills holes.
Adjustable wrench 	With an open end $\geq 32$ mm	Tightens expansion bolts.
Torque screwdriver 	<ul style="list-style-type: none"> <li>Hexagon socket head: 5 mm</li> <li>Flat head: M6</li> </ul>	<ul style="list-style-type: none"> <li>Hexagon socket head: Secures screws to mechanical parts.</li> <li>Flat head: Removes plastic screws from lifting holes.</li> </ul>
Flat-head screwdriver 	3 x 100 <ul style="list-style-type: none"> <li>Head width: 3-3.5 mm</li> <li>Pole length (excluding the handle): at least 100 mm</li> <li>Large handle</li> </ul>	<ul style="list-style-type: none"> <li>Tightens or loosens screws when installing AC power cables.</li> <li>Removes AC connectors from the SUN2000.</li> </ul>

Tool	Model	Function
<p>Socket wrench</p> 	<p>With an open end of 10 mm</p>	<p>Tightens ground bolts.</p>
<p>Diagonal pliers</p> 	<p>N/A</p>	<p>Cut cable ties.</p>
<p>Wire stripper</p> 	<p>Applies to cables with cross-sectional areas of 4 mm<sup>2</sup>, 6 mm<sup>2</sup>, and 10 mm<sup>2</sup></p>	<p>Peels off cable jackets.</p>
<p>Rubber mallet</p> 	<p>N/A</p>	<p>Hammers expansion bolts into holes.</p>
<p>Guarded blade utility knife</p> 	<p>N/A</p>	<p>Removes packaging.</p>
<p>Cable cutter</p> 	<p>Applies to cables with cross-sectional areas of 4 mm<sup>2</sup>, 6 mm<sup>2</sup>, and 10 mm<sup>2</sup></p>	<p>Cuts power cables.</p>

Tool	Model	Function
<p>Crimping tools</p> 	<p>H4TC0001 Manufacturer: AMPHENOL</p>	<p>Crimps cables.</p>
<p>RJ45 crimping tool</p> 	<p>N/A</p>	<p>Prepares RJ45 connectors for communications cables.</p>
<p>Removal tool</p> 	<p>H4TW0001 Manufacturer: AMPHENOL</p>	<p>Removes DC connectors from the SUN2000.</p>
<p>Vacuum cleaner</p> 	<p>N/A</p>	<p>Cleans up dust after drilling holes.</p>
<p>Multimeter</p> 	<p>N/A</p>	<p>Measures voltage.</p>
<p>Marker</p> 	<p>Diameter: maximum 10 mm</p>	<p>Marks signs.</p>

Tool	Model	Function
Measuring tape 	N/A	Measures distances.
Level 	N/A	Checks the levelness of the rear panel.
ESD gloves 	N/A	Protect operators when drilling holes.
Safety goggles 	N/A	Protect operators when drilling holes.
Anti-dust respirator 	N/A	Protects operators from dust inhalation when drilling holes.

### 4.3 Determining the Installation Position

The requirements described in this section apply to both wall mounting and support mounting. This section uses wall-mounting the SUN2000 as an example.

Comply with the following requirements when determining an appropriate position to install the SUN2000:



## DANGER

- Do not install the SUN2000 on flammable building materials.
  - Do not install the SUN2000 in an area that stores flammable or explosive materials.
- 



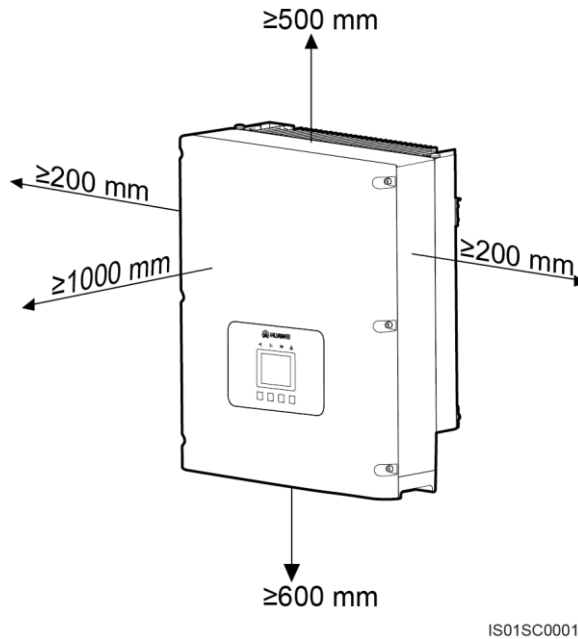
## CAUTION

Do not install the SUN2000 in a place where personnel are likely to come into contact with its enclosure and heat sinks. These parts are extremely hot during operation.

---

- The SUN2000 is protected to IP65 and can be installed indoors or outdoors.
- The installation method and position must be appropriate for the weight and dimensions of the SUN2000. For details, see [10 Technical Specifications](#).
- The wall must be solid enough to support the weight of the SUN2000.
- The cable connection area must face downwards.
- Install the SUN2000 either vertically or with a backward lean of a maximum of 15 degrees.
- The SUN2000 must be installed at an appropriate height for ease of observation and operation of the monitoring panel.
- The SUN2000 must be installed in a well ventilated environment to ensure good heat dissipation. When installed under direct sunlight, performance de-rate may be initiated due to additional temperature rise.
- Do not install the SUN2000 on a wall made of gypsum boards or similar materials with weak sound insulation, to avoid noise disturbance in a residential area.
- Ensure that there are no objects within 200 mm of both sides of the SUN2000, and no objects within 500 mm, 600 mm, and 1000 mm of the top, bottom, and front, respectively (as shown in [Figure 4-2](#)). This is to ensure optimal heat dissipation and sufficient space for installation.

**Figure 4-2** Minimum installation clearance



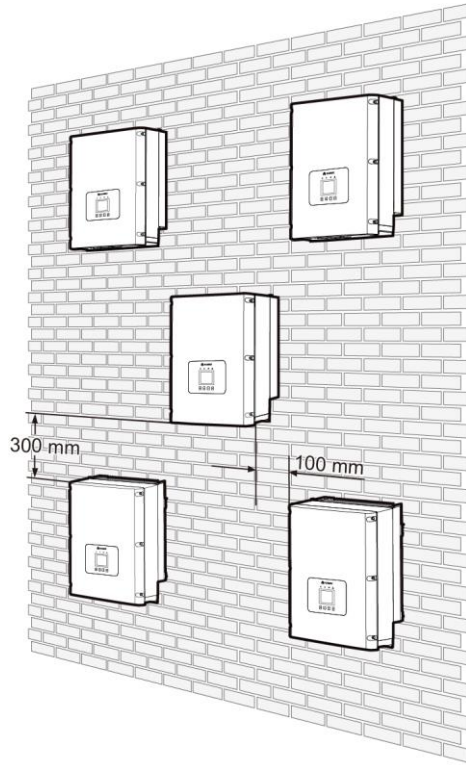
### NOTICE

The minimum installation clearance shown in [Figure 4-2](#) must be provided in any installation scenario, including wall-mounted and support-mounted scenarios.

- Multiple SUN2000s must be installed in a line if sufficient space is available. Otherwise, they must be installed in checkerboard mode as shown in [Figure 4-3](#). The stacked installation mode shown in [Figure 4-4](#) is not recommended. The clearance between SUN2000s must meet requirements shown in the following figures.

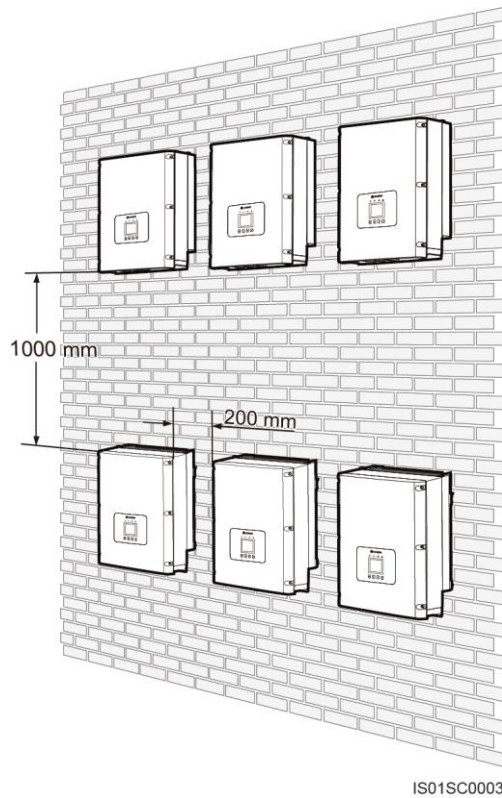


**Figure 4-3** Checkerboard installation mode (recommended)



IS01SC0002

**Figure 4-4** Stacked installation mode (not recommended)



## NOTICE

The clearance between multiple SUN2000s must be increased to ensure proper heat dissipation when they are installed in a hot area.

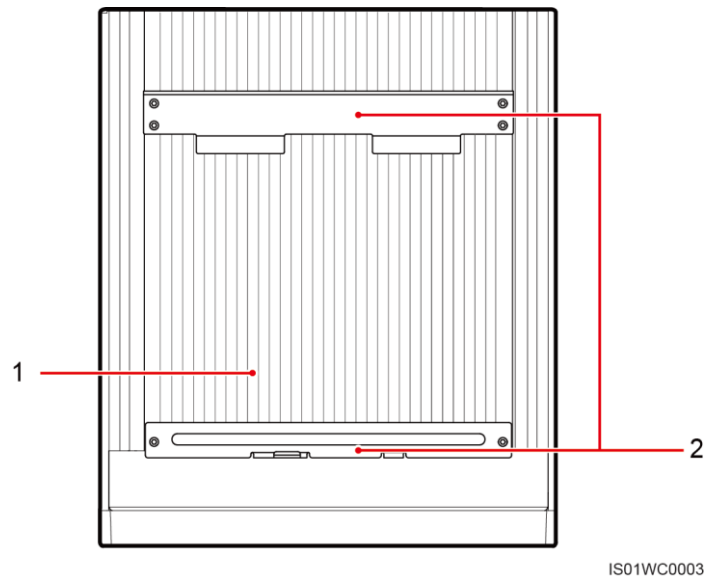
## 4.4 Support-mounting the SUN2000

When installing the SUN2000, the accompanying rear panel must first be secured to a support. The SUN2000 is then secured to the rear panel using hexagon screws.

### Context

[Figure 4-5](#) shows the SUN2000 from the back.

Figure 4-5 SUN2000 rear view

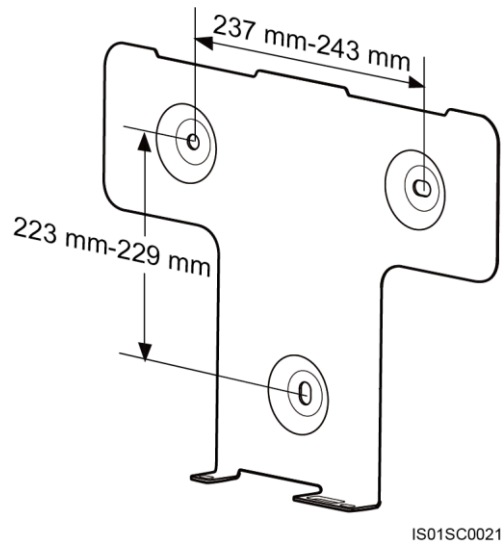


(1) Heat sink

(2) Mounting bracket

Figure 4-6 shows the dimensions of holes in the rear panel of the SUN2000.

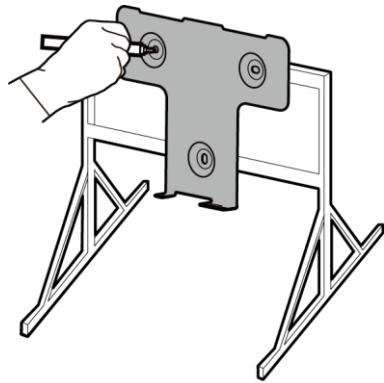
Figure 4-6 Dimensions of holes in the SUN2000 rear panel



## Procedure

**Step 1** Determine the positions for drilling holes using the rear panel in the packing case, and mark the hole positions using a marker, as shown in Figure 4-7.

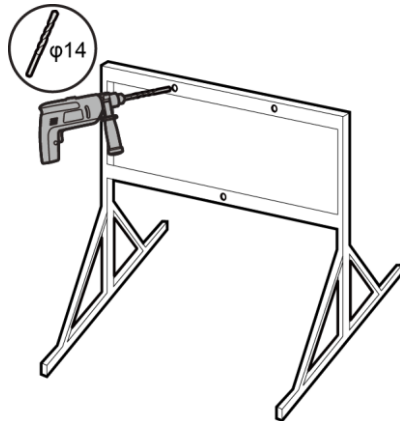
**Figure 4-7** Determining hole positions



IS01HC0016

**Step 2** Drill holes using a hammer drill, as shown in [Figure 4-8](#).

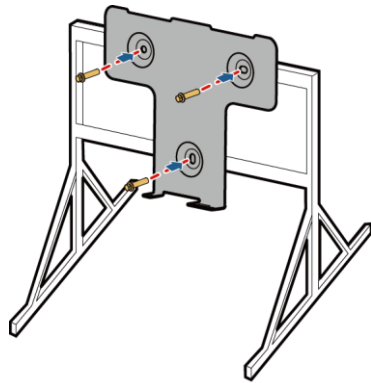
**Figure 4-8** Drilling holes



IS01HC0017

**Step 3** Align the rear panel with hole positions, insert M10x60 bolts into the holes, and tighten the bolts to a torque of 30 N·m using a torque wrench, as shown in [Figure 4-9](#).

**Figure 4-9** Securing a rear panel



IS01HC0012

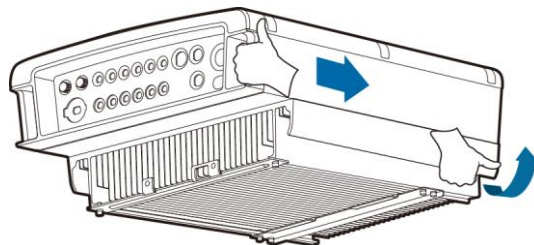
**Step 4** Hold the handle at the bottom of the SUN2000 with one hand and hold the end of the other handle near the SUN2000 top with the other end, and then stand the SUN2000, as shown in [Figure 4-10](#). Two persons are required to install the SUN2000.



**CAUTION**

To prevent personal injury caused by a falling SUN2000, keep balance when lifting the SUN2000 because the SUN2000 has a heavy top.

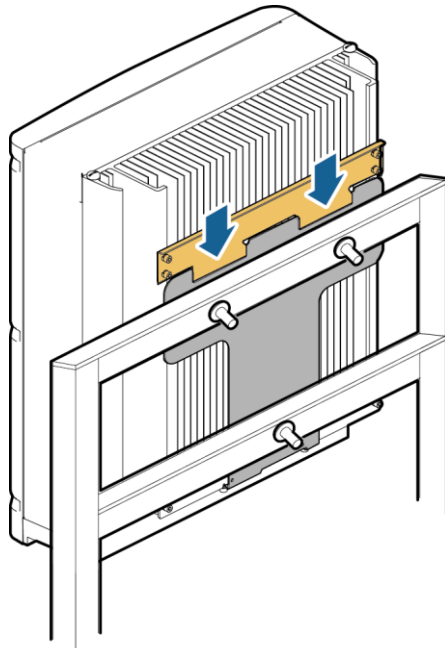
**Figure 4-10** Lifting a SUN2000



IS01HC0006

**Step 5** Mount the SUN2000, keeping the mounting brackets in alignment with the rear panel, as shown in [Figure 4-11](#).

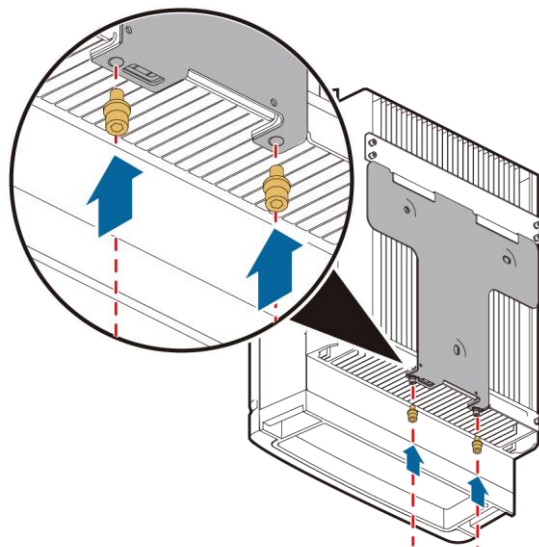
**Figure 4-11** Mounting a SUN2000 on a rear panel



IS01HC0013

**Step 6** Tighten the two hexagon screws at the bottom of the SUN2000 to a torque of 5 N m, as shown in [Figure 4-12](#).

**Figure 4-12** Tightening hexagon screws

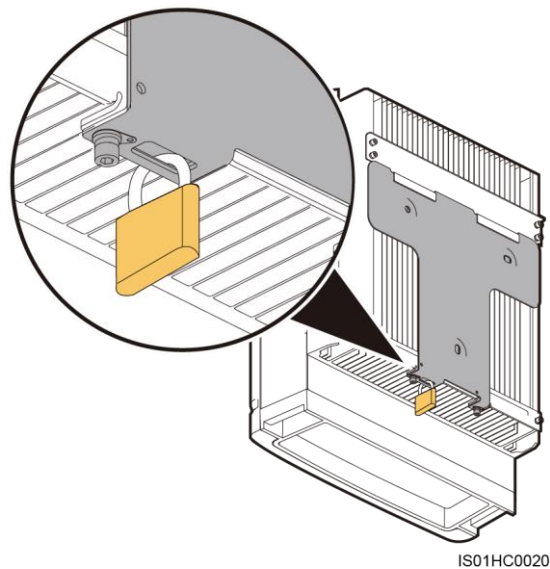


IS01HC0019

**Step 7** (Optional) Install an antitheft lock, as shown in [Figure 4-13](#).

The function of an antitheft lock is to secure the SUN2000 to the rear panel and protect it from stealing.

**Figure 4-13** Installing an antitheft lock



----End

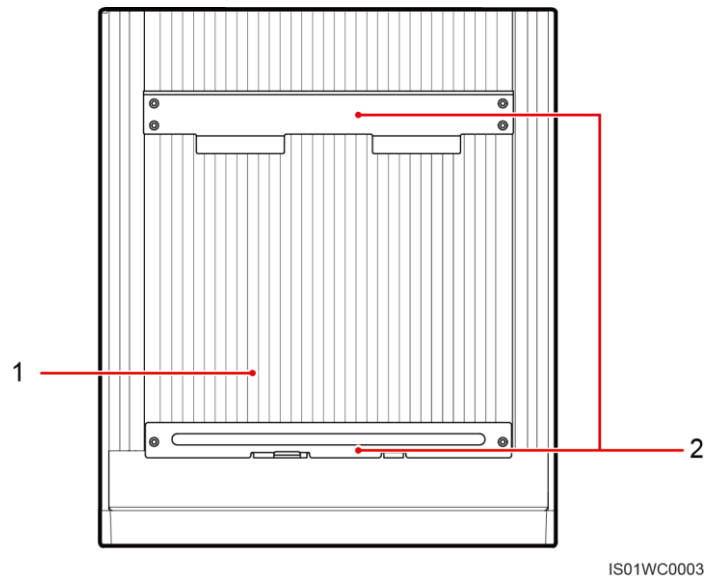
## 4.5 Wall-mounting the SUN2000

When installing the SUN2000, the accompanying rear panel must first be secured to a wall. The SUN2000 is then secured to the rear panel using hexagon screws.

### Context

[Figure 4-14](#) shows the SUN2000 from the back.

**Figure 4-14** SUN2000 rear view

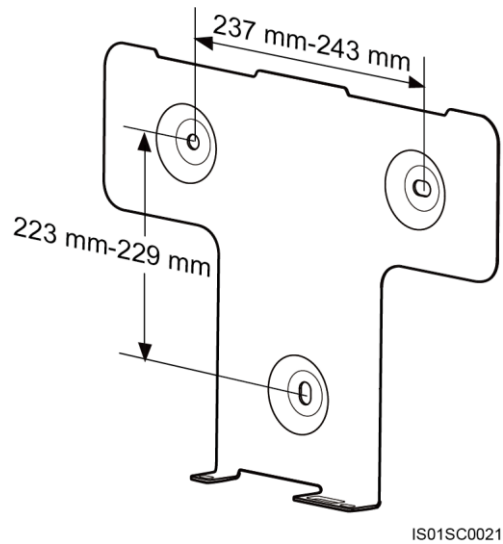


(1) Heat sink

(2) Mounting bracket

Figure 4-15 shows the dimensions of holes in the rear panel of the SUN2000.

**Figure 4-15** Dimensions of holes in the SUN2000 rear panel



**NOTE**

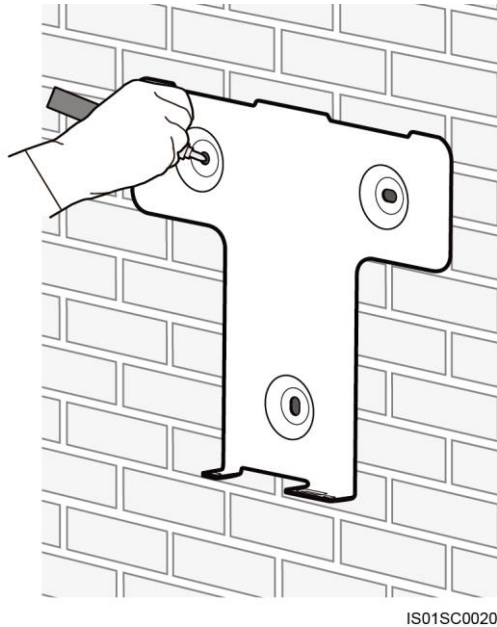
- If the installation location is near the ground, connect the PGND cable to the ground before installing the SUN2000. For details, refer to [5.1 Connecting PGND Cables](#).
- It is recommended that the SUN2000 be installed at eye level to facilitate operation and maintenance.



## Procedure

- Step 1** Locate the positions for drilling holes using the rear panel provided with the SUN2000 in the packing case, and mark the positions using a marker, as shown in [Figure 4-16](#).

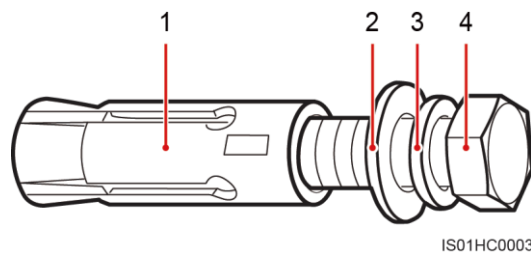
**Figure 4-16** Locating and marking the hole positions



- Step 2** Drill holes using a hammer drill and install expansion bolts, as shown in [Figure 4-18](#).

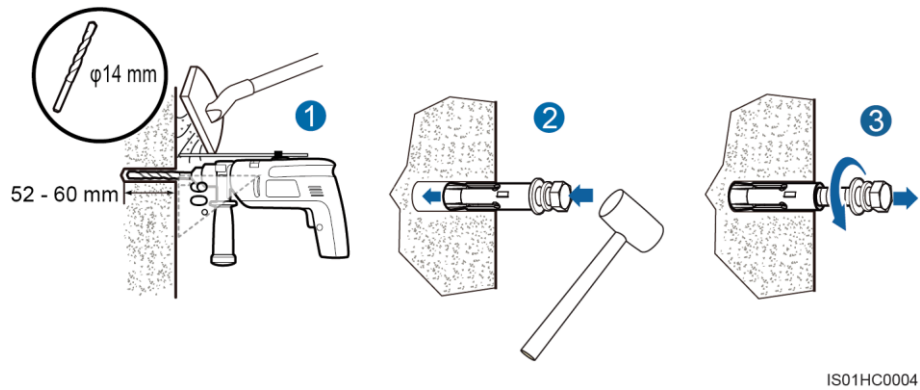
An expansion bolt is composed of four parts, as shown in [Figure 4-17](#).

**Figure 4-17** Expansion bolt composition



- (1) Expansion sleeve      (2) Flat washer      (3) Spring washer      (4) M10x60 bolt

**Figure 4-18** Drilling a hole and installing an expansion bolt



1. Drill a hole at the marked position to a depth of 52-60 mm using a hammer drill with a  $\Phi 14$  mm bit.



### CAUTION

- Wear safety goggles to prevent dust in the eyes when drilling holes. Wear an anti-dust respirator to prevent dust inhalation when drilling holes.
- Vacuum any dust in or around the holes using a vacuum cleaner and measure the distance between holes. If the holes are inaccurately positioned, drill new holes.

2. Partially tighten an expansion bolt, vertically insert it into the hole, and drive the expansion bolt completely into the hole using a rubber mallet.
3. Remove the M10x60 bolt, spring washer, and flat washer by rotating them counterclockwise.

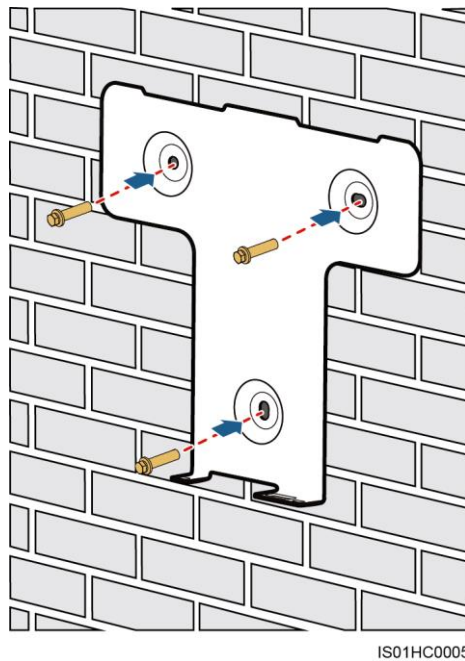


### NOTICE

Ensure that the top surface of the expansion sleeve is level with the surface of the concrete wall after removing the bolt, spring washer, and flat washer. Otherwise, the rear panel will not be securely installed on the wall.

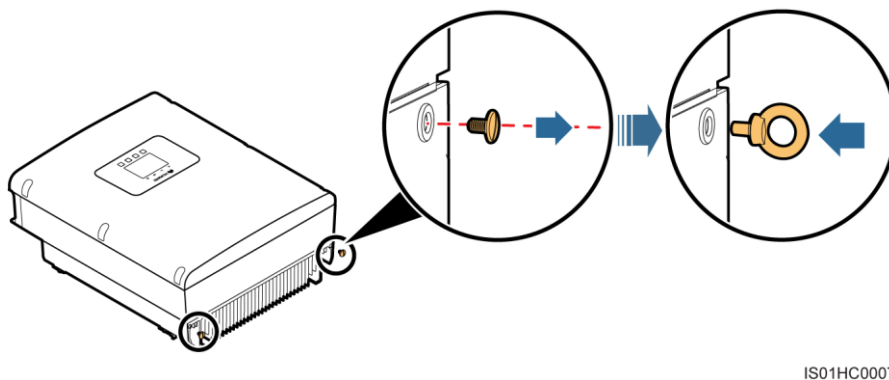
- Step 3** Align the rear panel with the holes, insert expansion bolts into the holes through the rear panel, and tighten the expansion bolts to a torque of 30 N·m using a torque wrench with a 17 mm open end, as shown in [Figure 4-19](#).

**Figure 4-19** Securing a rear panel



- Step 4** If the rear panel has been installed low enough for the SUN2000 to be mounted, go to [Step 9](#) after performing [Step 7](#).
- Step 5** If the rear panel has been installed too high for the SUN2000 to be mounted, perform [Step 6](#) to [Step 10](#).
- Step 6** Remove the two rubber screws from the top of the SUN2000 using a flat-head screwdriver and install two M10 lifting eyes, as shown in [Figure 4-20](#).

**Figure 4-20** Installing lifting eyes



- Step 7** Ensure that two people lift the SUN2000 and turn it upright. Lift the SUN2000 by grasping the handle at the bottom of the SUN2000 with one hand and the handle at the top with the other, as shown in [Figure 4-21](#).

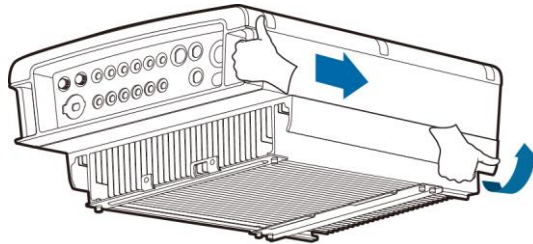


### CAUTION

To prevent personal injury, maintain balance when lifting the SUN2000 because it is top-heavy.

---

**Figure 4-21** Lifting the SUN2000



IS01HC0006

- Step 8** Run a rope that is sufficiently weight-bearing for the SUN2000 through the lifting eyes and hoist the SUN2000, as shown in [Figure 4-22](#).

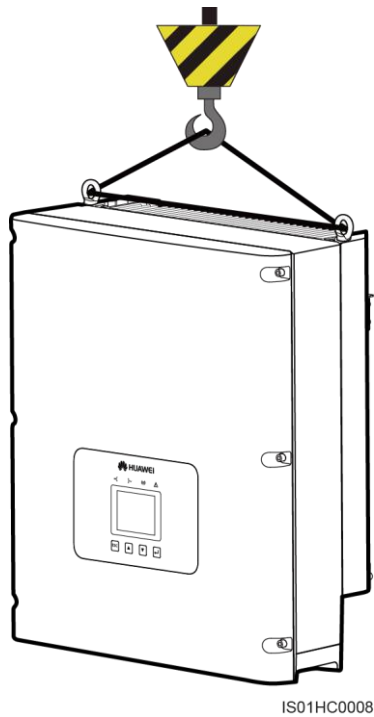


### NOTICE

When hoisting the SUN2000, maintain balance to protect the SUN2000 from knocking into the wall or other objects.

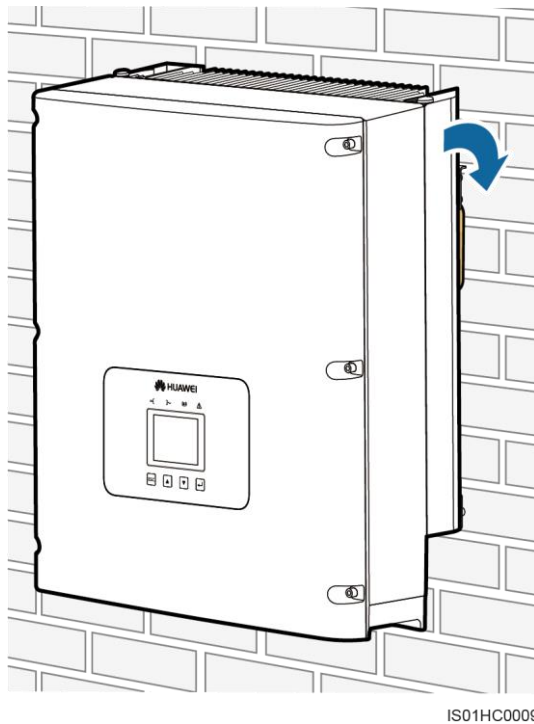
---

**Figure 4-22** Hoisting the SUN2000

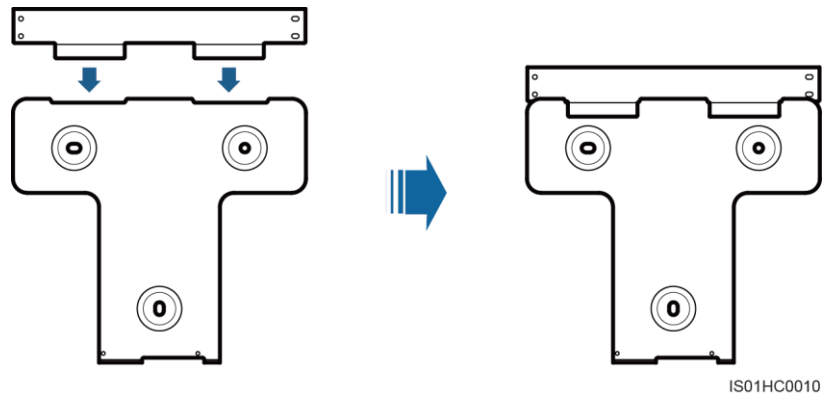


**Step 9** Mount the SUN2000, keeping the mounting brackets in alignment with the rear panel, as shown in [Figure 4-23](#) and [Figure 4-24](#).

**Figure 4-23** Mounting the SUN2000 on the rear panel (front view)

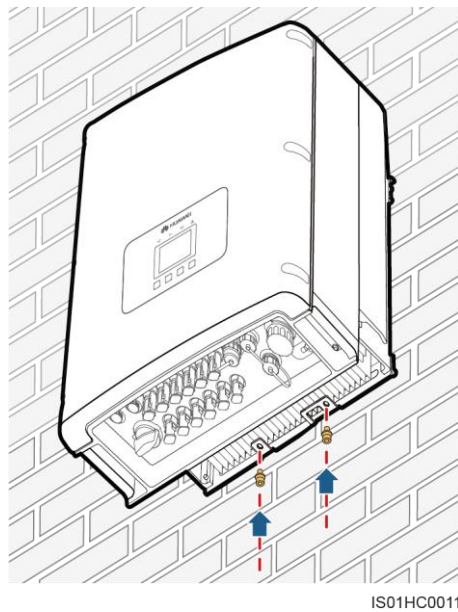


**Figure 4-24** Mounting the SUN2000 on the rear panel (rear view)



**Step 10** Tighten the two hexagon screws at the bottom of the SUN2000 to a torque of 5 N m, as shown in [Figure 4-25](#).

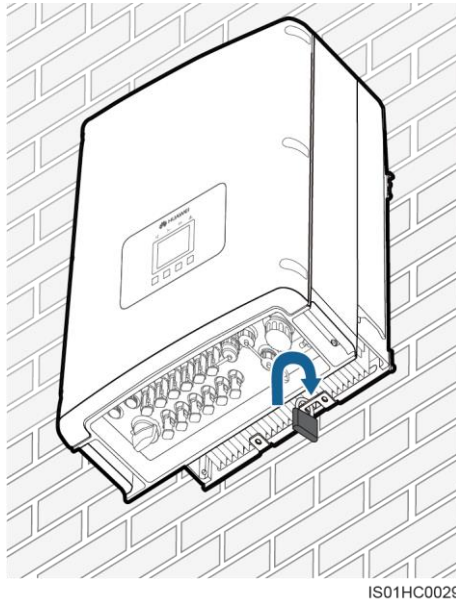
**Figure 4-25** Tightening hexagon screws



**Step 11** (Optional) Install an antitheft lock, as shown in [Figure 4-26](#).

The antitheft lock secures the SUN2000 to the rear panel to prevent theft.

**Figure 4-26** Installing an antitheft lock



----End

---

# 5 Electrical Connections

---

This topic describes the SUN2000 electrical connections. Read this part carefully before protection ground (PGND) cables, DC input power cables, AC output power cables, and communications cables for the SUN2000.

## Context



### **DANGER**

Before performing any electrical connection, ensure that the DC SWITCH is OFF. Otherwise, the high voltage can result in fatal injury.

---



### **NOTICE**

The cable colors shown in electrical connection schematic drawings are only for reference. Select cables according to local cable specifications (Yellow-green wires are only used for grounding).

---

## 5.1 Connecting PGND Cables

Connect the SUN2000 to a ground bar using a PGND cable for grounding purposes.

### Prerequisites

A PGND cable should be available. The PGND cable is recommended to be an outdoor copper-core cable with a cross-sectional area of 6 mm<sup>2</sup> or 10 AWG.



## Context

Good grounding for the SUN2000 helps resist the impact of surge voltage and improve EMI performance. Connect the PGND cable before connecting the AC power cables, DC power cables, and communications cables.

It is recommended that the ground cable be connected to a nearby ground position. For a system with multiple inverters connected in parallel, connect the ground points of all inverters to ensure equipotential connections.

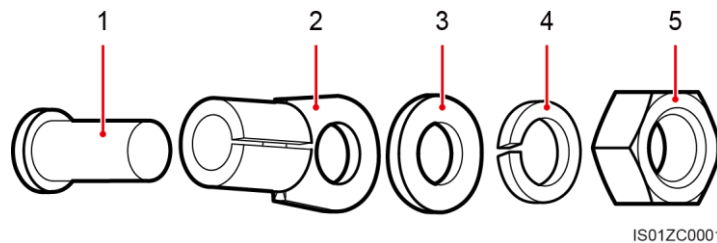


### NOTE

If the installation location is near the ground, connect the PGND cable to the ground before installing the SUN2000.

A ground terminal has five parts, as shown in [Figure 5-1](#).

**Figure 5-1** Ground terminal composition

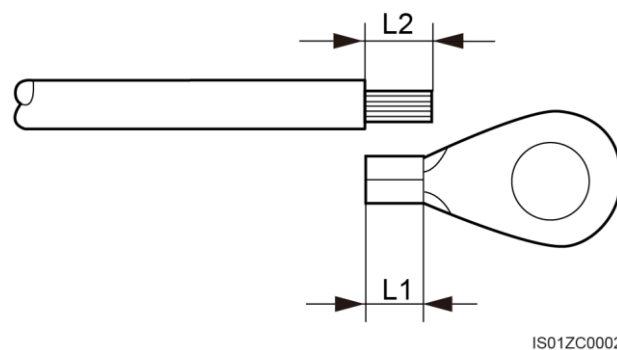


- (1) M6 welded stud    (2) OT terminal    (3) Flat washer    (4) Spring washer    (5) Nut

## Procedure

- Step 1** Remove an appropriate length of the insulation layer from the PGND cable using a wire stripper, as shown in [Figure 5-2](#).

**Figure 5-2** Stripped length

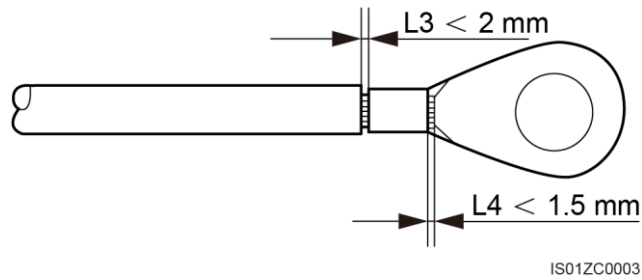


Note: L2 is 2 mm to 3 mm longer than L1.

- Step 2** Insert the exposed core wires into the conductor crimp area of the OT terminal and crimp them using a crimping tool, as shown in [Figure 5-3](#).

Recommended OT terminal: OT-6 mm<sup>2</sup> or 10 AWG-M6.

**Figure 5-3** Position of the crimp area

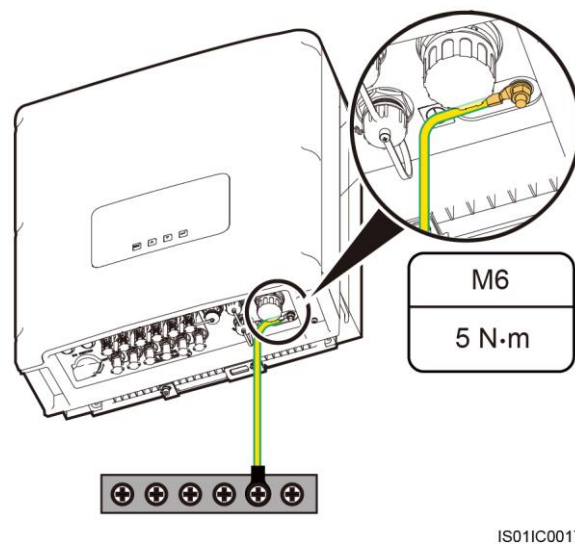


Note 1: L3 is the distance between the cable insulation layer and the conductor crimp area of the OT terminal. L4 is the length of the cable conductors protruding out of the crimp area.

Note 2: The crimping must result in full containment of the cable conductors and complete contact between the cable conductors and the terminal.

- Step 3** Install the crimped OT terminal, a flat washer, and a spring washer on the M6 welded stud in sequence, and tighten the nut to a torque of 5 N·m using a socket wrench, as shown in [Figure 5-4](#).

**Figure 5-4** Connecting the PGND cable to the SUN2000



**NOTE**

To prevent corrosion, apply silica gel to the ground terminal after connecting the PGND cable.

----End

## Follow-up Procedure

To disconnect the PGND cable, remove the nut from the M6 welded stud using an adjustable wrench, and then remove the spring washer, flat washer, and crimped OT terminal.

## 5.2 Connecting AC Output Power Cables

Connect the SUN2000 to the AC power distribution frame (PDF) or power grid using AC output power cables. Ensure that the cable connections meet the requirements of the local power grid operator.

### Prerequisites

A three-phase AC switch needs to be configured outside the AC side of the SUN2000. To ensure that the SUN2000 can safely disconnect from the power grid under abnormal conditions, select an appropriate overcurrent protection device according to local power distribution regulations.



### WARNING

- Do not install a single circuit breaker for several SUN2000s.
  - Do not connect loads between the SUN2000 and circuit breaker.
- 

### Context

Flexible cables are recommended for ease of installation. The outer diameter of the cable conductor should be less than or equal to 4.2 mm. [Table 5-1](#) lists the specifications.



### NOTE

If the PID module is used in a PV array containing the SUN2000, verify that the working voltage of AC cables to the ground is no less than 600 V AC, and that the voltage between AC cables is no less than 1000 V AC.

**Table 5-1** Recommended AC output power cable specifications

Inverter Model	Cable Type		Cross-sectional Area (mm <sup>2</sup> )		Cable Outer Diameter (mm)	
	Range	Recommended Value	Range	Recommended Value	Range	Recommended Value
SUN2000-8KTL	<ul style="list-style-type: none"> <li>4-core outdoor cable (3+N)</li> <li>5-core outdoor cable (3+N+PE)</li> </ul>	4-core outdoor cable (3+N)	4-10 (or 12 AWG-8 AWG)	4 (or 12 AWG)	11-20 <b>NOTE</b> <ul style="list-style-type: none"> <li>For a cable with an outer diameter of 11 mm to 13 mm, add cable clamps.</li> <li>For a cable with an outer diameter of 16 mm to 20 mm, strip a seal ring from inside the cable gland.</li> <li>For an armored cable with an outer diameter exceeding 20 mm, strip the jacket and armored layer and waterproof and ultraviolet-proof the cable.</li> </ul>	15
SUN2000-10KTL						
SUN2000-12KTL						
SUN2000-15KTL			6-10 (or 10 AWG-8 AWG)	6 (or 10 AWG)		
SUN2000-17KTL						
SUN2000-20KTL						
SUN2000-23KTL			<ul style="list-style-type: none"> <li>3-core outdoor cable</li> <li>4-core outdoor cable (3+PE)</li> </ul>	3-core outdoor cable		
SUN2000-28KTL						

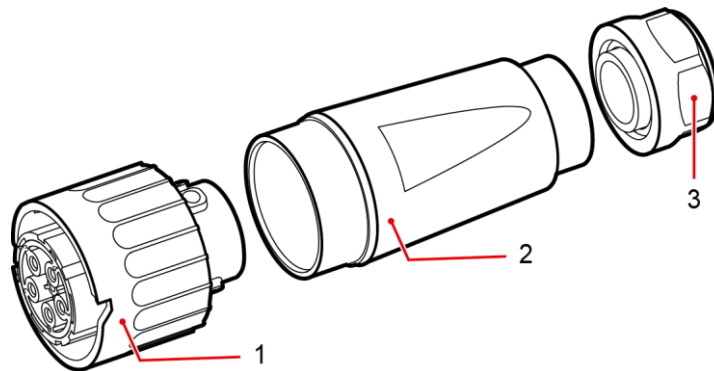


**NOTICE**

- If the PGND cable has already been installed according to [5.1 Connecting PGND Cables](#), there is no need to connect the PE wire of the AC output power cable.
- If a cable with a cross-sectional area of 4 mm<sup>2</sup> to 10 mm<sup>2</sup> is used, crimp a tubular cord end terminal at the cable end before installing the cable.

An AC output connector has three parts: coupler, adapter, and cable gland, as shown in [Figure 5-5](#).

**Figure 5-5** AC output connector



IS01ZC0004

(1) Coupler

(2) Adapter

(3) Cable gland

## Procedure

**Step 1** Remove the cable gland and adapter from the AC output connector.

**Step 2** Remove an appropriate length of the jacket and insulation layer of the core wires from the AC output cable using a wire stripper, as shown in [Figure 5-6](#).

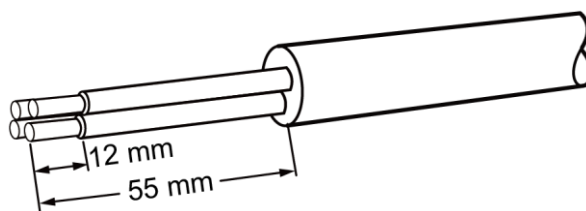


### NOTICE

The core wires (L1, L2, L3, and N) of the AC power cable must be correctly identified to prevent incorrect cable connections which can cause device damage or startup failure. (No neutral cable connections are involved for the SUN2000-28KTL.)

1. Strip the jacket of the AC output cable by 55 mm.
2. Strip the insulation layer of each core wire by 12 mm.

**Figure 5-6** Stripped length



IS01ZC0035



### NOTE

The preceding figure shows the stripped length only for all SUN2000 models except the SUN2000-28KTL. For the SUN2000-28KTL, align the neutral cable with the protective jacket and cut off the neutral cable.



### CAUTION

When cutting off the cable, take protective measures to prevent personal injury.

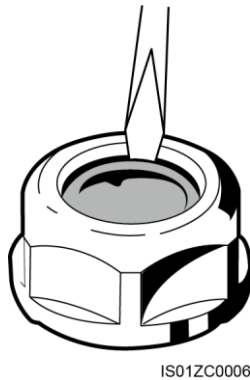
- Step 3** Insert the core wires (L1, L2, L3, and N) of the AC output cable into the cable gland and the adapter, as shown in [Figure 5-8](#).



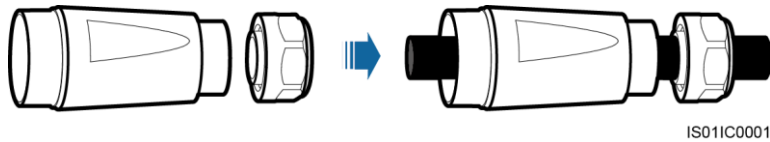
#### NOTE

If the outer diameter of the cable is greater than 16 mm, remove a seal ring from the interior of the cable gland (as shown in [Figure 5-7](#)) before inserting the power cable into the cable gland and the adapter.

**Figure 5-7** Stripping a seal ring

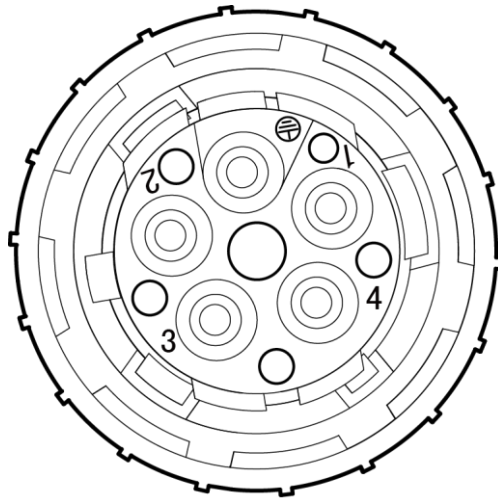


**Figure 5-8** Installing a cable gland and adapter



- Step 4** Loosen the screws of the coupler holes using a torque screwdriver. Insert the core wires into the corresponding holes as shown in [Figure 5-9](#). Tighten the screws to a torque of 0.7 N m, as shown in [Figure 5-10](#).

**Figure 5-9** Coupler

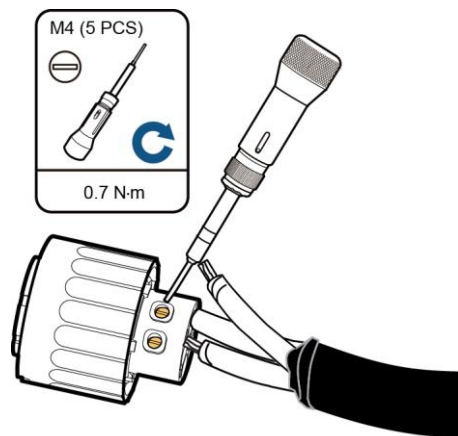


IS011C0002

- Connect L1 to hole number 1.
- Connect L2 to hole number 2.
- Connect L3 to hole number 3.
- Connect N to hole number 4.

For the SUN2000-28KTL, do not connect the neutral wire to hole number 4.

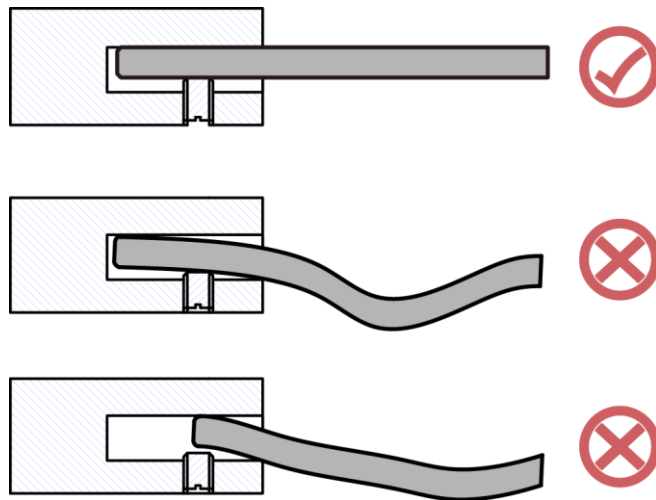
**Figure 5-10** Connecting an AC output cable to the coupler



IS011C0003

**Step 5** Check that all core wires are properly connected, as shown in [Figure 5-11](#).

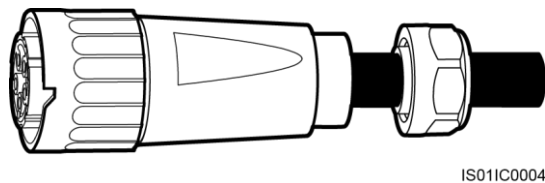
**Figure 5-11** Checking the cable connections



**Step 6** Secure the adapter to the coupler, as shown in [Figure 5-12](#).

Tighten the adapter to a torque of 1-2 N m.

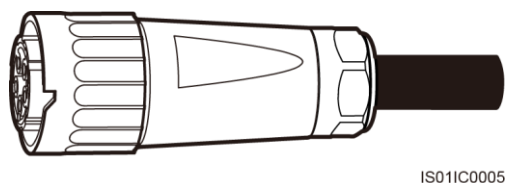
**Figure 5-12** Securing the adapter



**Step 7** Secure the cable gland to the adapter, as shown in [Figure 5-13](#).

Tighten the cable gland to a torque of 5 N m using a tool.

**Figure 5-13** Securing the cable gland

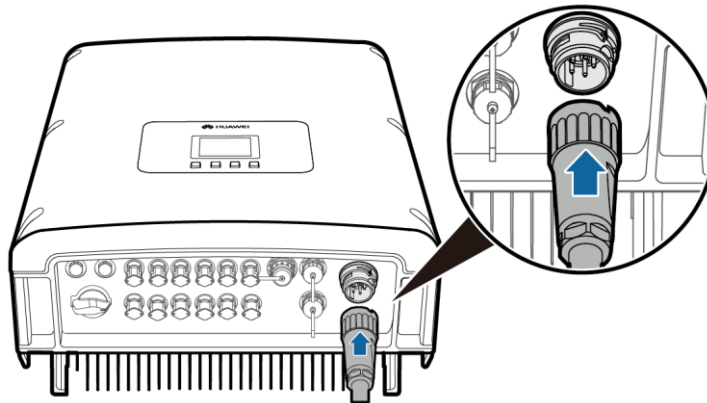


**Step 8** Connect the AC output connector to the bayonet coupling of the AC output wiring terminal on the SUN2000 and rotate it clockwise until a "click" sound is heard, as shown in [Figure 5-14](#).

Because there is insufficient space on the right of the AC terminal, tighten the terminal with the left hand.



**Figure 5-14** Connecting an AC output connector



IS011C0006



**NOTE**

The AC output connector is securely connected to the AC output wiring terminal after the bayonet coupling snaps into place.



**NOTICE**

Reserve a margin of more than 0.5 meter for the cable at the AC output power cable connector to reduce the cable terminal disconnection due to external force.

----End

## Follow-up Procedure

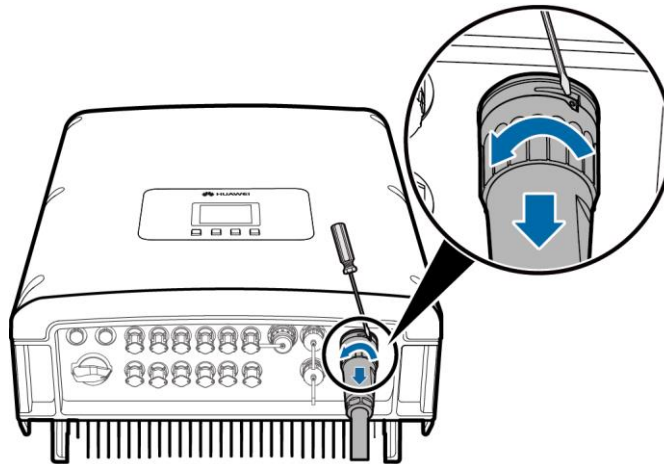
To remove the AC output connector from the SUN2000, press down the locking plate on the AC output wiring terminal using a flat-head screwdriver as shown in [Figure 5-15](#). Rotate the AC output connector counterclockwise.



**WARNING**

Before removing the AC output connector, switch off the circuit breaker between the SUN2000 and the power grid.

**Figure 5-15** Removing an AC output connector



IS011C0007

## 5.3 Connecting DC Input Power Cables

Connect the SUN2000 to PV strings using DC input power cables.

### Prerequisites



#### **DANGER**

- PV modules generate electric energy when exposed to sunlight and can create an electrical shock hazard. Therefore, when connecting DC input power cables, shield the PV modules with opaque cloth.
  - Before connecting DC input cables, ensure that the voltage on the DC side is under the safety limit (60 V DC) and that the DC SWITCH on the SUN2000 is OFF. Otherwise, high voltage may result in fatal injury.
- 



#### **WARNING**

Ensure that the following requirements are met to prevent fire accidents:

---

- PV modules connected in series in each PV string must be of the same specifications.
- The maximum open-circuit voltage of each PV string must be always lower than or equal to 1000 V DC.
- The maximum short-circuit current of each PV string must be always lower than or equal to 23 A.
- The positive and negative terminals of PV modules must be connected to the positive and negative DC input terminals of the SUN2000 respectively.



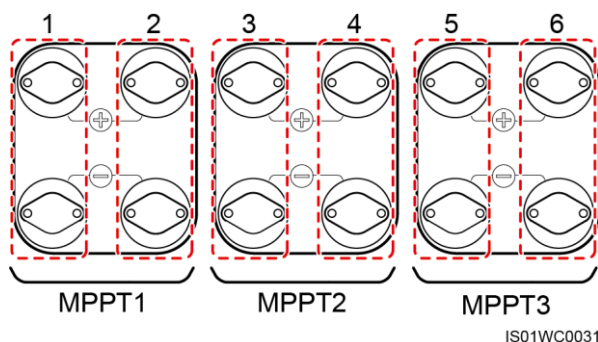
## NOTICE

- If the SUN2000 is directly connected to the power grid and no three-phase four-wire isolation transformer is connected to the output side, ensure that the PV strings are not grounded.
- If the DC voltage is a stable non-zero value between the positive terminal of a PV string and the ground, the PV string has an insulation fault. Rectify the fault before connecting cables.
- During PV string and SUN2000 installation, the positive or negative terminals of PV strings may be grounded if power cables are not properly installed or routed. In this case, an AC or DC short circuit may occur and damage the SUN2000.
- If the PV strings need to be grounded, install a three-phase four-wire isolation transformer on the output side and set the parameter of **Isolation** to **Input Grounded, With TF** by following the instructions in [7.2.11 Setting Isolation Parameters](#). If no isolation transformer is connected, the SUN2000 will not operate properly.

## Context

Figure 5-16 shows the MPPT distribution of the SUN2000.

Figure 5-16 MPPT distribution



- The SUN2000-8KTL to SUN2000-12KTL provide two MPPT routes to track the maximum power point for PV strings. Therefore, two to four DC inputs should be evenly distributed on two terminal groups.
- The SUN2000-15KTL to SUN2000-28KTL provide three MPPT routes to track the maximum power point for PV strings. Therefore, two to six DC inputs should be evenly distributed on three terminal groups.

Table 5-2 describes the recommended DC input cable specifications.

**Table 5-2** Recommended DC input cable specifications

Cable Type	Cross-sectional Area (mm <sup>2</sup> )		Cable Outer Diameter (mm)
	Range	Recommended Value	
Common PV cable	4-6	4	4.5-7.8

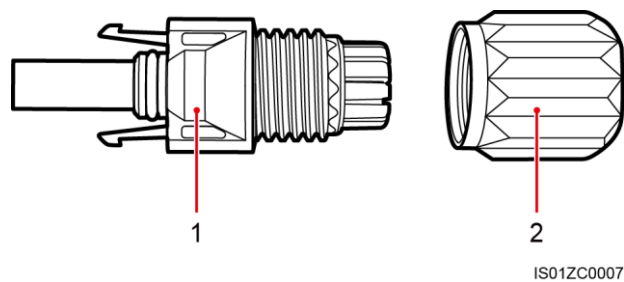


**NOTICE**

Highly rigid cables, such as armored cables, are not recommended because bending may cause poor contact.

The positive and negative DC input connectors are used, as shown in Figure 5-17 and Figure 5-18.

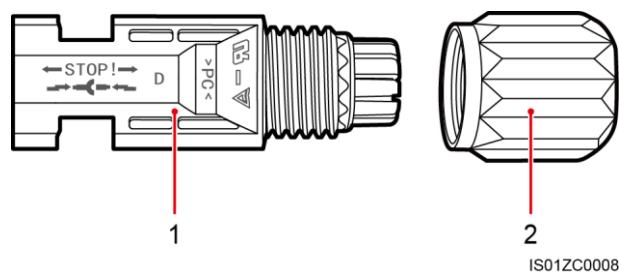
**Figure 5-17** Positive connector composition



(1) Insulation housing

(2) Locking nut

**Figure 5-18** Negative connector composition



(1) Insulation housing

(2) Locking nut



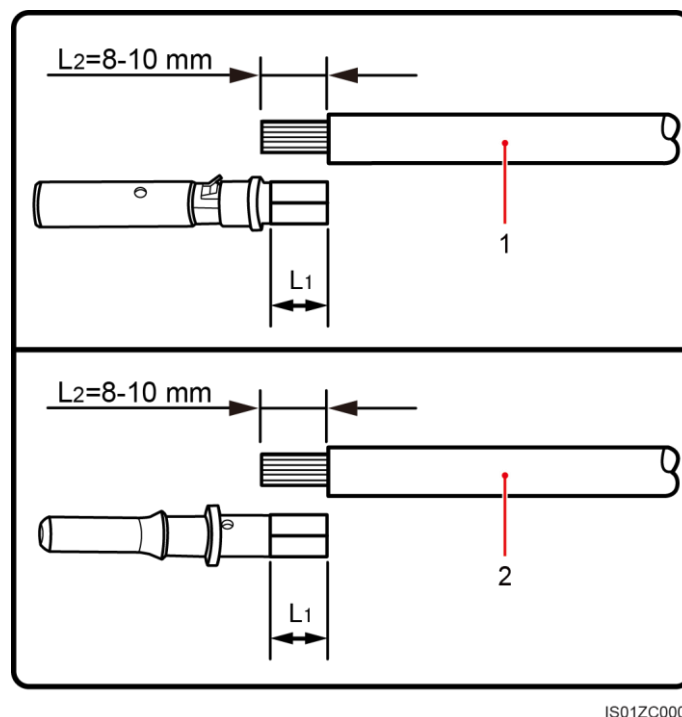
## NOTICE

Positive and negative metal terminals are packed with positive and negative connectors respectively. After unpacking, keep the positive and negative ones separate to avoid confusion.

## Procedure

- Step 1** Unscrew the locking nuts from the positive and negative connectors.
- Step 2** Remove an appropriate length of the insulation layer from the positive and negative power cables using a wire stripper, as shown in [Figure 5-19](#).

**Figure 5-19** Stripped length

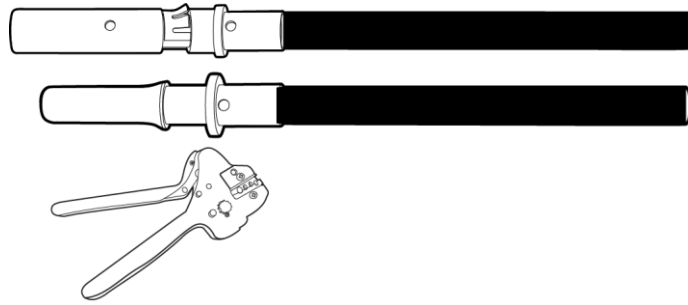


(1) Positive power cable

(2) Negative power cable

- Step 3** Insert the exposed area of the positive and negative power cables into the metal terminals of the positive and negative connectors respectively and crimp them using a crimping tool, as shown in [Figure 5-20](#). Ensure that the cables are crimped tightly such that they cannot be pulled out by a force less than 400 N.

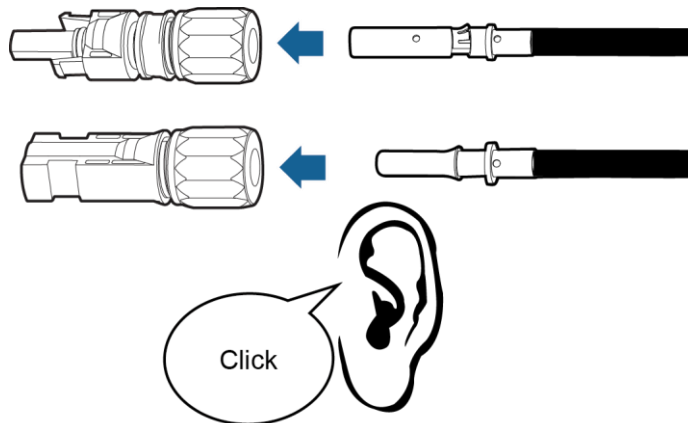
**Figure 5-20** Crimping a metal terminal



IS01ZC0017

**Step 4** Insert the crimped positive and negative power cables into the corresponding insulation housings until they snap into place, as shown in [Figure 5-21](#).

**Figure 5-21** Engaging metal terminals



IS01ZC0018



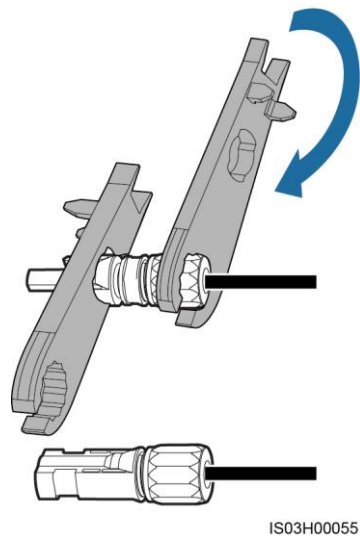
### NOTICE

After inserting the crimped areas of the positive and negative power cables into the corresponding insulation housings, ensure that the cables are in position by checking for resistance when a slight pull is applied.

**Step 5** Reinstall cable glands on positive and negative connectors and rotate them against the insulation covers.

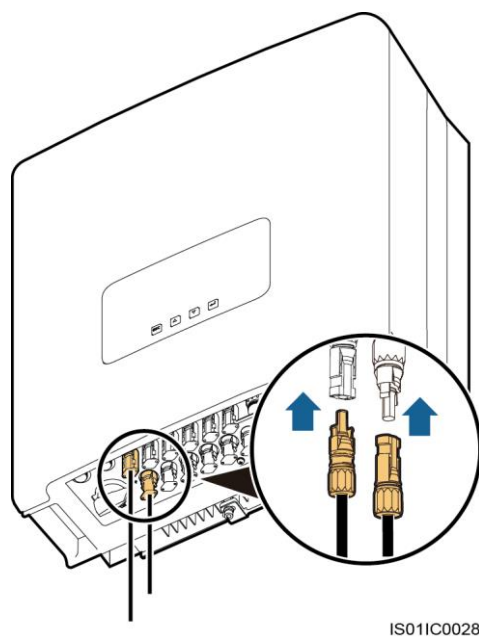
It is recommended that you secure the nut by using removal wrenches, as shown in [Figure 5-22](#).

**Figure 5-22** Locking a nut



- Step 6** Take off the blue dustproof plugs from the bottom of the DC input connectors.
- Step 7** Insert the positive and negative connectors into the corresponding DC input terminals of the SUN2000 until a "click" sound is heard, as shown in [Figure 5-23](#).

**Figure 5-23** Positive and negative connectors





## NOTICE

- After the positive and negative connectors are in position, the space between the DC terminals and connectors should be less than or equal to 0.8 mm.
- Reserve a margin of more than 0.5 meter for the cable at the DC input power cable connector to reduce the cable terminal disconnection due to external force.

----End

## Follow-up Procedure

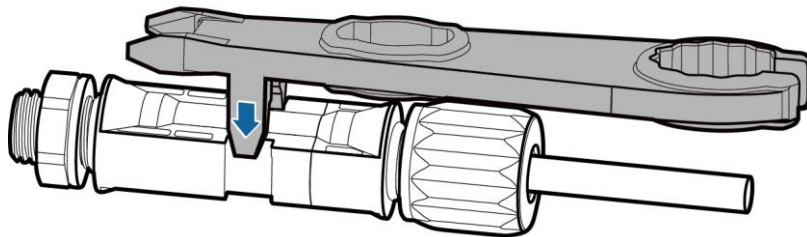
To remove the positive and negative connectors from the SUN2000, insert a removal wrench into the bayonet lock and apply an appropriate force, as shown in [Figure 5-24](#).



## WARNING

Before removing the positive and negative connectors, ensure that the DC SWITCH is OFF.

**Figure 5-24** Removing a DC input connector



IS011C0042

## 5.4 Connecting Communications Cables

This section describes the functions of USB and RS485 ports and the method of connecting RS485 communications cables.

### 5.4.1 Communications Ports

This section describes the functions of the USB and RS485 ports.

#### Overview

The SUN2000 provides three communications ports: USB port, RS485 IN port, and RS485 OUT port, which are on the left, upper right, and lower right respectively. For details, see [Bottom View](#) in [2.2 Appearance](#).



## USB Port

- The SUN2000 communicates with a USB flash drive through the USB port to upgrade firmware, download and load configurations, and download data.
- The SUN2000 can communicate with the SUN2000 app over a Bluetooth module or USB data cable connected to the USB port, so that you can view the operating information and set parameters over the app.



### NOTE

- The SUN2000 app (Android) can communicate with the SUN2000 over a Bluetooth module or USB data cable, whereas the SUN2000 app (iOS) supports the communication with the SUN2000 only over a Bluetooth module. For details about version mappings and the operations on the SUN2000 app, see the *SUN2000 APP User Manual*.
- Use the USB port only during maintenance (such as power-on setting, upgrade, and data export). Ensure that the USB cover is tightened when the USB port is not in use.

## RS485 Ports

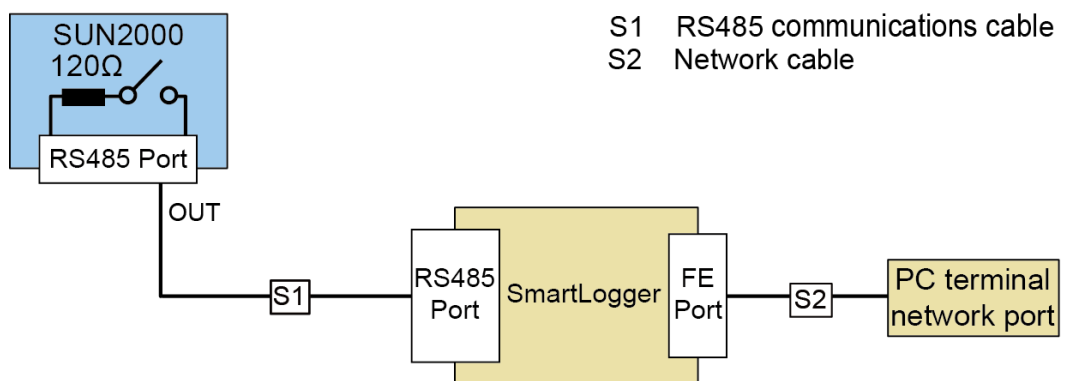
The SUN2000 sends alarm information, operating status, and data such as energy yield to a PC that runs network management software such as the NetEco or a local data collection and display device such as the SmartLogger through an RS485 port.

RS485 communication is implemented by connecting the SUN2000 according to the following guidelines:

- If only one SUN2000 is used, connect a communications cable with waterproof RJ45 connectors to either of the two RS485 ports and block the other one with a waterproof cover.
- If multiple SUN2000s are used, connect all SUN2000s in daisy chain mode over the RS485 communications cable.
- Connect the SUN2000 to the SmartLogger to implement data collection and monitoring, or connect it to the PC over the SmartLogger to implement communication.

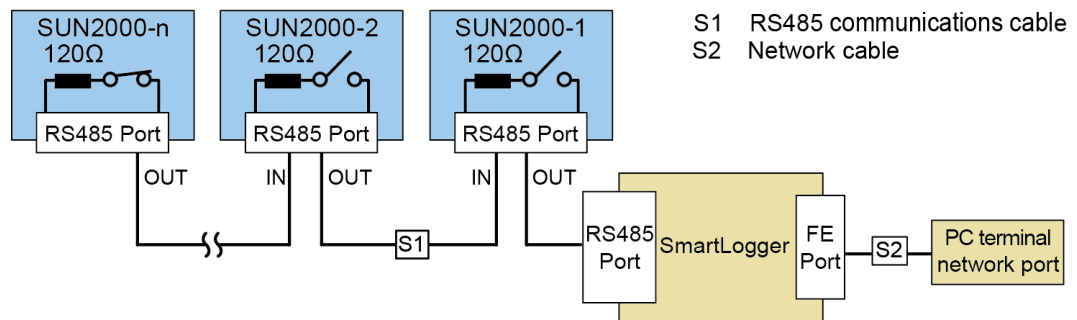
Figure 5-25 shows how one SUN2000 connects to the SmartLogger and the PC. Figure 5-26 shows how multiple SUN2000s connect to the SmartLogger and the PC.

Figure 5-25 Communication mode for a single SUN2000



IS01NC001

**Figure 5-26** Communication mode for multiple SUN2000s



IS01NC0002

**NOTE**

- For the SUN2000 on the end of the chain, on the **Comm. Param.** screen of the LCD, set **Match Resistance** to **Connect** (**Disconnect** by default) to enable the build-out resistor (see [7.2.8 Setting Communications Parameters](#) for details).
- **Match Resistance** can also be set using the SUN2000 APP. For details, see the *SUN2000 APP User Manual*. If the SUN2000 APP needs to be used for setting, ensure that the SUN2000 firmware version is V100R001C81SPC101 or later.
- The communications cable should be shorter than 1000 m.
- If multiple SUN2000s need to communicate with one another and are connected to a PC over the SmartLogger, a maximum of three daisy chains can be configured to support up to 80 devices. It is recommended that the number of devices on each daisy chain be less than 30.

## 5.4.2 Connecting RS485 Communications Cables

Connect the SUN2000 to communications equipment (such as the data collector and PC) using RS485 communications cables.

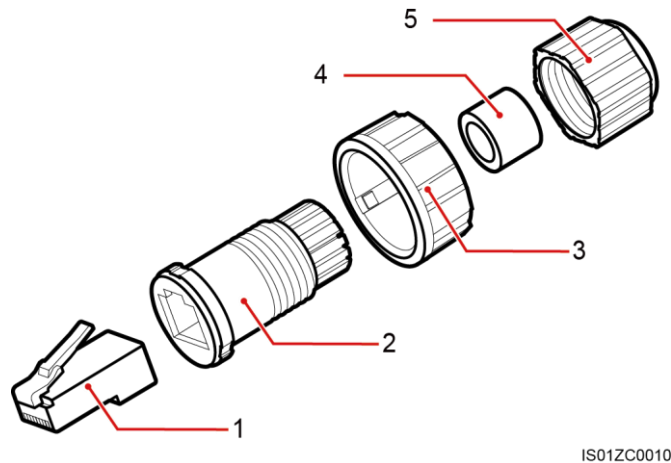
### Context

A 24 AWG outdoor shielded network cable with the following specifications is recommended for use as an RS485 communications cable:

- With an internal resistance less than or equal to 1.5 ohms/10 m
- With an outer diameter of 4.5-7.5 mm (8 core wires, each with a diameter of 1.00-1.07 mm)

A waterproof RJ45 connector has five parts: shielded plug, plastic housing, coupling nut, seal ring, and sealing nut. See [Figure 5-27](#).

**Figure 5-27** Waterproof RJ45 connector composition



IS012C0010

- |                   |                     |                  |
|-------------------|---------------------|------------------|
| (1) Shielded plug | (2) Plastic housing | (3) Coupling nut |
| (4) Seal ring     | (5) Sealing nut     |                  |



### NOTICE

When routing communications cables, ensure that they are separated from power cables and away from interference sources to prevent communication interruptions.

## Procedure

- Step 1** Remove an appropriate length of the insulation layer from the shielded network cable using a wire stripper.
- Step 2** Insert the shielded network cable through the sealing nut, seal ring, coupling nut, and plastic housing.
- Step 3** Line up the exposed wires of the network cable in sequence and connect them to the corresponding pins on the plug, as shown in [Figure 5-29](#).

**Figure 5-28** Connection sequence

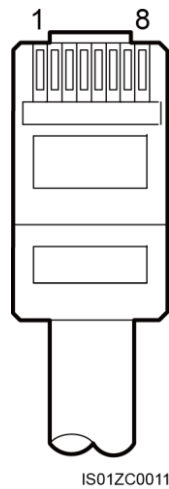
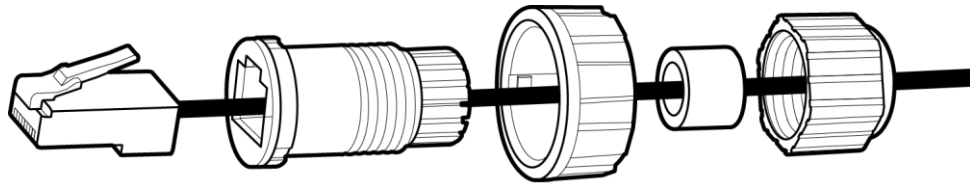


Figure 5-28 shows the connector side that does not have a clip. Table 5-3 lists the mapping between the pins and wires.

**Table 5-3** Mapping between pins and wires

Pin No.	Color	Function
1	White-orange	RS485A, RS485 differential signal +
2	Orange	RS485B, RS485 differential signal -
3	White-green	PGND
4	Blue	RS485A, RS485 differential signal +
5	White-blue	RS485B, RS485 differential signal -
6	Green	PGND
7	White-brown	PGND
8	Brown	PGND

**Figure 5-29** Connecting the plug

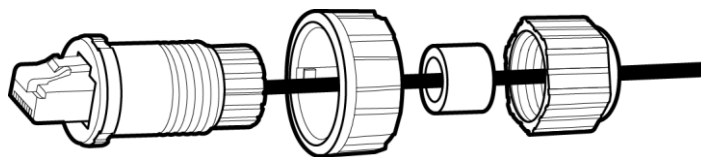


IS01IC0011

**Step 4** Crimp the plug using a crimping tool.

**Step 5** Secure the plastic housing to the plug, as shown in [Figure 5-30](#).

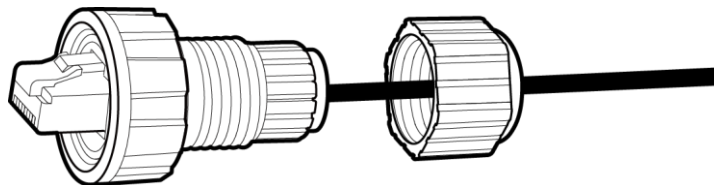
**Figure 5-30** Connecting the plastic housing



IS01IC0012

**Step 6** Insert the seal ring into the plastic housing and secure the coupling nut to the plastic housing, as shown in [Figure 5-31](#).

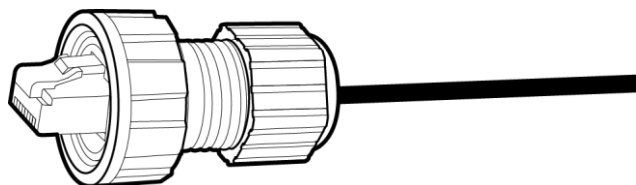
**Figure 5-31** Connecting the seal ring and coupling nut



IS01IC0013

**Step 7** Secure the sealing nut to the plastic housing, as shown in [Figure 5-32](#).

**Figure 5-32** Connecting the sealing nut



IS01IC0014

**Step 8** Insert the plug into the RS485 port on the SUN2000, and tighten the coupling nut.

----End

## Follow-up Procedure

To remove the waterproof RJ45 connector from the SUN2000, remove the coupling nut, press the clip on the RJ45 connector, and pull out the RJ45 connector.

---

# 6 System Operation

---

This chapter describes the SUN2000 power-on and initialization process.

## 6.1 Checking Before Power-On

To ensure normal SUN2000 operation, check the SUN2000 before powering it on.

Before powering on the SUN2000, check that:

1. The SUN2000 is installed correctly and securely.
2. The PGND cable is securely connected.
3. All AC output power cables are securely connected.
4. All DC input power cables are securely connected.
5. Idle DC input terminals are protected with sealing caps.
6. Idle USB and RS485 ports are blocked with waterproof plugs.

## 6.2 Powering On the SUN2000

Power on the SUN2000 after electrical connections are completed.

### Procedure

- Step 1** Switch on the AC circuit breaker between the SUN2000 and the power grid.



### NOTICE

If [Step 2](#) is performed before [Step 1](#), the SUN2000 reports a fault about abnormal shutdown on the LCD. Start the SUN2000 only after the fault is automatically rectified. This takes a default clearance time of 1 minute. The clearance time can be modified using LCD or the network management software running on a PC connected to the SUN2000.



### NOTE

The monitoring panel is activated only after power is supplied to the DC or AC side.

- Step 2** Set the DC SWITCH at the bottom of the SUN2000 to **ON**.
- Step 3** (Optional) Measure the temperatures at the joints between the DC terminals and the connectors using a point thermometer.
- End

## 6.3 Setting Initialization Parameters

When starting the SUN2000 for the first time, set initialization parameters such as the system language, system time, and power grid code on the monitoring panel.

### Context

If the SUN2000 is started for the first time, follow the instructions to set the initialization parameters. If the SUN2000 is not started for the first time, the startup detection screen is displayed.



### NOTICE










Before setting initialization parameters, ensure that the power-on operation in [6.2 Powering On the SUN2000](#) has been completed.

### Procedure

- The following table lists the procedure for setting initialization parameters. The parameter values in the figures are for reference only.

LCD Screen	Procedure
	<p>1. Start with the initialization screen displayed while the system is loading.</p> <p>The default system language is <b>English</b>.</p>
	<p>2. Press <b>←</b> to enter the <b>Wizard</b> screen.</p> <p>To return to the default screen, press <b>ESC</b>. To reset initialization parameters, choose <b>Settings &gt; Wizard</b> as <b>Advanced User</b>.</p>



LCD Screen	Procedure
<pre> Initialization-&gt;Wizard   Language   English   中文   Deutsch   Italiano   Français   Polski                     </pre>	<p>3. Select a display language and press .</p> <p>The screens will be displayed in the selected language.</p>
<pre> Initialization-&gt;Wizard   Date&amp;Time   Date:2013-06-17   Time:09:42:17                     </pre>	<p>4. Set the date and time and press .</p> <ul style="list-style-type: none"> <li>To select a parameter, press . To set the parameter value, press  or .</li> <li>The date format is <b>YYYY-MM-DD</b>. <b>YYYY</b>, <b>MM</b>, and <b>DD</b> stand for year, month, and day respectively. The time format is <b>hh-mm-ss</b>. <b>hh</b>, <b>mm</b>, and <b>ss</b> stand for hour, minute, and second respectively.</li> </ul>
<pre> Wizard-&gt;Grid Code   Grid Code   VDE-AR-N-4105   NB/T 32004   UTE C 15-712-1(A)   UTE C 15-712-1(B)   UTE C 15-712-1(C)   VDE 0126-1-1-BU                     </pre>	<p>5. Set the power grid code and press .</p> <p>To select a power grid code, click  or .</p> <p><b>NOTICE</b> Incorrectly setting <b>Grid Code</b> will cause a SUN2000 startup failure.</p> <p><b>NOTE</b></p> <ul style="list-style-type: none"> <li>For details about power grid codes, see <a href="#">B Power Grid Codes</a>. Select an appropriate power grid code based on the requirements of the country or region.</li> <li>When the sunlight is insufficient, the grid code cannot be successfully set. Wait until the sunlight becomes sufficient, log in to the system as <b>Advanced User</b>, and choose <b>Settings &gt; Wizard</b> to set the grid code.</li> <li>The SUN2000-28KTL applies only to the medium-voltage grid connection scenarios, and supports only the Chinese, German, and customized medium-voltage grid codes.</li> </ul>
<pre> Initialization-&gt;Wizard   Finished   Language:English   Time:2013-06-17 00:38:06   Grid Code:VDE-AR-N4105   ↓:Confirm                     </pre>	<p>6. On the <b>Finished</b> screen, press .</p>



## NOTICE

After the initialization parameters are set for multiple SUN2000s in the same network, set the address and baud rate for each SUN2000 based on the following rules:

- Every SUN2000 in the same daisy chain must have a unique address. If communication with the SmartLogger is required, every SUN2000 in the daisy chain must have a unique address within the address scope configured for the SmartLogger.
- All SUN2000s in the same daisy chain must have the same baud rate. If communication with the SmartLogger is required, all SUN2000s in the daisy chain must have the same baud rate configured for the SmartLogger.

---

----End

# 7 Man-Machine Interaction

---

## Context

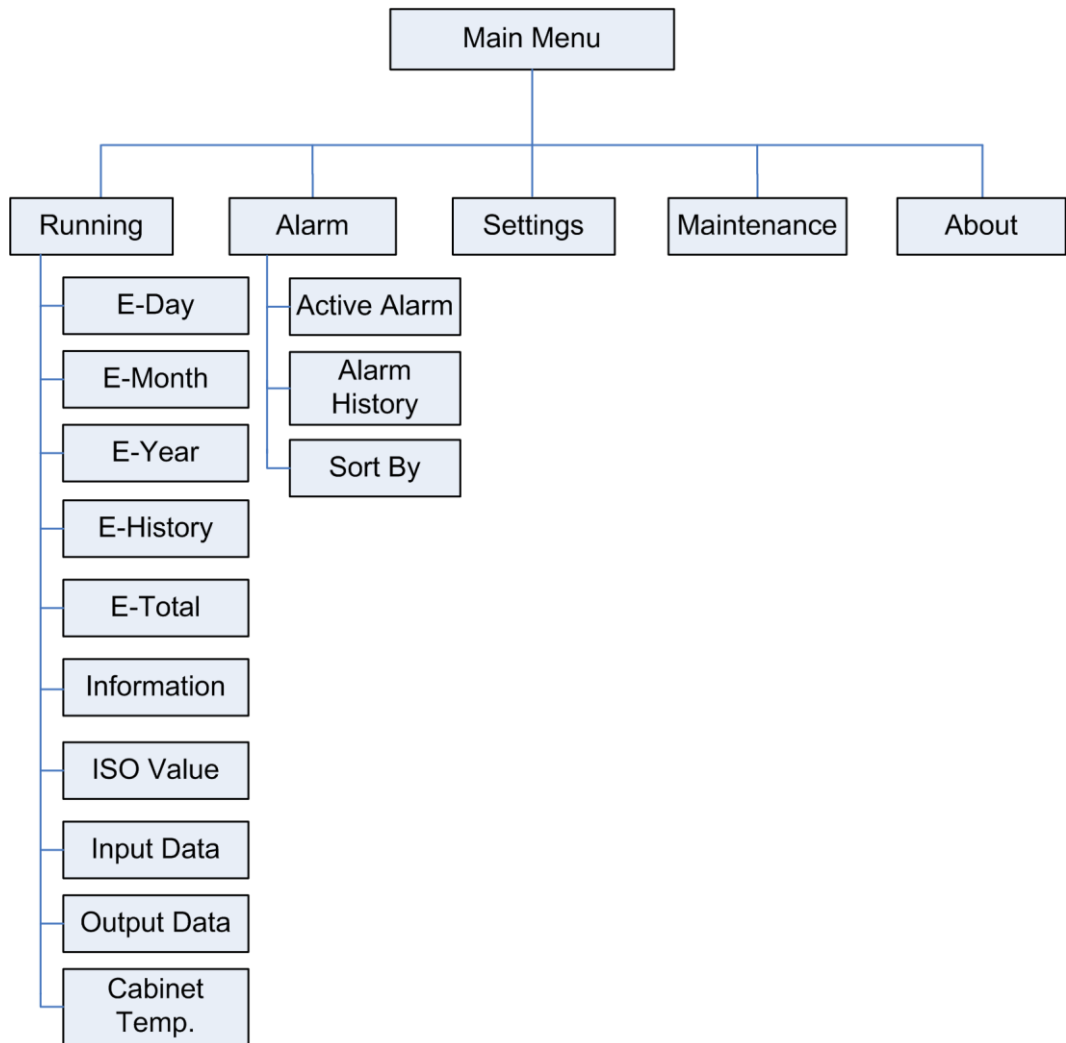
Users can interact with the SUN2000 using the LCD or SUN2000 APP. This topic uses operations on the LCD as an example. For details about operations on the SUN2000 APP, see the *SUN2000 APP User Manual*.

## 7.1 Monitoring Menu Hierarchy

This section describes the hierarchy of the monitoring menus on the LCD, which facilitates monitoring of the SUN2000.

[Figure 7-1](#) shows the hierarchy of the **Main Menu**.

**Figure 7-1** Hierarchy of the Main Menu



IS01CC0001

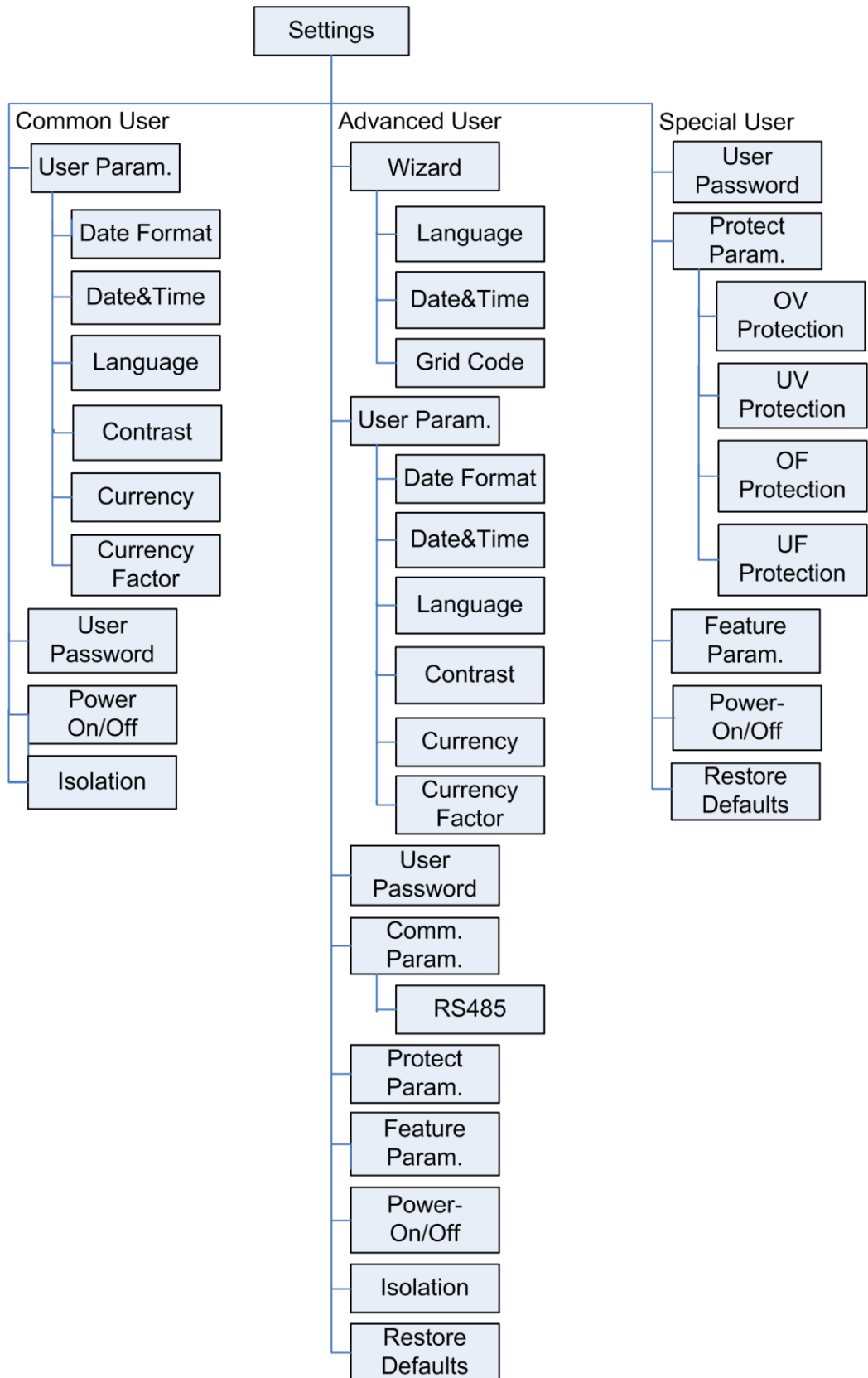
The parameters vary with user types. The three types of user are **Common User**, **Advanced User**, and **Special User**. [Figure 7-2](#) and [Figure 7-3](#) show the hierarchies under the **Settings** and **Maintenance** menus.



## NOTICE

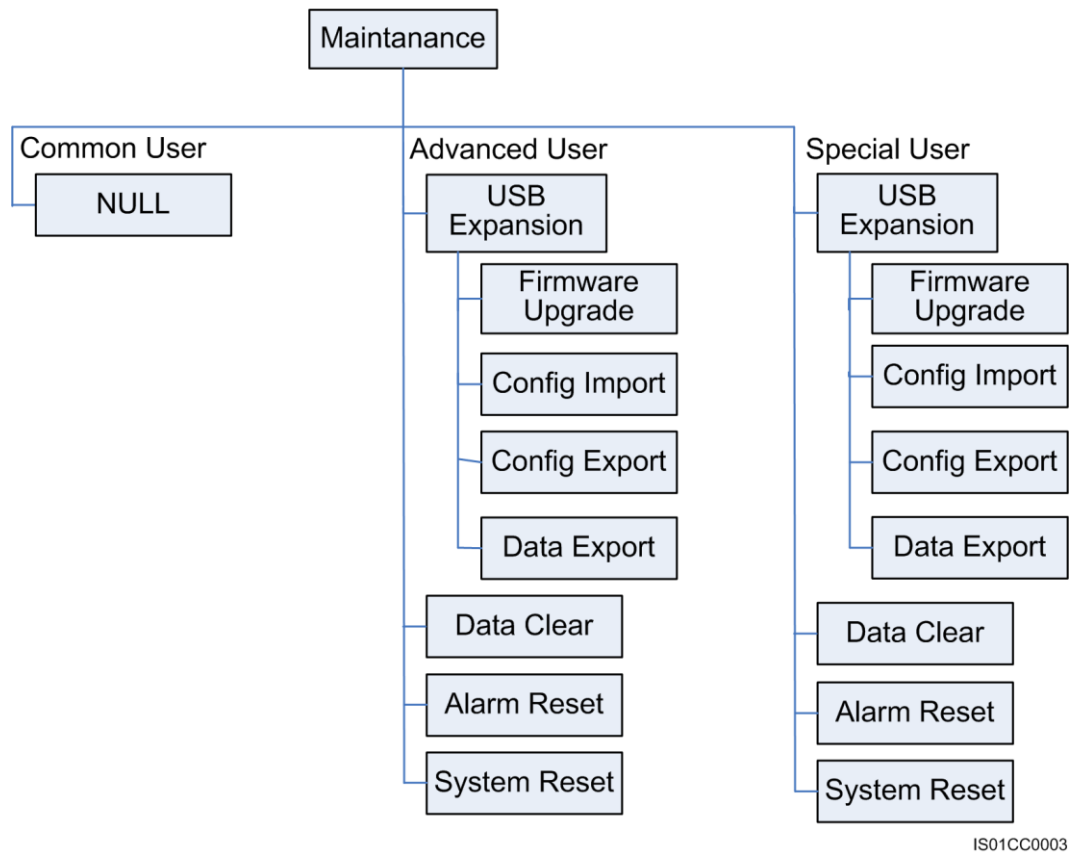
The initial password for **Common User**, **Advanced User**, and **Special User** is *000001*. Use the initial password to log in to the SUN2000 for the first time and change the password immediately (see [7.2.7 Changing a User Password](#)) to ensure account safety.

Figure 7-2 Hierarchy of the Settings menu



IS01CC0002

Figure 7-3 Hierarchy of the Maintenance menu



 **NOTE**

Due to permission restrictions, the submenus under **Maintenance** will not appear when a user logs in as a **Common User**.

## 7.2 Monitoring Operations

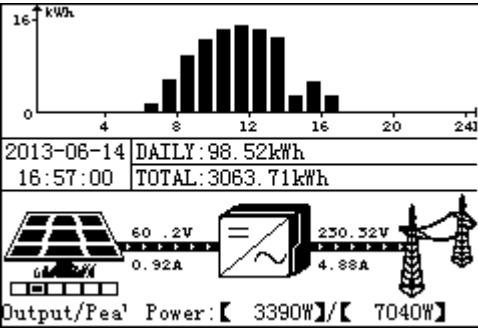

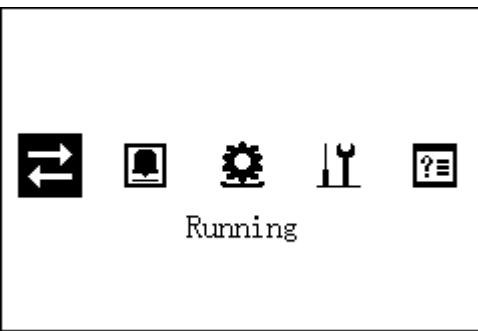


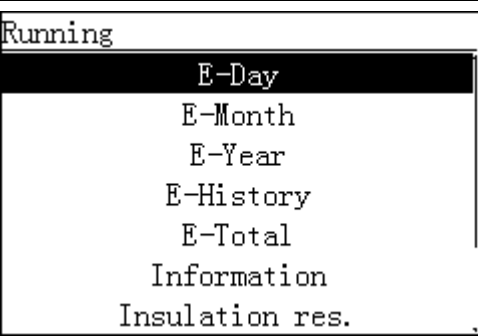


This section describes how to perform monitoring operations, such as viewing system operating information and setting user parameters, on the monitoring panel.

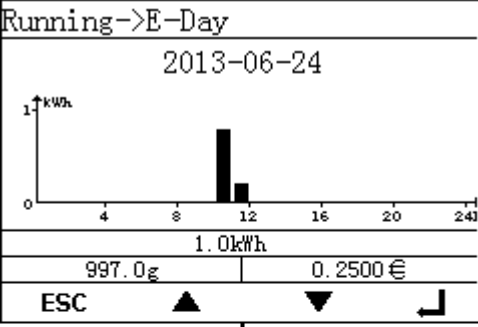
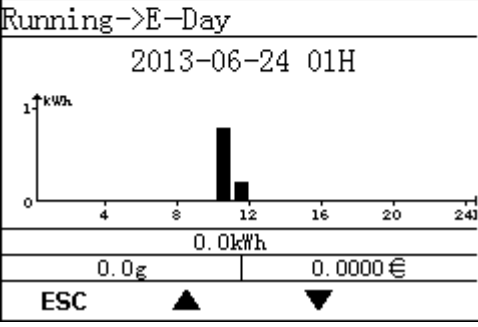
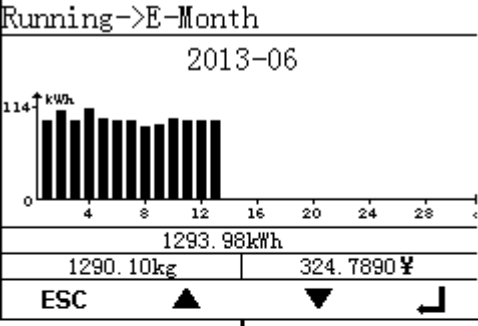
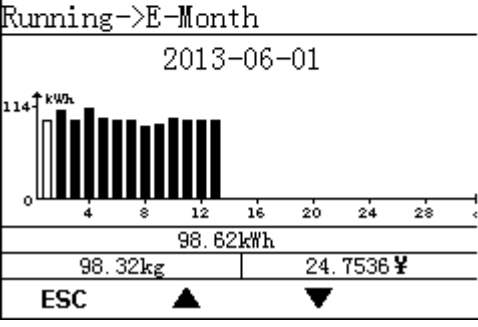
### 7.2.1 Viewing System Operating Information

The SUN2000 operating information can be viewed on the monitoring panel. The operating information includes the daily, monthly, yearly, historical, and total energy yields, insulation resistance, input data, output data, and internal temperature.

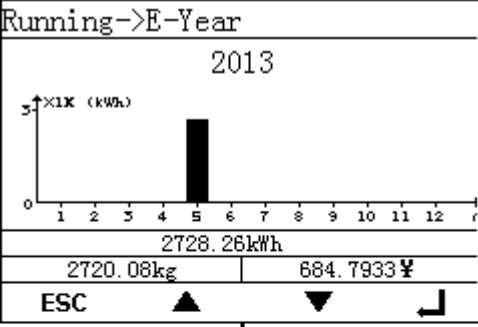
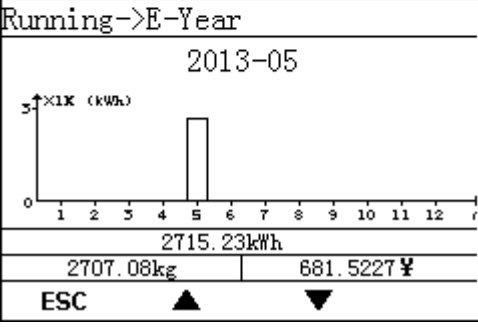
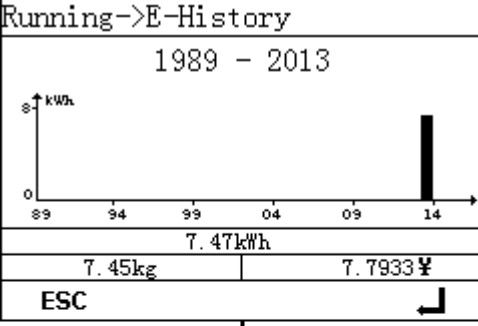
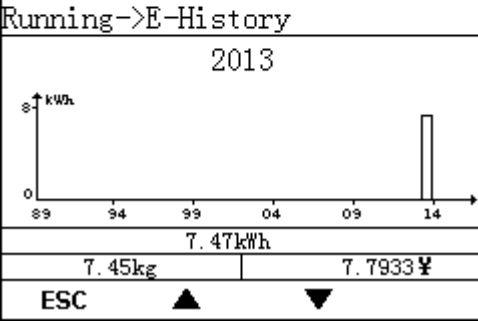
#### Procedure

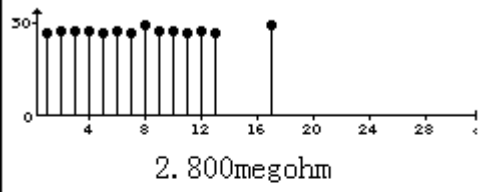
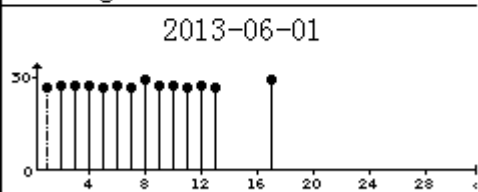
- The following table lists the procedure for viewing system operating information. The parameter values in the figures are for reference only.

LCD	Procedure
 <p>2013-06-14 16:57:00 DAILY: 98.52kWh TOTAL: 3063.71kWh</p> <p>60.2V 0.92A 250.32V 4.88A Output/Peak Power: 【 3390W】/【 7040W】</p>	<p>1. On the default screen, press  to enter the main menu.</p>
 <p>Running</p>	<p>2. Choose  and press .</p>
 <p>Running</p> <p>E-Day E-Month E-Year E-History E-Total Information Insulation res.</p>	<p>3. Select an operating parameter by pressing  and press .</p>

LCD	Procedure
<p>Running-&gt;E-Day</p>  <p>2013-06-24</p> <p>1.0kWh</p> <p>997.0g      0.2500€</p> <p>ESC ▲ ▼ ↵</p> <p>Running-&gt;E-Day</p>  <p>2013-06-24 01H</p> <p>0.0kWh</p> <p>0.0g      0.0000€</p> <p>ESC ▲ ▼ ↵</p>	<p>4. View the daily energy yield.</p> <p>a. On the <b>E-Day</b> screen, view the total energy yield and hourly energy yield for the current day. The displayed information includes the daily energy yield histogram, date, total energy yield of the current day, CO<sub>2</sub> emission reduction, and revenue from the energy yield.</p> <p><b>NOTE</b></p> <p>In the daily energy yield histogram, the time is represented by the horizontal axis in one-hour intervals. The energy yield is represented by the vertical axis. Each bar represents the total energy yield for that hour.</p> <p><b>NOTICE</b></p> <p>To view the energy yield in the past 30 days (including the current day), press ▲ or ▼. To view the hourly energy yield on a specific day, press ↵.</p> <p>b. Press ↵ to view the energy yield of a specific hour on the current day. To switch between hours, press ▲ or ▼.</p> <p><b>NOTE</b></p> <p>The selected block is displayed in white.</p>
<p>Running-&gt;E-Month</p>  <p>2013-06</p> <p>1293.98kWh</p> <p>1290.10kg      324.7890¥</p> <p>ESC ▲ ▼ ↵</p> <p>Running-&gt;E-Month</p>  <p>2013-06-01</p> <p>98.62kWh</p> <p>98.32kg      24.7536¥</p> <p>ESC ▲ ▼ ↵</p>	<p>5. View the monthly energy yield.</p> <p>a. On the <b>E-Month</b> screen, view the total energy yield and daily energy yield in the current month. The displayed information includes the monthly energy yield histogram, date, total energy yield of the current month, CO<sub>2</sub> emission reduction, and revenue from the energy yield.</p> <p><b>NOTE</b></p> <p>In the monthly energy yield histogram, the month is represented by the horizontal axis in one-day intervals. The energy yield is represented by the vertical axis. Each bar represents the total energy yield for that day.</p> <p><b>NOTICE</b></p> <p>To view the energy yield in the past 12 months (including the current month), press ▲ or ▼. To view the daily energy yield in a specific month, press ↵.</p> <p>b. Press ↵ to view the energy yield on a specific day of the current month. To switch between days, press ▲ or ▼.</p> <p><b>NOTE</b></p> <p>The selected block is displayed in white.</p>



LCD	Procedure
<p>Running-&gt;E-Year</p>  <p>2013</p> <p>2728.26kWh</p> <p>2720.08kg   684.7933¥</p> <p>ESC ▲ ▼ ↵</p> <p>Running-&gt;E-Year</p>  <p>2013-05</p> <p>2715.23kWh</p> <p>2707.08kg   681.5227¥</p> <p>ESC ▲ ▼ ↵</p>	<p>6. View the yearly energy yield.</p> <p>a. On the <b>E-Year</b> screen, view the total energy yield and monthly energy yield in the current year. The displayed information includes the yearly energy yield histogram, date, total energy yield of the current year, CO<sub>2</sub> emission reduction, and revenue from the energy yield.</p> <p><b>NOTE</b></p> <p>In the yearly energy yield histogram, the year is represented by the horizontal axis in one-month intervals. The energy yield is represented by the vertical axis. Each bar represents the total energy yield for that month.</p> <p><b>NOTICE</b></p> <p>To view the energy yield in the past 25 years (including the current year), press ▲ or ▼. To view the monthly energy yield in a specific year, press ↵.</p> <p>b. Press ↵ to view the energy yield in a specific month of the current year. To switch between months, press ▲ or ▼.</p> <p><b>NOTE</b></p> <p>The selected block is displayed in white.</p>
<p>Running-&gt;E-History</p>  <p>1989 - 2013</p> <p>7.47kWh</p> <p>7.45kg   7.7933¥</p> <p>ESC ↵</p> <p>Running-&gt;E-History</p>  <p>2013</p> <p>7.47kWh</p> <p>7.45kg   7.7933¥</p> <p>ESC ▲ ▼ ↵</p>	<p>7. On the <b>E-History</b> screen, view the historical energy yield. The LCD displays the yearly energy yield histogram, time periods, total energy yield of the selected year, CO<sub>2</sub> emission reduction, and revenue from the energy yield. Data of the past 25 years (current year included) are available.</p> <p><b>NOTE</b></p> <p>In the yearly energy yield histogram, the year is represented on the horizontal axis. The energy yield is represented by the vertical axis. Each bar represents the total energy yield for that year.</p> <p>Press ↵, then press ▲ or ▼ to view the energy yield of the selected year.</p>

LCD	Procedure
<p>Running-&gt;E-Total</p> <p>E-Total:2993.36kWh CO<sub>2</sub> Reduction:2984.38kg Gain:751.3334¥</p>	<p>8. On the <b>E-Total</b> screen, view the total energy yield, CO<sub>2</sub> emission reduction, and revenue.</p>
<p>Information</p> <p>Address:1 Version:V100R001C81SPC103 Name:</p>	<p>9. On the <b>Information</b> screen, view the address, firmware version, and device name.</p>
<p>Running-&gt;ISO Value</p> <p>2013-06</p>  <p>2.800megohm</p> <p>ESC ▲ ▼ ↵</p> <p>↓</p> <p>Running-&gt;ISO Value</p> <p>2013-06-01</p>  <p>2.490megohm</p> <p>ESC ▲ ▼</p>	<p>10. On the <b>ISO Value</b> screen, view the daily insulation resistance (ISO value) in the current month.</p> <p>Press <b>↵</b> to view the insulation resistance detected at the last connection to the power grid for each day of the current month.</p>

LCD	Procedure
<pre>Running-&gt;Input Data PV1 V/I: 461.9V/1.60A PV2 V/I: 461.9V/0.63A PV3 V/I: 186.4V/0.03A PV4 V/I: 186.3V/0.00A PV5 V/I: 187.7V/0.05A PV6 V/I: 187.7V/0.00A</pre>	<p>11. On the <b>Input Data</b> screen, view the voltage and current of each PV input.</p>
<pre>Running-&gt;Output Data Ua: 230.40V Ia: 4.86A Ub: 230.41V Ib: 4.87A Uc: 230.42V Ic: 4.88A Active power: 3390W</pre> <p>The preceding screen is displayed on all models except the SUN2000-28KTL.</p>	<p>12. On the <b>Output Data</b> screen, view the output voltage and current of each phase, active power, output frequency, and output power factor.</p> <p><b>NOTE</b> As the SUN2000-28KTL has three-phase, three-wire outputs, the output voltage and current are the line voltage and line current.</p>
<pre>Running-&gt;Cabinet Temp. Cabinet Temp. : 26.6degC</pre>	<p>13. On the <b>Cabinet Temp.</b> screen, view the internal temperature of the SUN2000.</p>

----End

## 7.2.2 Viewing Alarm Records

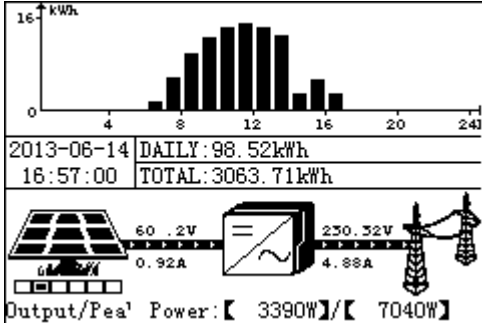

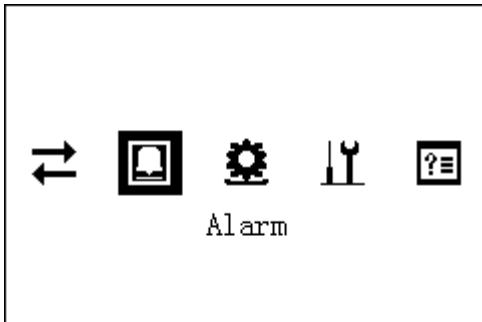


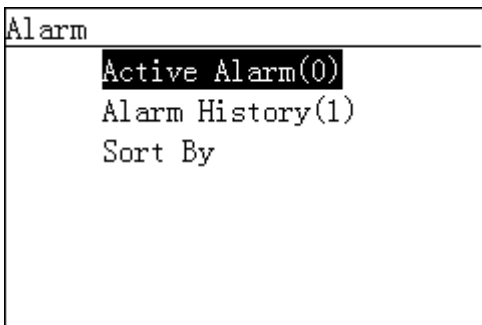


The monitoring panel displays the active and historical alarm records and allows setting of the sort mode of the alarm records.



### Context

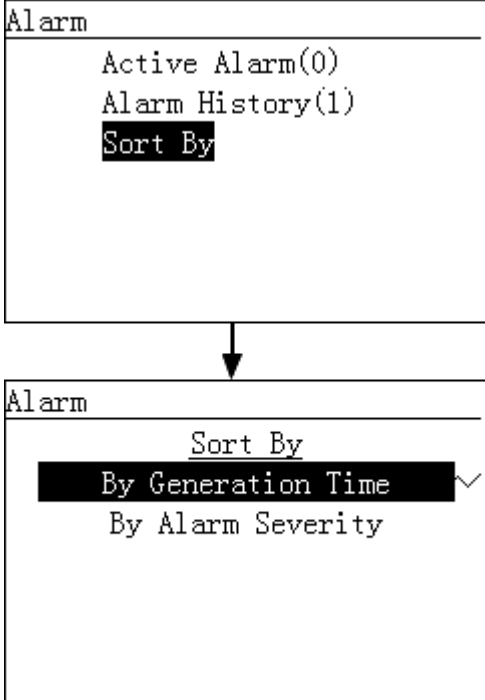
The LCD displays a maximum of 800 latest alarm records.

## Procedure

- The following table lists the procedure for viewing active and historical alarms and setting the alarm record sort mode. The parameter values in the figures are for reference only.

LCD	Procedure
	<p>1. On the default screen, press  to enter the main menu.</p>
	<p>2. Choose  and press .</p>
	<p>3. Select a menu by pressing  and press . You can view alarm details, or set the alarm record sort mode.</p> <ul style="list-style-type: none"> <li>To view active alarms, go to step 4.</li> <li>To view historical alarms, go to step 5.</li> <li>To set the alarm record sort mode, go to step 6.</li> </ul>

LCD	Procedure
<p>Alarm-&gt;Active alarm(1/3)</p> <p>①Fan Fault</p> <p>①Surge Arrester Fault</p> <p>①Version Mismatch</p> <p style="text-align: center;">↓</p> <p>Fan Fault(1/3)</p> <p>Alarm ID:320</p> <p>Severity:Minor ①</p> <p>    occur:2012-12-27 15:07:23</p> <p>    Info:</p> <p>    Error Code = 0x00000001</p>	<p>4. On the <b>Active Alarm (A/B)</b> screen, select an alarm record, and press  to view the alarm details.</p>
<p>Alarm-&gt;Alarm History(1/1)</p> <p>①Sting 1 Abnormal/ID:1</p> <p style="text-align: center;">↓</p> <p>Sting 1 Abnormal(1/1)</p> <p>Alarm ID:106</p> <p>Severity:Warning ①</p> <p>Generate:2013-04-28 18:36:08</p> <p>    Clear:2013-04-28 21:33:44</p> <p>    Info:</p> <p>    Reason ID = 1</p>	<p>5. On the <b>Alarm History (A/B)</b> screen, select an alarm record, and press  to view the alarm details.</p>

LCD	Procedure
	<p>6. On the <b>Sort By</b> screen, select <b>By Generation Time</b> or <b>By Alarm Severity</b>.</p>

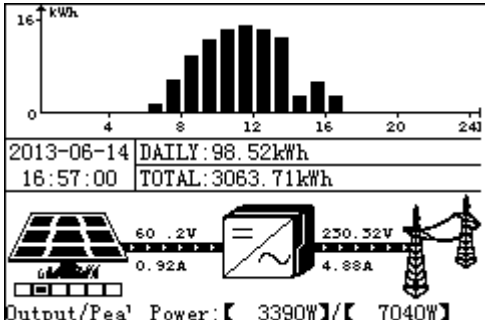

----End

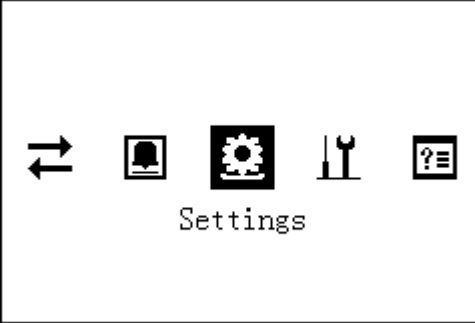


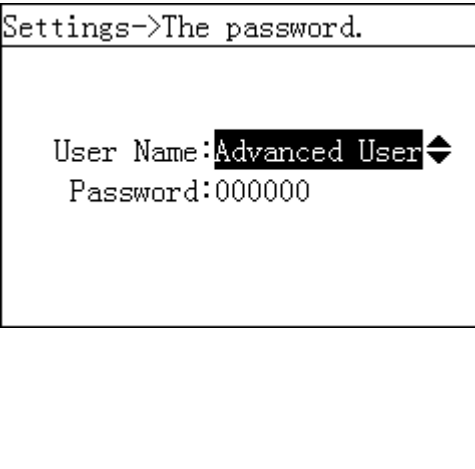



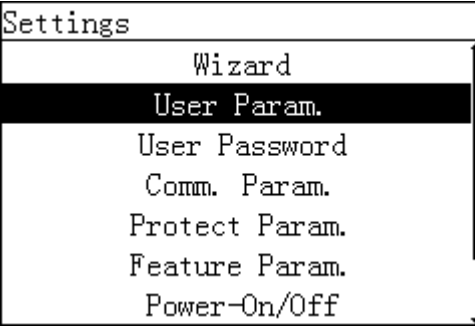

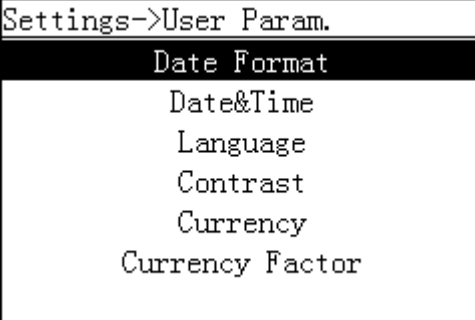


## 7.2.3 Setting System Time






The date format and date and time can be set on the monitoring panel.

### Procedure

- The following table lists the procedure for setting the date format and date and time. The parameter values in the figures are for reference only.

LCD Screen	Operation Procedure
	<p>1. On the default screen, press  to enter the main menu.</p>

LCD Screen	Operation Procedure
 <p>The LCD screen displays a menu with five icons: a left-right arrow, a bell, a gear (highlighted), a wrench, and a question mark. Below the icons, the word "Settings" is displayed.</p>	<p>2. Choose  and press .</p>
<p>Settings-&gt;The password.</p>  <p>The screen shows "User Name: Advanced User" with a selection arrow and "Password: 000000".</p>	<p>3. Enter the correct user name and password by pressing  or , and press .</p> <p><b>NOTE</b></p> <ul style="list-style-type: none"> <li>• The optional user names are <b>Common User</b> and <b>Advanced User</b>. The initial password for <b>Common User</b> and <b>Advanced User</b> is 000001. If you forgot the password, contact Huawei technical support for a dynamic password that is effective only on the current day. Change the password after login.</li> <li>• After the authentication is successful, the system keeps the authentication information for 30 seconds. If you exit from the <b>Settings</b> screen and log in again within 30 seconds, no authentication is required.</li> </ul>
 <p>The screen shows a list of settings: Wizard, User Param. (highlighted), User Password, Comm. Param., Protect Param., Feature Param., and Power-On/Off.</p> <p>An <b>Advanced User</b> has logged in to the SUN2000.</p>	<p>4. Choose <b>User Param.</b> and press .</p>
<p>Settings-&gt;User Param.</p>  <p>The screen shows a list of user parameters: Date Format (highlighted), Date&amp;Time, Language, Contrast, Currency, and Currency Factor.</p>	<p>5. Choose <b>Date Format</b> or <b>Date&amp;Time</b> by pressing , and press .</p>

LCD Screen	Operation Procedure
<pre>Settings-&gt;User Param.       Date Format       <b>Date&amp;Time</b>       Language       Contrast       Currency       Currency Factor</pre>	
<pre>Settings-&gt;User Param.       Date Format       <b>YYYY-MM-DD</b> ✓       MM-DD-YYYY       DD-MM-YYYY</pre>	<p>6. On the <b>Date Format</b> screen, select a date format, and press .</p>
<pre>Settings-&gt;User Param.       Date&amp;Time       <b>Date</b>:2013-06-17       Time:09:42:17</pre>	<p>7. On the <b>Date&amp;Time</b> screen, set the date and time, and press .</p> <ul style="list-style-type: none"> <li>To select a parameter, press . To set the parameter value, press  or .</li> <li>The date format is <b>YYYY-MM-DD</b>. <b>YYYY</b>, <b>MM</b>, and <b>DD</b> stand for year, month, and day respectively. The time format is <b>hh-mm-ss</b>. <b>hh</b>, <b>mm</b>, and <b>ss</b> stand for hour, minute, and second respectively.</li> </ul>

----End

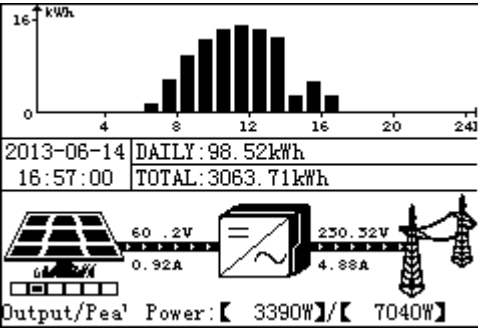




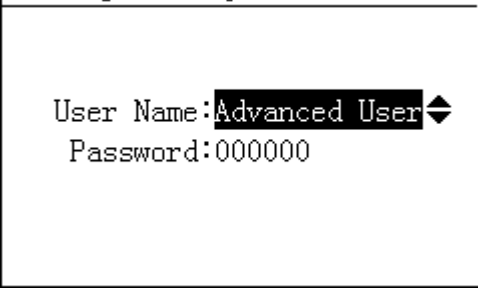



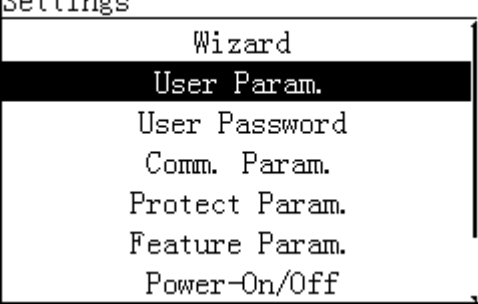

## 7.2.4 Setting the System Language

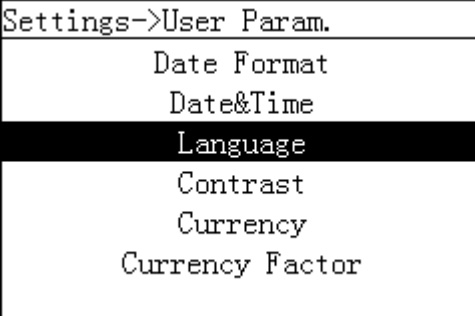
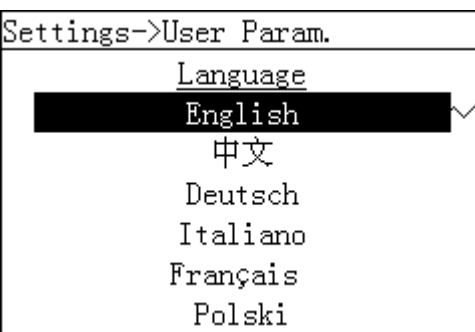
This topic describes how to set the SUN2000 display language on the monitoring panel.

### Procedure

- The following table lists the procedure for setting the display language. The parameter values in the figures are for reference only.



LCD	Procedure
	<p>1. On the default screen, press  to enter the main menu.</p>
	<p>2. Choose  and press .</p>
<p>Settings-&gt;The password.</p> 	<p>3. Enter the correct user name and password by pressing  or , and press .</p> <p><b>NOTE</b></p> <ul style="list-style-type: none"> <li>The optional user names are <b>Common User</b> and <b>Advanced User</b>. The initial password for <b>Common User</b> and <b>Advanced User</b> is <i>000001</i>. If you forgot the password, contact Huawei technical support for a dynamic password that is effective only on the current day. Change the password after login.</li> <li>After the authentication is successful, the system keeps the authentication information for 30 seconds. If you exit from the <b>Settings</b> screen and log in again within 30 seconds, no authentication is required.</li> </ul>
<p>Settings</p>  <p>An <b>Advanced User</b> has logged in to the SUN2000.</p>	<p>4. Choose <b>User Param.</b> and press .</p>

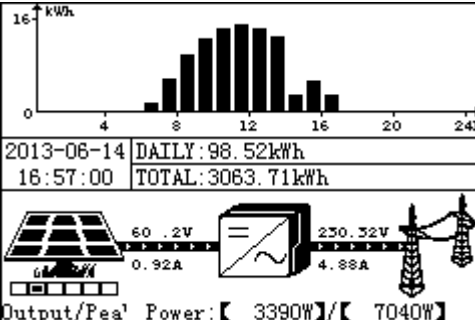
LCD	Procedure
 <p>Settings-&gt;User Param. Date Format Date&amp;Time <b>Language</b> Contrast Currency Currency Factor</p>	<p>5. Choose <b>Language</b> by pressing ▼ and press ↵.</p>
 <p>Settings-&gt;User Param. Language <b>English</b> ✓ 中文 Deutsch Italiano Français Polski</p>	<p>6. On the <b>Language</b> screen, select a display language, and press ↵. The screens will be displayed in the selected language.</p>

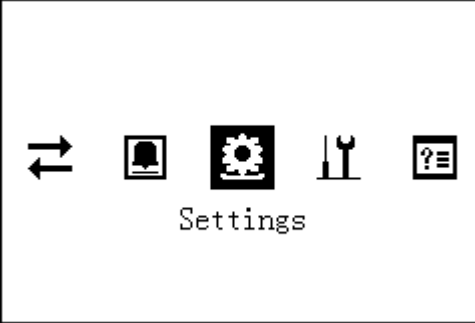


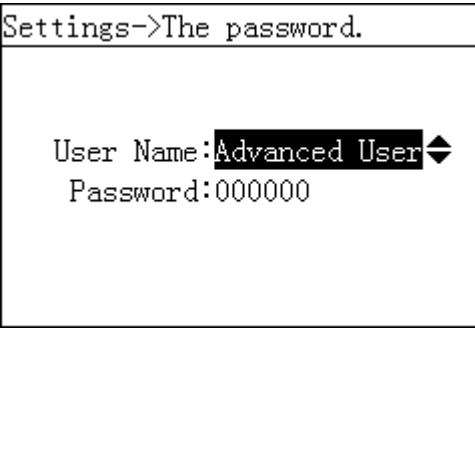



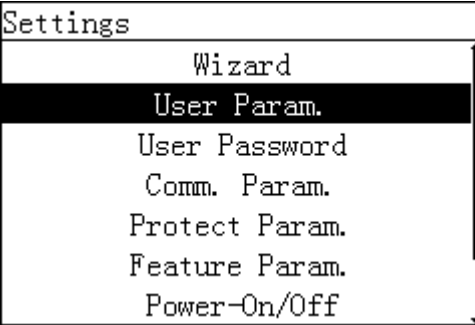

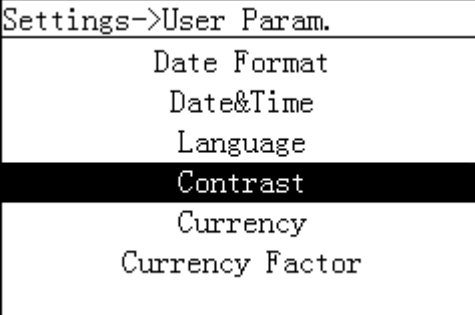


----End

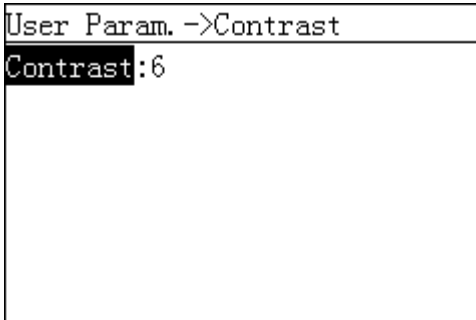
## 7.2.5 Setting the Contrast

### Procedure

- The following table lists the procedure for setting the contrast. The parameter values in the figures are for reference only.

LCD Screen	Procedure
 <p>16 kWh 0 4 8 12 16 20 24</p> <p>2013-06-14 DAILY: 98.52kWh 16:57:00 TOTAL: 3063.71kWh</p> <p>60.2V 0.92A 250.32V 4.88A</p> <p>Output/Pea' Power: 【 3390W】/【 7040W】</p>	<p>1. On the default screen, press ↵ to enter the main menu.</p>

LCD Screen	Procedure
 <p>The LCD screen displays a menu with five icons: a left-right arrow, a bell, a gear (highlighted), a wrench, and a question mark. Below the icons, the word "Settings" is displayed.</p>	<p>2. Choose  and press .</p>
<p>Settings-&gt;The password.</p>  <p>The screen shows "User Name: Advanced User" with a right-pointing arrow and "Password: 000000".</p>	<p>3. Enter the correct user name and password by pressing  or , and press .</p> <p><b>NOTE</b></p> <ul style="list-style-type: none"> <li>• The optional user names are <b>Common User</b> and <b>Advanced User</b>. The initial password for <b>Common User</b> and <b>Advanced User</b> is <i>000001</i>. If you forgot the password, contact Huawei technical support for a dynamic password that is effective only on the current day. Change the password after login.</li> <li>• After the authentication is successful, the system keeps the authentication information for 30 seconds. If you exit from the <b>Settings</b> screen and log in again within 30 seconds, no authentication is required.</li> </ul>
 <p>The screen shows a list of settings: Wizard, User Param. (highlighted), User Password, Comm. Param., Protect Param., Feature Param., and Power-On/Off.</p> <p>An <b>Advanced User</b> has logged in to the SUN2000.</p>	<p>4. Choose <b>User Param.</b> and press .</p>
<p>Settings-&gt;User Param.</p>  <p>The screen shows a list of user parameters: Date Format, Date&amp;Time, Language, Contrast (highlighted), Currency, and Currency Factor.</p>	<p>5. Choose <b>Contrast</b> by pressing , and press .</p>

LCD Screen	Procedure
	<p>6. On the <b>Contrast</b> screen, press ▲ and ▼ to set the contrast.</p>

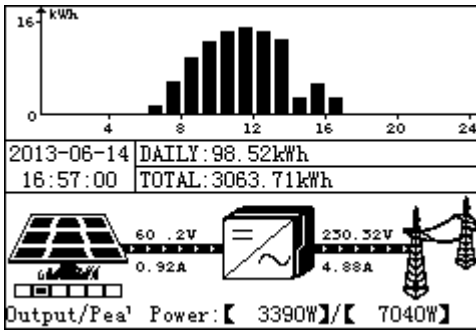
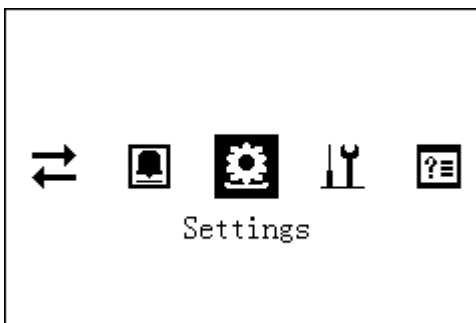

----End

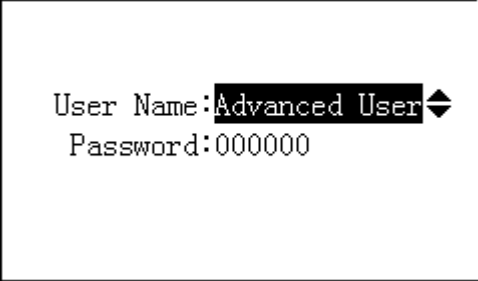


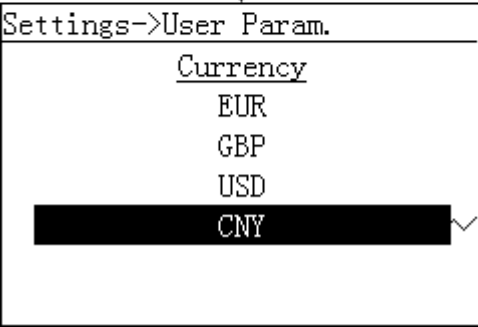
## 7.2.6 Setting the Currency and Currency Factor

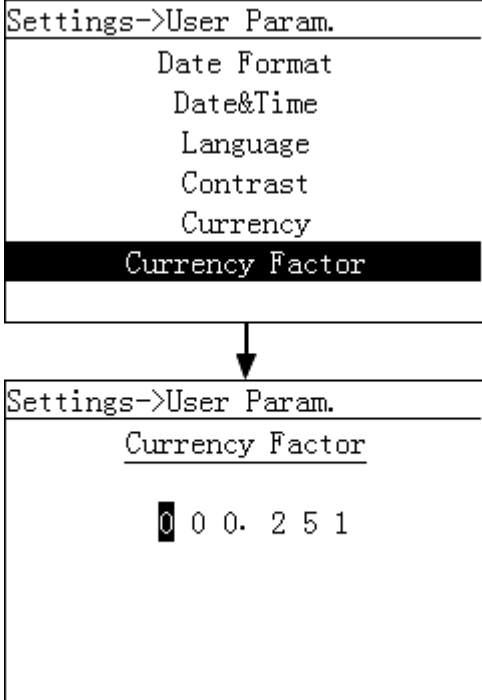
The currency and the revenue per kilowatt hour can be set on the monitoring panel, which allows the calculation of revenue from the energy yield.

### Procedure

- The following table lists the procedure for setting the currency and currency factor. The parameter values in the figures are for reference only.

LCD Screen	Procedure
	<p>1. On the default screen, press ↵ to enter the main menu.</p>
	<p>2. Choose  and press ↵.</p>

LCD Screen	Procedure
<p>Settings-&gt;The password.</p> 	<p>3. Enter the correct user name and password by pressing ▲ or ▼, and press ↵.</p> <p><b>NOTE</b></p> <ul style="list-style-type: none"> <li>The optional user names are <b>Common User</b> and <b>Advanced User</b>. The initial password for <b>Common User</b> and <b>Advanced User</b> is <i>000001</i>. If you forgot the password, contact Huawei technical support for a dynamic password that is effective only on the current day. Change the password after login.</li> <li>After the authentication is successful, the system keeps the authentication information for 30 seconds. If you exit from the <b>Settings</b> screen and log in again within 30 seconds, no authentication is required.</li> </ul>
<p>Settings</p>  <p>An <b>Advanced User</b> has logged in to the SUN2000.</p>	<p>4. Choose <b>User Param.</b> and press ↵.</p>
<p>Settings-&gt;User Param.</p>  <p style="text-align: center;">↓</p> <p>Settings-&gt;User Param.</p> 	<p>5. Set the currency.</p> <ol style="list-style-type: none"> <li>Select <b>Currency</b> by pressing ▼, and press ↵.</li> <li>Select a currency and press ↵.</li> </ol>

LCD Screen	Procedure
 <p>Settings-&gt;User Param. Date Format Date&amp;Time Language Contrast Currency <b>Currency Factor</b></p> <p>Settings-&gt;User Param. Currency Factor 000.251</p>	<p>6. Set the currency factor.</p> <p><b>NOTE</b> The currency factor is the local price of electricity.</p> <ol style="list-style-type: none"> <li>Select <b>Currency Factor</b> by pressing ▼, and press ↵.</li> <li>Set the currency factor by pressing ▲ or ▼, and press ↵.</li> </ol>

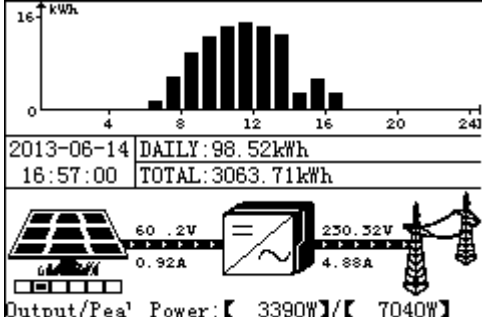
----End




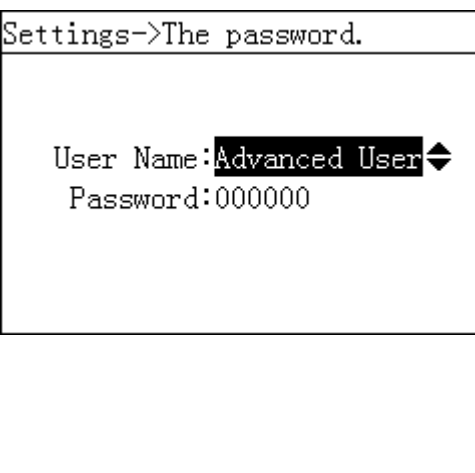



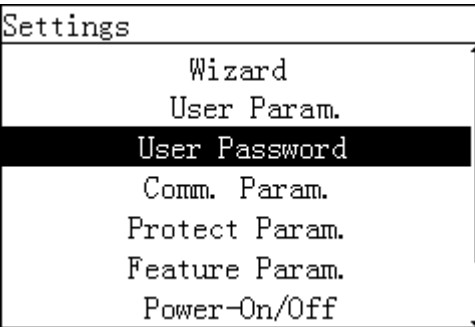


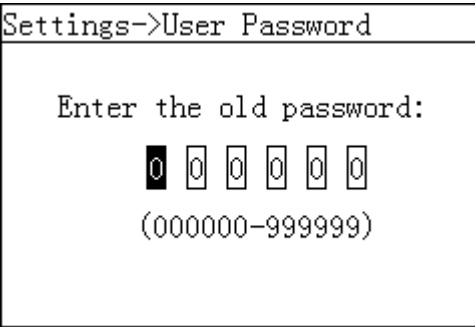




## 7.2.7 Changing a User Password

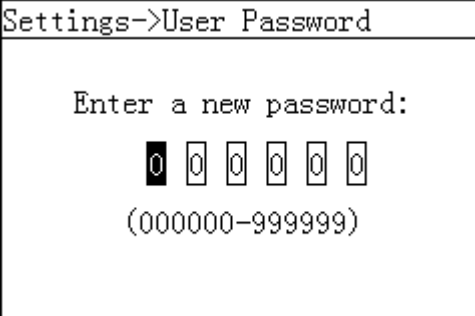




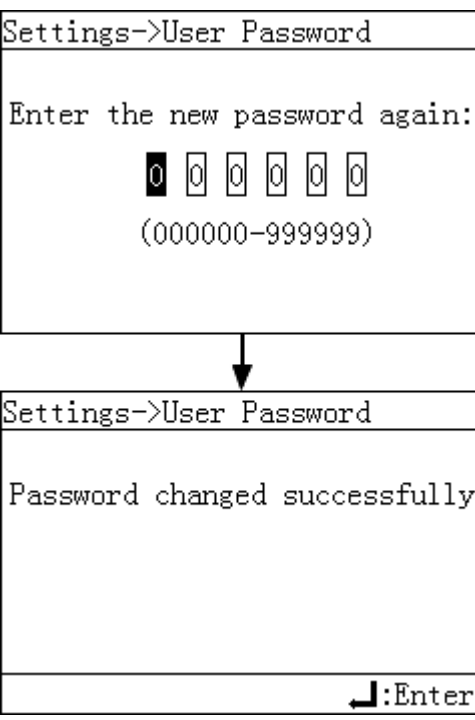

The user password can be changed on the monitoring panel.

### Procedure

- The following table lists the procedure for setting a new password. The parameter values in the figures are for reference only.

LCD Screen	Procedure
 <p>16 kWh 0 4 8 12 16 20 24</p> <p>2013-06-14 DAILY: 98.52kWh 16:57:00 TOTAL: 3063.71kWh</p> <p>60.2V 0.92A 250.32V 4.88A</p> <p>Output/Pea' Power: 【 3390W】/【 7040W】</p>	<ol style="list-style-type: none"> <li>On the default screen, press ↵ to enter the main menu.</li> </ol>

LCD Screen	Procedure
 <p>The LCD screen displays a menu with five icons: a left-right arrow, a speech bubble, a gear, a wrench, and a question mark. The gear icon is highlighted with a black background. Below the icons, the word "Settings" is displayed.</p>	<p>2. Choose  and press .</p>
<p>Settings-&gt;The password.</p>  <p>The LCD screen shows the text "Settings-&gt;The password." at the top. Below it, "User Name: Advanced User" is displayed with a right-pointing arrow next to it. Underneath, "Password: 000000" is shown.</p>	<p>3. Enter the correct user name and password by pressing  or , and press .</p> <p><b>NOTE</b></p> <ul style="list-style-type: none"> <li>• The optional user names are <b>Common User</b>, <b>Advanced User</b>, and <b>Special User</b>. The initial password for these accounts is <i>000001</i>. If you forgot the password, contact Huawei technical support for a dynamic password that is effective only on the current day. Change the password after login.</li> <li>• After the authentication is successful, the system keeps the authentication information for 30 seconds. If you exit from the <b>Settings</b> screen and log in again within 30 seconds, no authentication is required.</li> </ul>
 <p>The LCD screen shows the "Settings" menu with the following options: Wizard, User Param., User Password (highlighted with a black background), Comm. Param., Protect Param., Feature Param., and Power-On/Off.</p>	<p>4. Choose <b>User Password</b> by pressing , and press .</p>
<p>Settings-&gt;User Password</p>  <p>The LCD screen shows the text "Settings-&gt;User Password" at the top. Below it, "Enter the old password:" is displayed. Underneath, there are six empty boxes for entering digits, followed by the range "(000000-999999)".</p>	<p>5. Enter the old password and press . Increase or decrease the value by pressing  or . Switch between digits by pressing .</p>

LCD Screen	Procedure
	<p>6. Enter a new password and press . Increase or decrease the value by pressing  or . Switch between digits by pressing .</p>
	<p>7. Enter the new password again and press .</p> <p><b>NOTE</b> Ensure that the re-entered password is the same as the new password. Otherwise, an error message will be displayed.</p> <p>After the password has been changed, the LCD displays a success message.</p>

----End

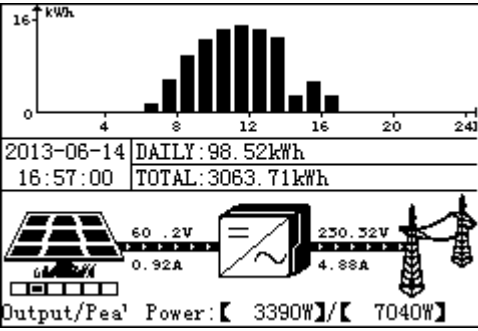




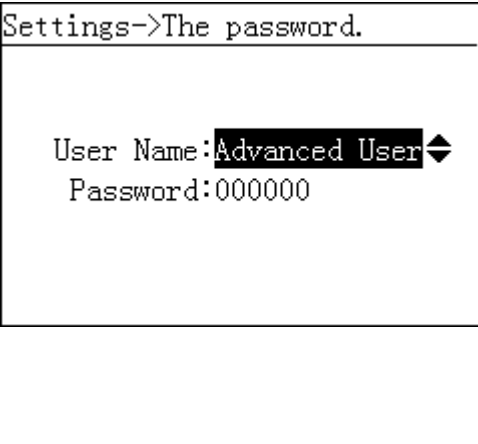



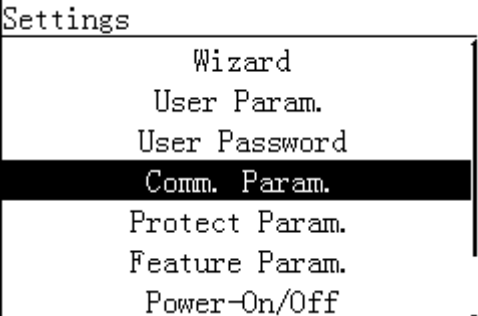

## 7.2.8 Setting Communications Parameters

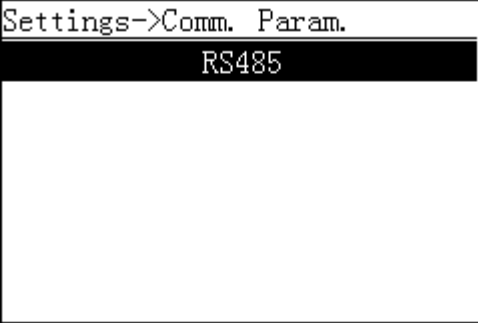

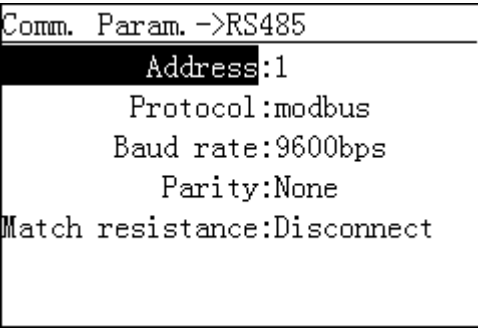

RS485 communications parameters such as the address, protocol, baud rate, and check mode can be set on the monitoring panel.

### Procedure

- The following table lists the procedure for setting communications parameters. The parameter values in the figures are for reference only.



LCD Screen	Procedure
	<p>1. On the default screen, press  to enter the main menu.</p>
	<p>2. Choose  and press .</p>
<p>Settings-&gt;The password.</p> 	<p>3. Enter the correct user name and password by pressing  or , and press .</p> <p><b>NOTE</b></p> <ul style="list-style-type: none"> <li>The optional user name is <b>Advanced User</b>. The initial password for <b>Advanced User</b> is <b>000001</b>. If you forgot the password, contact Huawei technical support for a dynamic password that is effective only on the current day. Change the password after login.</li> <li>After the authentication is successful, the system keeps the authentication information for 30 seconds. If you exit from the <b>Settings</b> screen and log in again within 30 seconds, no authentication is required.</li> </ul>
	<p>4. Choose <b>Comm. Param.</b>, and press .</p>

LCD Screen	Procedure
	<p>5. On the <b>Comm. Param.</b> screen, press .</p>
	<p>6. Set <b>Address, Protocol, Baud Rate, and Match Resistance</b>, and press .</p> <ul style="list-style-type: none"> <li>• The optional addresses range from <b>1</b> to <b>247</b>.</li> <li>• The optional protocol is <b>modbus</b>.</li> <li>• The optional baud rates are <b>4800bps, 9600bps, and 19200bps</b>.</li> <li>• The optional parities are <b>None, Even parity, Odd parity</b>.</li> <li>• The optional values of match resistance are <b>Disconnect</b> and <b>Connect</b>.</li> </ul> <p>This parameter is set to <b>Disconnect</b> by default. If signals are distorted or the communication is of poor quality because of a lengthy communications cable, set the parameter to <b>Connect</b>.</p>

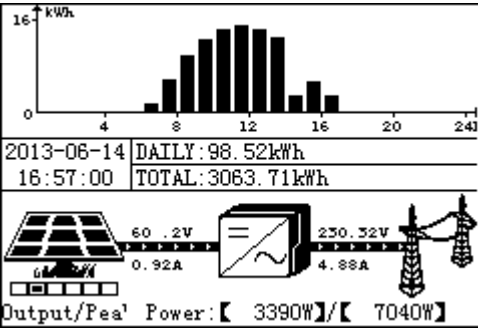




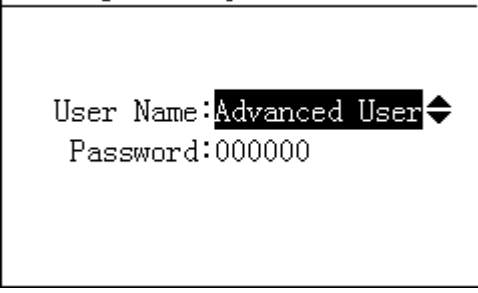



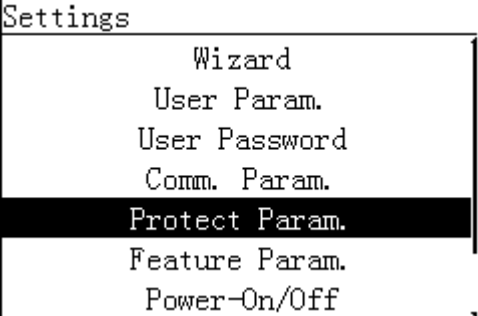

----End

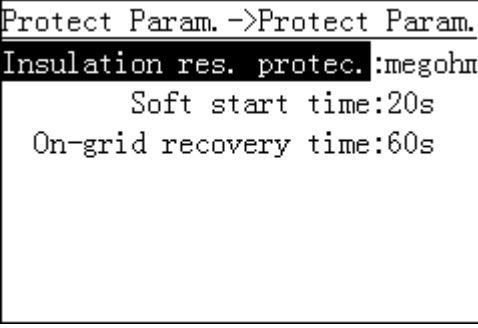

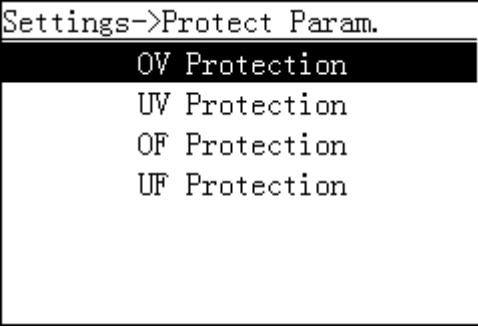

## 7.2.9 Setting Protection Parameters

SUN2000 protection parameters can be set on the monitoring panel.

### Procedure

- The following table lists the procedure for setting protection parameters. The parameter values in the figures are for reference only.

LCD Screen	Procedure
 <p>Output/Pea' Power:【 3390W】/【 7040W】</p>	<p>1. On the default screen, press  to enter the main menu.</p>
 <p>Settings</p>	<p>2. Choose  and press .</p>
<p>Settings-&gt;The password.</p>  <p>User Name:Advanced User◆ Password:000000</p>	<p>3. Enter the correct user name and password by pressing  or , and press .</p> <p><b>NOTE</b></p> <ul style="list-style-type: none"> <li>• The optional user names are <b>Advanced User</b> and <b>Special User</b>. The initial password for <b>Advanced User</b> and <b>Special User</b> is <i>000001</i>. If you forgot the password, contact Huawei technical support for a dynamic password that is effective only on the current day. Change the password after login.</li> <li>• After the authentication is successful, the system keeps the authentication information for 30 seconds. If you exit from the <b>Settings</b> screen and log in again within 30 seconds, no authentication is required.</li> </ul>
<p>Settings</p>  <p>Wizard User Param. User Password Comm. Param. <b>Protect Param.</b> Feature Param. Power-On/Off</p> <p>An <b>Advanced User</b> has logged in to the SUN2000.</p>	<p>4. Choose <b>Protect Param.</b> and press .</p> <ul style="list-style-type: none"> <li>• If you have logged in to the SUN2000 as <b>Advanced User</b>, perform step 5.</li> <li>• If you have logged in to the SUN2000 as <b>Special User</b>, perform step 6.</li> </ul>

LCD Screen	Procedure
 <p>An <b>Advanced User</b> has logged in to the SUN2000.</p>	<p>5. Set <b>Insulation res. protec.</b>, <b>Soft start time</b> and <b>On-grid recovery time</b>, and press .</p> <p>The parameters displayed vary with the setting of <b>Grid Code</b>.</p>
 <p>A <b>Special User</b> has logged in to the SUN2000.</p>	<p>6. Select a parameter and press .</p>

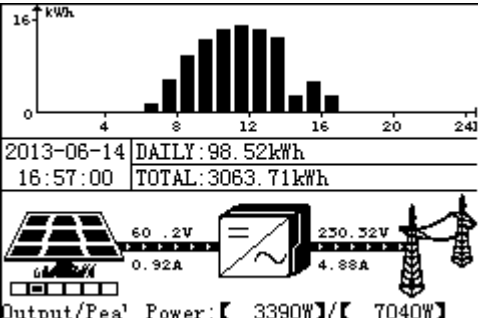

----End




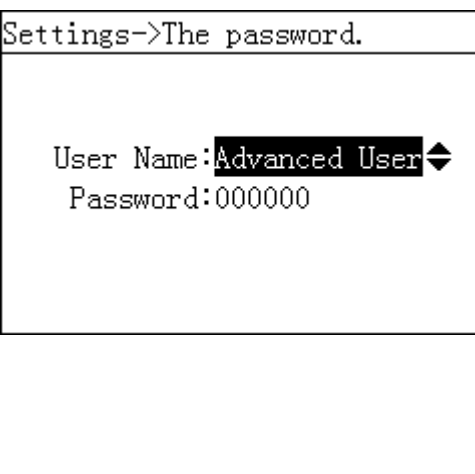



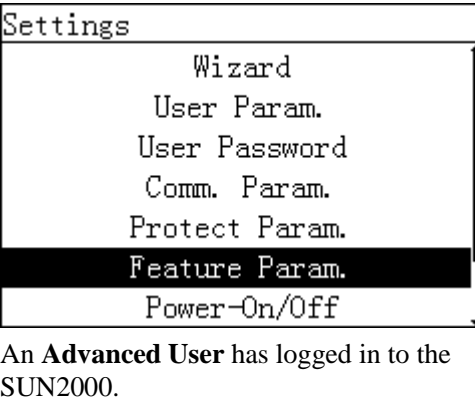

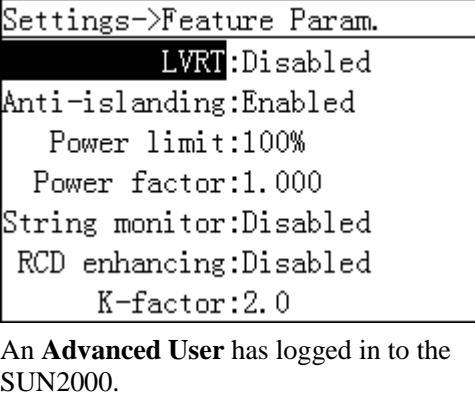

## 7.2.10 Setting Feature Parameters

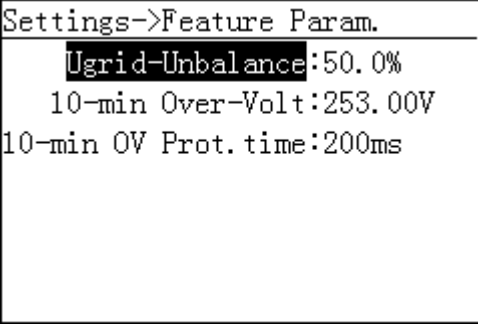

SUN2000 feature parameters can be set on the monitoring panel.

### Procedure

- The following table lists the procedure for setting feature parameters. The parameter values in the figures are for reference only.

LCD Screen	Procedure
	<p>1. On the default screen, press  to enter the main menu.</p>

LCD Screen	Procedure
 <p>The LCD screen displays a menu with five icons: a left-right arrow, a bell, a gear (highlighted), a wrench, and a question mark. Below the icons, the word "Settings" is displayed.</p>	<p>2. Choose  and press .</p>
<p>Settings-&gt;The password.</p>  <p>The LCD screen shows the text "Settings-&gt;The password." at the top. Below it, there are two input fields: "User Name: Advanced User" with a dropdown arrow and "Password: 000000".</p>	<p>3. Enter the correct user name and password by pressing  or , and press .</p> <p><b>NOTE</b></p> <ul style="list-style-type: none"> <li>The optional user names are <b>Advanced User</b> and <b>Special User</b>. The initial password for <b>Advanced User</b> and <b>Special User</b> is 000001. If you forgot the password, contact Huawei technical support for a dynamic password that is effective only on the current day. Change the password after login.</li> <li>After the authentication is successful, the system keeps the authentication information for 30 seconds. If you exit from the <b>Settings</b> screen and log in again within 30 seconds, no authentication is required.</li> </ul>
<p>Settings</p>  <p>The LCD screen shows a list of settings options: Wizard, User Param., User Password, Comm. Param., Protect Param., Feature Param. (highlighted), and Power-On/Off.</p> <p>An <b>Advanced User</b> has logged in to the SUN2000.</p>	<p>4. Choose <b>Feature Param.</b> and press .</p> <ul style="list-style-type: none"> <li>If you have logged in to the SUN2000 as <b>Advanced User</b>, perform step 5.</li> <li>If you have logged in to the SUN2000 as <b>Special User</b>, perform step 6.</li> </ul>
<p>Settings-&gt;Feature Param.</p>  <p>The LCD screen shows the text "Settings-&gt;Feature Param." at the top. Below it, several settings are listed: LVRT: Disabled, Anti-islanding: Enabled, Power limit: 100%, Power factor: 1.000, String monitor: Disabled, RCD enhancing: Disabled, and K-factor: 2.0.</p> <p>An <b>Advanced User</b> has logged in to the SUN2000.</p>	<p>5. Set <b>LVRT</b>, <b>Anti-islanding</b>, <b>Power limit</b>, <b>Power factor</b>, <b>String monitor</b>, and press .</p> <p>If <b>String monitor</b> is set to <b>Enable</b>, the SUN2000 monitors the operating status of all the connected PV strings in real time. A warning is generated as a reminder to rectify an abnormality that has been detected (for example, modules are shielded for a long time or are faulty).</p>

LCD Screen	Procedure
 <p>A <b>Special User</b> has logged in to the SUN2000.</p>	<p>6. Set <b>Ugrid-Unbalance</b>, <b>10-min Over-Volt</b>, and <b>10-min OV Prot. time</b>, and press .</p> <p>The parameters displayed vary with the setting of <b>Grid Code</b>.</p>

----End

## 7.2.11 Setting Isolation Parameters

SUN2000 isolation parameters can be set on the monitoring panel.

### Context

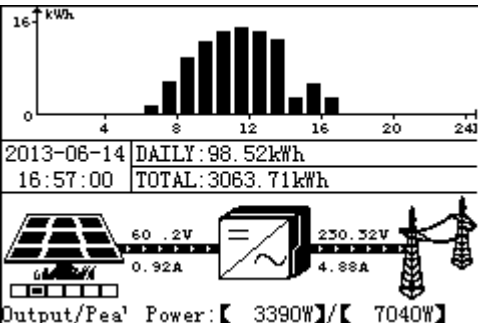



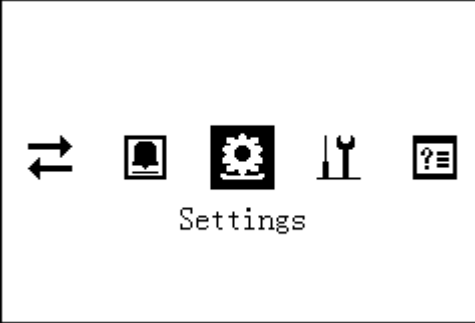


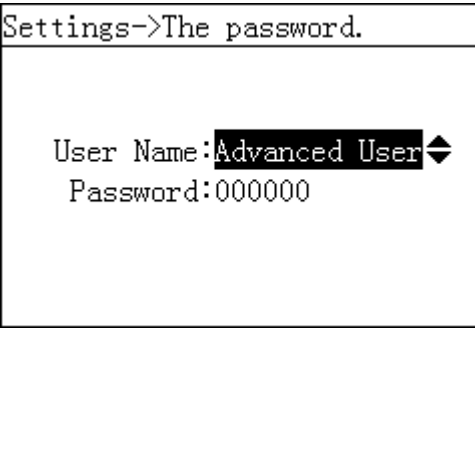



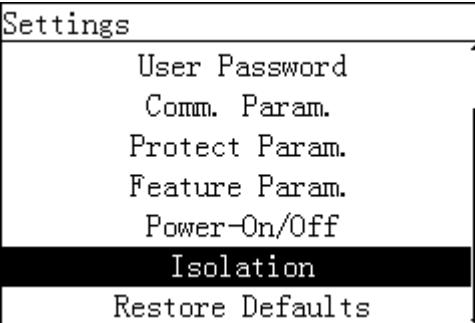

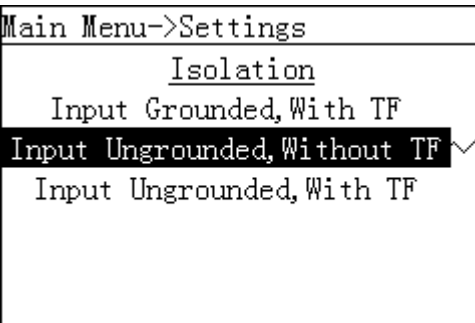

### NOTICE

If PV strings are grounded, install a three-phase four-wire isolation transformer and set **Isolation** to **Input Grounded, With TF**.

### Procedure

- The following table lists the procedure for setting isolation parameters. The parameter values in the figures are for reference only.

LCD	Procedure
	<p>1. On the default screen, press  to enter the main menu.</p>

LCD	Procedure
 <p>The LCD screen displays a menu with five icons: a left-right arrow, a bell, a gear (highlighted), a wrench, and a question mark. Below the icons, the word "Settings" is centered.</p>	<p>2. Choose  and press .</p>
<p>Settings-&gt;The password.</p>  <p>The screen shows "User Name: Advanced User" with a right-pointing arrow and "Password: 000000".</p>	<p>3. Enter the correct user name and password by pressing  or , and press .</p> <p><b>NOTE</b></p> <ul style="list-style-type: none"> <li>The optional user names are <b>Common User</b> and <b>Advanced User</b>. The initial password for <b>Common User</b> and <b>Advanced User</b> is 000001. If you forgot the password, contact Huawei technical support for a dynamic password that is effective only on the current day. Change the password after login.</li> <li>After the authentication is successful, the system keeps the authentication information for 30 seconds. If you exit from the <b>Settings</b> screen and log in again within 30 seconds, no authentication is required.</li> </ul>
 <p>The screen shows a list of settings: User Password, Comm. Param., Protect Param., Feature Param., Power-On/Off, Isolation (highlighted), and Restore Defaults.</p>	<p>4. Choose <b>Isolation</b> and press .</p>
<p>Main Menu-&gt;Settings</p>  <p>The screen shows "Isolation" with four options: Input Grounded, With TF; Input Ungrounded, Without TF (checked); and Input Ungrounded, With TF.</p>	<p>5. Select an isolation method and press .</p>

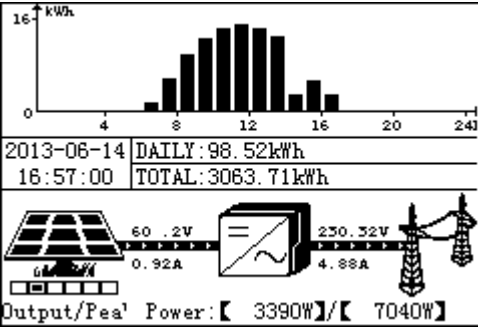

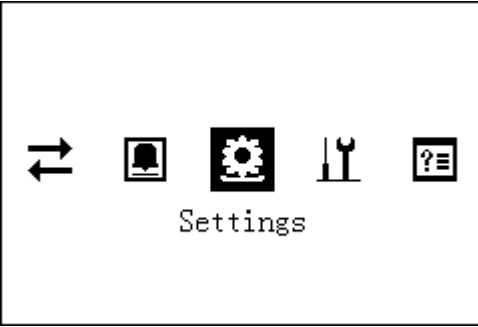


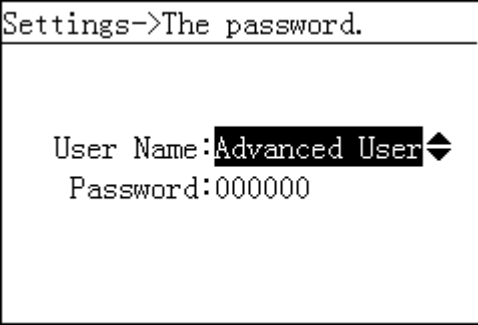



----End

## 7.2.12 Manually Starting and Shutting down the SUN2000

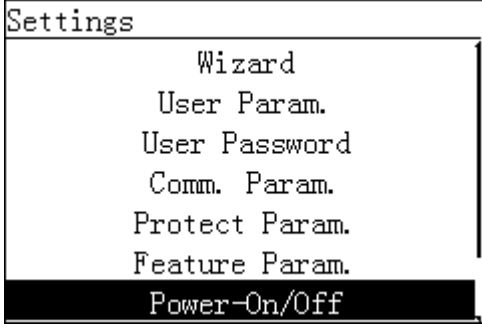

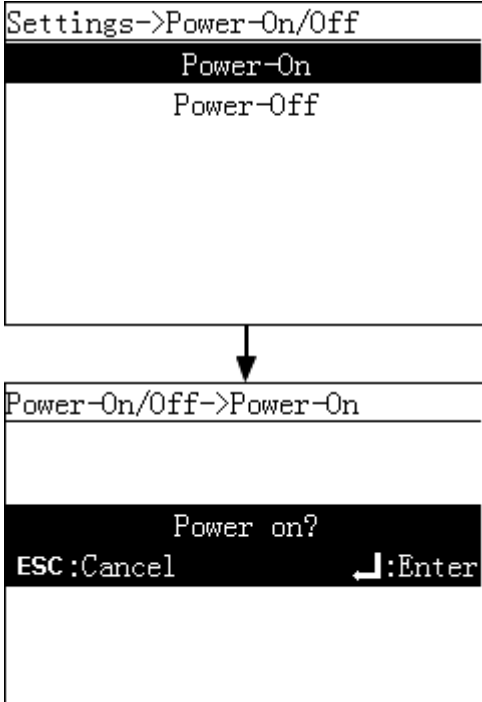



The SUN2000 can be manually started and shut down on the monitoring panel.

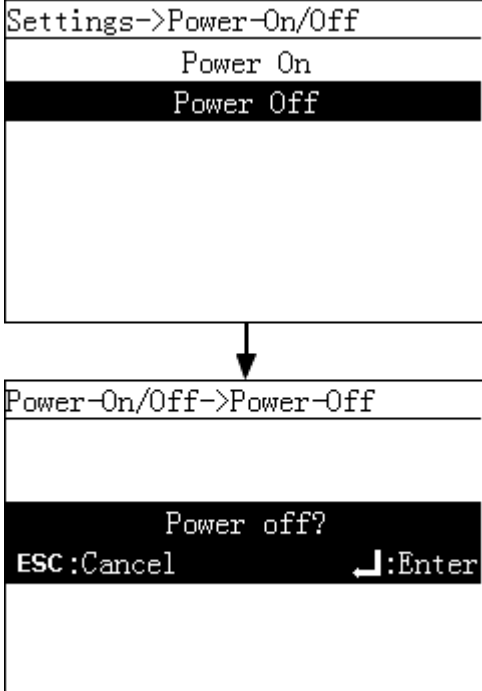


### Procedure

- The following table lists the procedure for manually starting and shutting down the SUN2000. The parameter values in the figures are for reference only.

LCD Screen	Procedure
 <p>16 kWh</p> <p>2013-06-14 DAILY: 98.52kWh 16:57:00 TOTAL: 3063.71kWh</p> <p>60.2V 0.92A 250.32V 4.88A</p> <p>Output/Pea' Power: 【 3390W】/【 7040W】</p>	<p>1. On the default screen, press  to enter the main menu.</p>
 <p>Settings</p>	<p>2. Choose  and press .</p>
<p>Settings-&gt;The password.</p>  <p>User Name: Advanced User ◆</p> <p>Password: 000000</p>	<p>3. Enter the correct user name and password by pressing  or , and press .</p> <p><b>NOTE</b></p> <ul style="list-style-type: none"> <li>The optional user names are <b>Common User</b>, <b>Advanced User</b>, and <b>Special User</b>. The initial password for these accounts is 000001. If you forgot the password, contact Huawei technical support for a dynamic password that is effective only on the current day. Change the password after login.</li> <li>After the authentication is successful, the system keeps the authentication information for 30 seconds. If you exit from the <b>Settings</b> screen and log in again within 30 seconds, no authentication is required.</li> </ul>



LCD Screen	Procedure
 <p>Settings</p> <p>Wizard</p> <p>User Param.</p> <p>User Password</p> <p>Comm. Param.</p> <p>Protect Param.</p> <p>Feature Param.</p> <p><b>Power-On/Off</b></p> <p>An <b>Advanced User</b> has logged in to the SUN2000.</p>	<p>4. Choose <b>Power-On/Off</b> and press .</p> <ul style="list-style-type: none"> <li>To manually start the SUN2000, go to step 5.</li> <li>To manually shut down the SUN2000, go to step 6.</li> </ul>
 <p>Settings-&gt;Power-On/Off</p> <p><b>Power-On</b></p> <p>Power-Off</p> <p>↓</p> <p>Power-On/Off-&gt;Power-On</p> <p>Power on?</p> <p>ESC:Cancel      :Enter</p>	<p>5. Manually start the SUN2000.</p> <p>a. Choose <b>Power-On</b> and press .</p> <p>b. Press  again to confirm the operation.</p>

LCD Screen	Procedure
	<p>6. Manually shut down the SUN2000.</p> <ol style="list-style-type: none"> <li>Choose <b>Power-Off</b> and press .</li> <li>Press  again to confirm the operation.</li> </ol>

----End

## 7.2.13 Restoring Factory Settings

Factory settings for the SUN2000 can be restored on the monitoring panel. The operation will restore all configured parameters except the current date and time to their factory settings. The operation will not impact alarm records, system logs, and operating information.

### Context

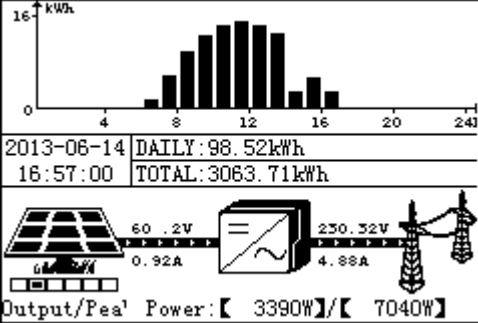

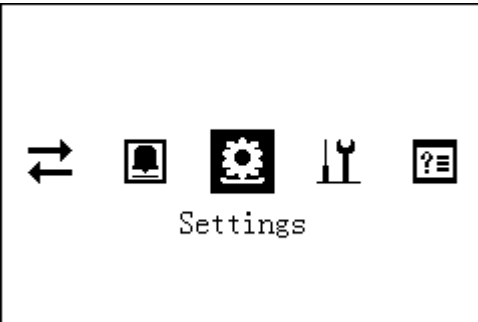


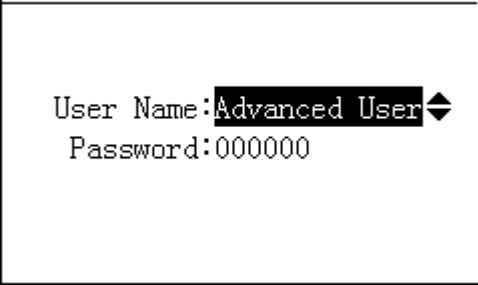







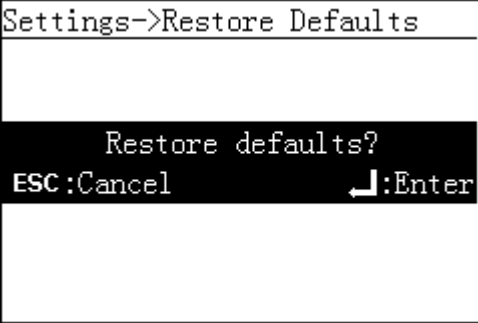

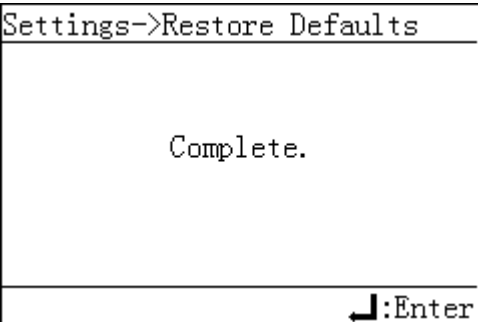

### NOTICE

- Perform this operation with caution because all configured parameters except the current date and time will be restored to their factory settings.
- If PV strings are grounded, install a three-phase four-wire isolation transformer and set **Isolation to Input Grounded, With TF**.

### Procedure

- The following table lists the procedure for restoring factory settings. The parameter values in the figures are for reference only.

LCD	Procedure
 <p>2013-06-14 16:57:00 DAILY: 98.52kWh TOTAL: 3063.71kWh Output/Peak Power: [ 3390W ] / [ 7040W ]</p>	<p>1. On the default screen, press  to enter the main menu.</p>
 <p>Settings</p>	<p>2. Choose  and press .</p>
<p>Settings-&gt;The password.</p>  <p>User Name: Advanced User Password: 000000</p>	<p>3. Enter the correct user name and password by pressing  or , and press .</p> <p><b>NOTE</b></p> <ul style="list-style-type: none"> <li>The optional user names are <b>Advanced User</b> and <b>Special User</b>. The initial password for <b>Advanced User</b> and <b>Special User</b> is <i>000001</i>. If you forgot the password, contact Huawei technical support for a dynamic password that is effective only on the current day. Change the password after login.</li> <li>After the authentication is successful, the system keeps the authentication information for 30 seconds. If you exit from the <b>Settings</b> screen and log in again within 30 seconds, no authentication is required.</li> </ul>
<p>Settings</p>  <p>User Password Comm. Param. Protect Param. Feature Param. Power-On/Off Isolation Restore Defaults</p> <p>An <b>Advanced User</b> has logged in to the SUN2000.</p>	<p>4. Choose <b>Restore Defaults</b> and press .</p>

LCD	Procedure
	<p>5. On the displayed screen, press .</p>
	<p>6. Press  to complete the settings.</p> <p><b>NOTE</b> After factory settings are restored, the display language is English and the <b>Wizard</b> screen is displayed.</p>

----End

## 7.2.14 Enabling USB Guide Functions

USB guide functions can be enabled on the monitoring panel. Upgrade firmware, import configurations, export configurations and export data with a USB flash drive when USB guide functions have been enabled.

### Context

The USB guide functions are described as follows:

- Firmware upgrade: Upgrade the SUN2000 software.



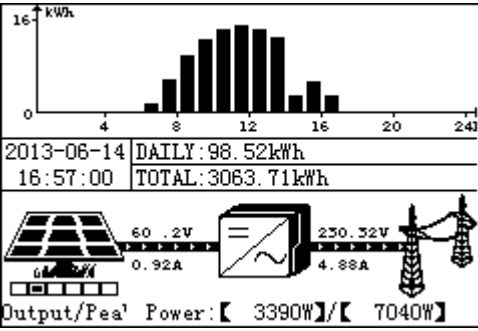




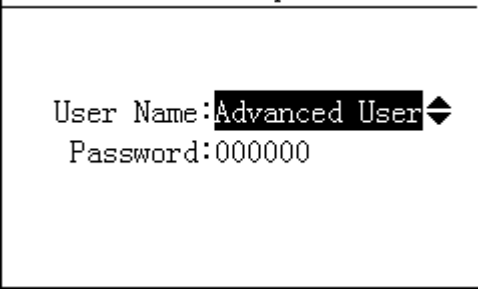




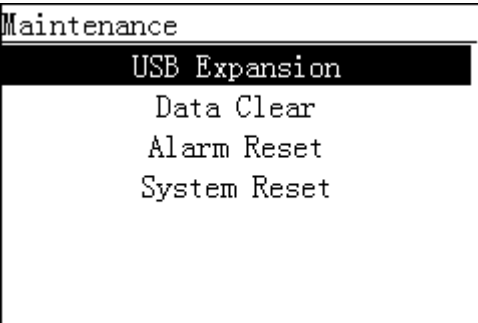

**NOTE**

Inverters can be upgraded in batches using the SmartLogger or NMS.

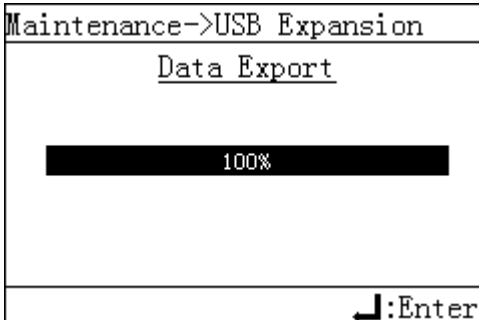

- Configuration importing: Load an existing configuration file to the SUN2000 and update the configuration parameters in batches (all parameter settings on the LCD).
- Configuration exporting: Download the configuration parameters to the local computer as a file.
- Data exporting: Download the alarm records, performance data, and logs to the local computer as a file to facilitate analysis.

### Procedure

- The following table lists the procedure for enabling USB guide functions. The parameter values in the figures are for reference only.

LCD	Procedure
 <p>2013-06-14 16:57:00 DAILY: 98.52kWh TOTAL: 3063.71kWh</p> <p>Output/Peak Power: [ 3390W ] / [ 7040W ]</p>	<p>1. On the default screen, press  to enter the main menu.</p> <p><b>NOTE</b> On the default screen, after you insert a USB flash drive and log in to the system, the USB expansion screen is displayed. In this case, perform operations in step 5.</p>
 <p>Maintenance</p>	<p>2. Choose  and press .</p>
<p>Maintenance-&gt;The password.</p>  <p>User Name: Advanced User  Password: 000000</p>	<p>3. Enter the correct user name and password by pressing  or , and press .</p> <p><b>NOTE</b></p> <ul style="list-style-type: none"> <li>The optional user names are <b>Advanced User</b> and <b>Special User</b>. The initial password for <b>Advanced User</b> and <b>Special User</b> is <i>000001</i>. If you forgot the password, contact Huawei technical support for a dynamic password that is effective only on the current day. Change the password after login.</li> <li>After the authentication is successful, the system keeps the authentication information for 30 seconds. If you exit from the <b>Maintenance</b> screen and log in again within 30 seconds, no authentication is required.</li> </ul>
 <p>Maintenance</p> <p>USB Expansion</p> <p>Data Clear</p> <p>Alarm Reset</p> <p>System Reset</p>	<p>4. Choose <b>USB Expansion</b> and press .</p> <p><b>NOTE</b> If no USB flash drive is detected, the LCD displays a message prompting that a flash drive needs to be inserted.</p>

LCD	Procedure
<pre> Maintenance-&gt;USB Expansion   Firmware Upgrade     Config Import     Config Export     Data Export           </pre>	<p>5. Select a menu by pressing ▲ and ▼, and press ↵.</p> <p>The menu that can be selected are <b>Firmware Upgrade</b>, <b>Config Import</b>, <b>Config Export</b>, and <b>Data Export</b>.</p> <ul style="list-style-type: none"> <li>• To upgrade the firmware, perform step 6.</li> <li>• To import configurations, perform step 7.</li> <li>• To export configurations, perform step 8.</li> <li>• To export alarms, performance data, and log data, perform step 9.</li> </ul>
<pre> Maintenance-&gt;USB Expansion   Firmware Upgrade Current :V100R001C00SPC002 Target V :V100R001C00SPC003 ESC:Cancel          ↵:Enter           </pre>	<p>6. Confirm the target version and press ↵.</p> <p><b>NOTICE</b></p> <ul style="list-style-type: none"> <li>• Firmware upgrade is allowed only when the SUN2000 is properly connected to the PV strings (the PV connection indicator is green).</li> <li>• Before upgrading the firmware, download the upgrade package from <a href="http://support.huawei.com">http://support.huawei.com</a>, decompress the package, and copy the files to the root directory of the USB flash drive.</li> </ul>
<pre> Maintenance-&gt;USB Expansion   Config Import Import the config? ESC:Cancel          ↵:Enter           </pre>	<p>7. Press ↵.</p>
<pre> Maintenance-&gt;USB Expansion   Config Export   ██████████ 100%           ↵:Enter           </pre>	<p>8. After the configurations are successfully exported, press ↵.</p>

LCD	Procedure
	<p>9. After the data is successfully exported, press .</p>

----End

## 7.2.15 Cleaning the User Data

This topic describes how to clean the energy yield data and the historical alarms for the SUN2000. The energy yield data includes the daily energy yield (E-Day), monthly energy yield (E-Month), yearly energy yield (E-Year), historical energy yield (E-History), and total energy yield (E-Total).

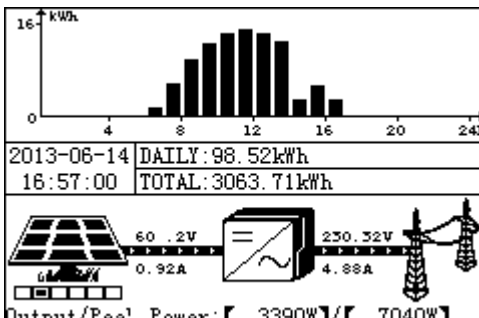

### Context

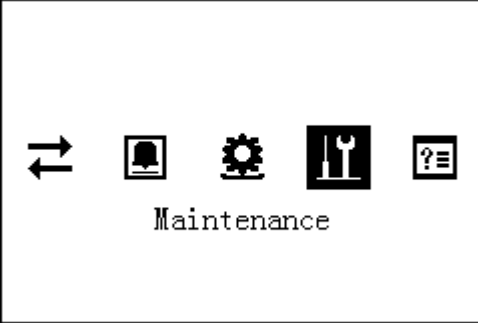


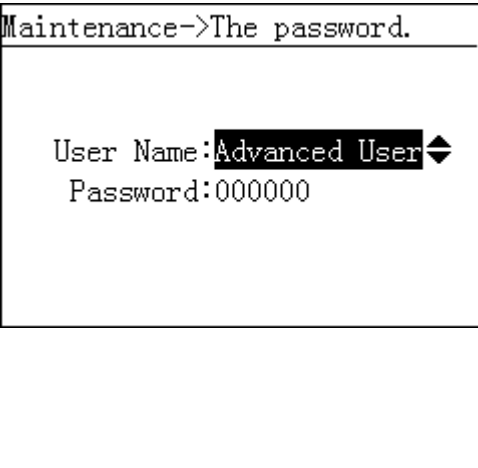




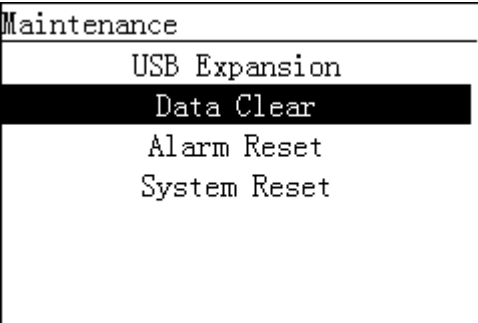

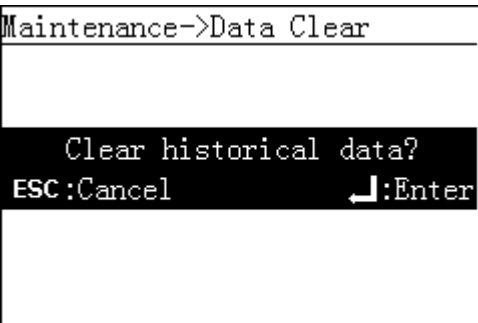


#### NOTICE

The operation of clearing user data is performed to delete the energy yield data and historical alarms during the commissioning phase. Data cannot be restored after being deleted. Therefore, exercise caution when deciding to perform this operation.

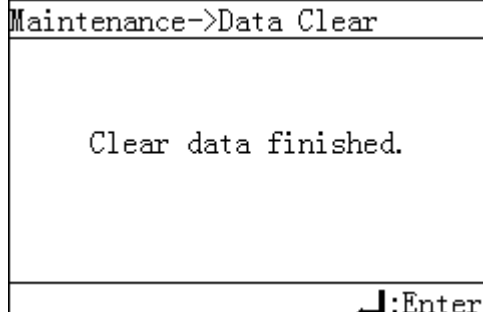

### Procedure

- The following table lists the procedure for cleaning user data. The parameter values in the figures are for reference only.

LCD	Procedure
	<p>1. On the default screen, press  to enter the main menu.</p>

LCD	Procedure
 <p>Maintenance</p>	<p>2. Choose  and press .</p>
<p>Maintenance-&gt;The password.</p>  <p>User Name: Advanced User  Password: 000000</p>	<p>3. Enter the correct user name and password by pressing  or , and press .</p> <p><b>NOTE</b></p> <ul style="list-style-type: none"> <li>The optional user names are <b>Advanced User</b> and <b>Special User</b>. The initial password for <b>Advanced User</b> and <b>Special User</b> is 000001. If you forgot the password, contact Huawei technical support for a dynamic password that is effective only on the current day. Change the password after login.</li> <li>After the authentication is successful, the system keeps the authentication information for 30 seconds. If you exit from the <b>Maintenance</b> screen and log in again within 30 seconds, no authentication is required.</li> </ul>
<p>Maintenance</p>  <p>USB Expansion Data Clear Alarm Reset System Reset</p>	<p>4. Choose <b>Data Clear</b> and press .</p>
<p>Maintenance-&gt;Data Clear</p>  <p>Clear historical data? ESC:Cancel :Enter</p>	<p>5. On the displayed screen, press .</p>



LCD	Procedure
	<p>6. Press  to finish the operation.</p>

----End

## 7.2.16 Resetting Alarms

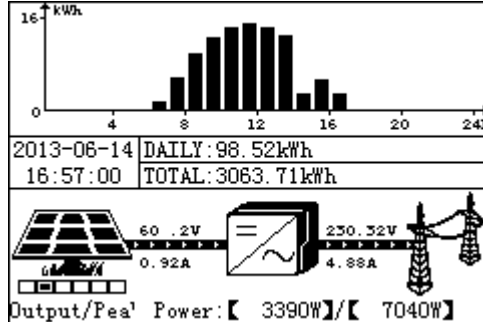

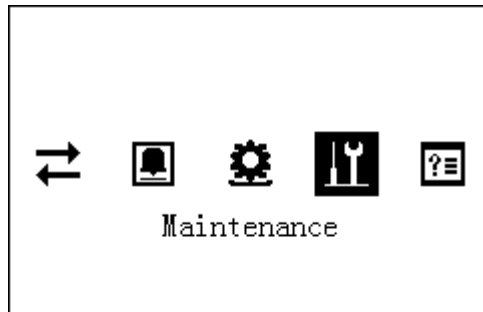


You can reset alarms on the LCD.

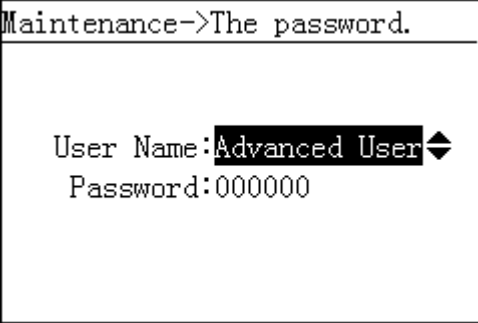
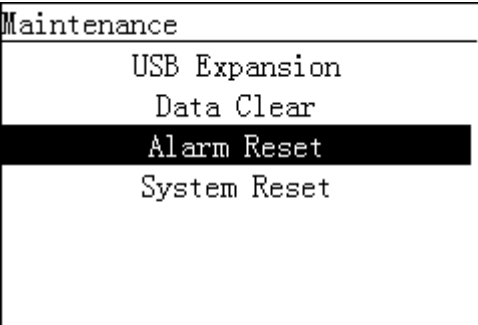
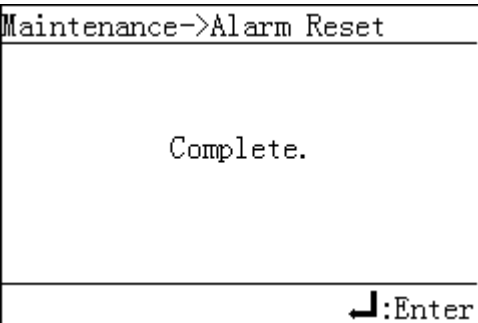
### Context

If you reset alarms on the LCD, all the active and historical alarms for the inverter are deleted and the SmartLogger starts to collect new alarms.

### Procedure

- The following table lists the procedure for resetting alarms. The parameter values in the figures are for reference only.

LCD	Procedure
	<p>1. On the default screen, press  to enter the main menu.</p>
	<p>2. Choose  and press .</p>

LCD	Procedure
	<p>3. Enter the correct user name and password by pressing ▲ or ▼, and press ↵.</p> <p><b>NOTE</b></p> <ul style="list-style-type: none"> <li>The optional user names are <b>Advanced User</b> and <b>Special User</b>. The initial password for <b>Advanced User</b> and <b>Special User</b> is <i>000001</i>. If you forgot the password, contact Huawei technical support for a dynamic password that is effective only on the current day. Change the password after login.</li> <li>After the authentication is successful, the system keeps the authentication information for 30 seconds. If you exit from the <b>Maintenance</b> screen and log in again within 30 seconds, no authentication is required.</li> </ul>
	<p>4. Choose <b>Alarm Reset</b>, and press ↵.</p>
	<p>5. After alarms are reset, press ↵.</p>

----End

## 7.2.17 Resetting the System

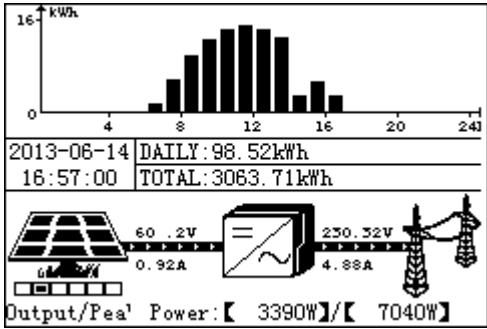

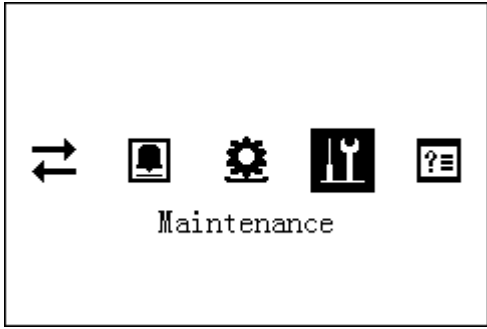


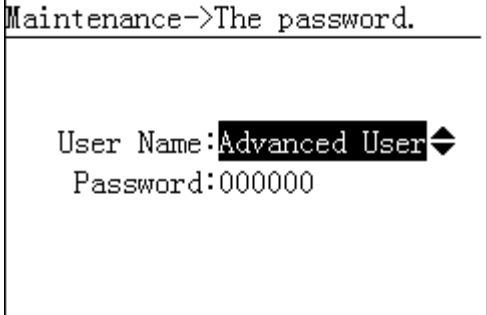



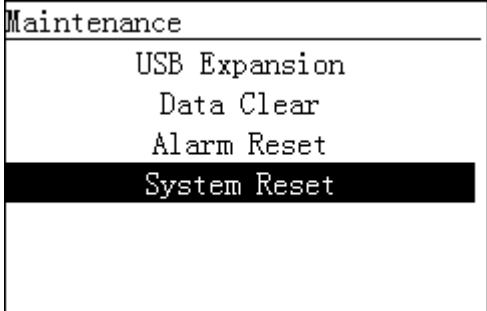

You can reset the system on the LCD.

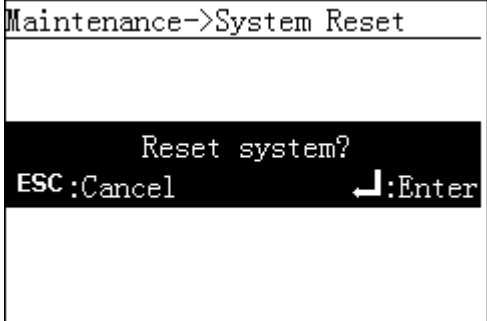
### Context

The inverter automatically shuts down and restarts after a system reset.

## Procedure

- The following table lists the procedure for resetting the system. The parameter values in the figures are for reference only.

LCD	Procedure
	<p>1. On the default screen, press  to enter the main menu.</p>
	<p>2. Choose  and press .</p>
<p>Maintenance-&gt;The password.</p> 	<p>3. Enter the correct user name and password by pressing  or , and press .</p> <p><b>NOTE</b></p> <ul style="list-style-type: none"> <li>The optional user names are <b>Advanced User</b> and <b>Special User</b>. The initial password for <b>Advanced User</b> and <b>Special User</b> is <b>000001</b>. If you forgot the password, contact Huawei technical support for a dynamic password that is effective only on the current day. Change the password after login.</li> <li>After the authentication is successful, the system keeps the authentication information for 30 seconds. If you exit from the <b>Maintenance</b> screen and log in again within 30 seconds, no authentication is required.</li> </ul>
	<p>4. Choose <b>System Reset</b>, and press .</p>

LCD	Procedure
	<p>5. After the system is reset, press ↵.</p>

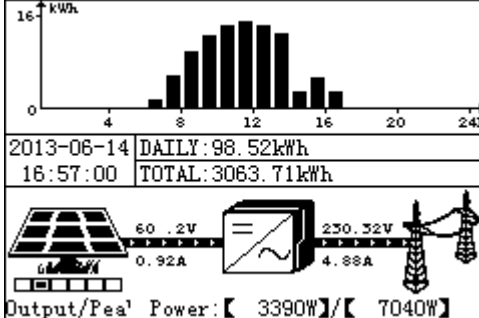
----End

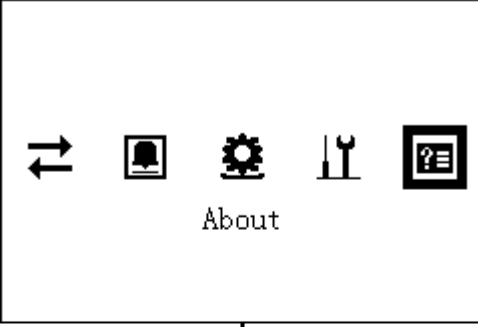
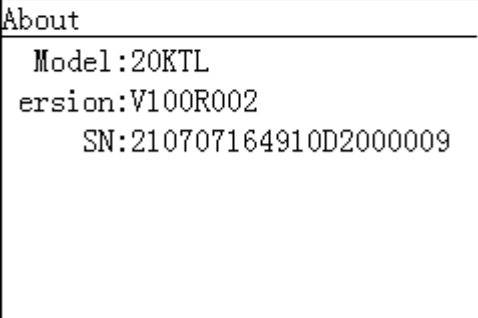


## 7.2.18 Viewing the System Version

This topic describes how to view the SUN2000 version on the monitoring panel.

### Procedure

- The following table lists the procedure for viewing the SUN2000 version information. The parameter values in the figures are for reference only.

LCD	Procedure
	<p>1. On the default screen, press ↵ to enter the main menu.</p>

LCD	Procedure
 <p>The LCD screen displays a row of five icons: a left-right arrow, a speech bubble, a gear, a wrench, and a help icon (a square with a question mark and three horizontal lines). Below these icons is the text 'About'. A downward arrow points from the 'About' text to the next screen.</p>  <p>The LCD screen displays the text 'About' at the top. Below it, the following information is shown: Model:20KTL ersion:V100R002 SN:210707164910D2000009</p>	<p>2. Choose  and press .</p> <p>The version information includes <b>Model</b>, <b>Version</b>, and <b>SN</b>.</p>

----End

# 8 Maintenance

This chapter describes routine maintenance and troubleshooting practices that ensure optimal performance of the SUN2000.

## 8.1 Powering Off the SUN2000

Comply with the safety precautions and operation procedures specified in this section when powering off the SUN2000 for maintenance or replacement.

### Context



#### WARNING

After the SUN2000 has shut down, residual electricity and heat may still cause electrical shock and body burns. Therefore, only begin servicing the SUN2000 five minutes later after shutting down.

---

### Procedure

- To maintain the SUN2000, perform [a](#) to [c](#). To replace the SUN2000, perform [a](#) to [g](#).
  - a. Enter the shutdown command on the LCD.  
For details, see [7.2.12 Manually Starting and Shutting down the SUN2000](#).  
A shutdown command can also be run from the element management system (EMS).  
For details, see the *NetEco 1000S V100R002C00 User Manual*.
  - b. Switch off the circuit breaker between the SUN2000 and the power grid.
  - c. Set the DC SWITCH to OFF.
  - d. Disconnect the RS485 communications cables.
  - e. Disconnect the DC input power cables.  
For details, see **Follow-up Procedure** in [5.3 Connecting DC Input Power Cables](#).
  - f. Disconnect the AC output power cables.  
For details, see **Follow-up Procedure** in [5.2 Connecting AC Output Power Cables](#).

- g. Disconnect the PGND cables.

For details, see **Follow-up Procedure** in [5.1 Connecting PGND Cables](#).

----End

## 8.2 Routine Maintenance

To ensure that the SUN2000 can operate properly for a long term, you are advised to perform routine maintenance on it as described in this chapter.



### CAUTION

- Before cleaning the system, and maintaining the cable connections and grounding reliability, power off the system (see [8.1 Powering Off the SUN2000](#)) and ensure that the DC SWITCH on the inverter is OFF.
- Before wiping the heat sink clean, switch off the circuit breaker between the SUN2000 and the power grid, set the DC SWITCH to OFF, and wait at least 5 minutes after the SUN2000 is powered off.

**Table 8-1** Maintenance list

Check Item	Check Method	Maintenance Interval
System cleaning	Check periodically that the heat sinks are free from obstacles or dust.	Semiannually to annually.
System running status	<ul style="list-style-type: none"> <li>• Check that the SUN2000 is not damaged or deformed.</li> <li>• Check for normal sound emitted during operation of the SUN2000.</li> <li>• Check that all SUN2000 parameter settings are correctly set during operation.</li> </ul>	Semiannually.
Electrical Connections	<ul style="list-style-type: none"> <li>• Check that cables are securely connected.</li> <li>• Check that cables are intact and the parts in contact with a metallic surface are not scratched.</li> <li>• Check that the idle RS485 and USB ports are covered by waterproof caps.</li> </ul>	Half a year after the initial commissioning, and semiannually to annually afterwards.
Grounding reliability	Check that PGND cables are securely connected.	Half a year after the initial commissioning, and semiannually to annually afterwards.

## 8.3 Troubleshooting

This section describes troubleshooting measures for common fault alarms in the SUN2000.

Alarms range in severity according to the following definitions:

- Major: The fault causes the SUN2000 to enter the shutdown mode and stop feeding electricity to the power grid.
- Minor: Some components are faulty but the SUN2000 can still feed electricity to the power grid.
- Warning: The SUN2000 output power decreases due to external factors.

Table 8-2 lists the measures taken to rectify common fault alarms in the SUN2000.

**Table 8-2** Troubleshooting

Alarm ID	Name	Severity	Causes	Measures
103	DC Over Voltage	Major	Too many PV modules connected in series lead to excessively high PV string output voltage, making the PV string open-circuit voltage greater than the maximum operating voltage of the SUN2000.	Check whether too many PV modules are connected in series, making the PV string open-circuit voltage greater than the maximum operating voltage of the SUN2000. If so, reduce the number of PV modules connected in series until the PV string output voltage drops to the specified range for the SUN2000. After the adjustment, the SUN2000 will work properly.
106 to 111	String 1-6 Abnormal	Warning	<ul style="list-style-type: none"> <li>• PV strings have been shielded for a long time.</li> <li>• PV strings have deteriorated.</li> </ul>	<ol style="list-style-type: none"> <li>Check whether the output current of a PV string is obviously less than the output current of other PV strings.</li> <li>If so, check whether the PV string is shielded.</li> <li>If the PV string is clean of contaminants and not shielded, check whether the PV modules are faulty.</li> </ol>
120 to 125	String 1-6 Reverse	Warning	The cables between PV strings were connected in reverse during SUN2000 installation.	Check whether the cables between PV strings are correctly connected. If they are connected in reverse, reconnect the cables.



Alarm ID	Name	Severity	Causes	Measures
200	DC Bus Voltage Fault	Major	<p>Abnormal external conditions have triggered DC circuit protection inside the SUN2000. The possible causes are as follows:</p> <ul style="list-style-type: none"> <li>• Reason ID = 3 The SUN2000 input is suddenly disconnected, or the shielded PV strings result in a sharp change in output power.</li> <li>• Reason ID = 9 or 11 The input energy of the SUN2000 cannot be vented quickly due to the sharp change of grid voltage. As a result, the internal voltage increases.</li> <li>• Reason ID = 10 The internal control circuit of the SUN2000 is unable to keep up with changes due to grid phase imbalances.</li> </ul>	<ol style="list-style-type: none"> <li>a. The SUN2000 monitors its external working conditions in real time and automatically reverts to normal operating status after the fault is rectified.</li> <li>b. If the alarm occurs repeatedly, contact Huawei technical support.</li> </ol>

Alarm ID	Name	Severity	Causes	Measures
202	Invert Module Fault	Major	<p>Abnormal external conditions have triggered converter circuit protection inside the SUN2000. The possible causes are as follows:</p> <ul style="list-style-type: none"> <li>• Reason ID = 4 A sharp drop in grid voltage or a short-circuit has occurred, resulting in high output current from the SUN2000.</li> <li>• Reason ID = 13 A sharp drop in grid voltage or a short-circuit has occurred, resulting in a fault in the voltage check circuit of the SUN2000.</li> <li>• Reason ID = 14 A sharp drop in grid voltage or a short-circuit has occurred, resulting in instantaneous high output current from the SUN2000.</li> <li>• Reason ID = 16 The grid DC current exceeds the allowed range.</li> <li>• Reason ID = 17 The grid voltage or frequency is abnormal.</li> <li>• Reason ID = 20 The SUN2000 output short-circuits, leading to a sharp increase in output current.</li> </ul>	<p>Reason ID = 4, 13, 14, 16, or 17</p> <ol style="list-style-type: none"> <li>a. The SUN2000 monitors its external working conditions in real time and automatically reverts to normal operating status after the fault is rectified.</li> <li>b. If the alarm occurs repeatedly, contact Huawei technical support.</li> </ol> <p>Reason ID = 20</p> <ol style="list-style-type: none"> <li>a. Check whether the SUN2000 output cables are short-circuited. Rectify any fault.</li> <li>b. If the alarm occurs repeatedly, contact Huawei technical support.</li> </ol>

Alarm ID	Name	Severity	Causes	Measures
301	Grid Voltage Abnormal	Major	<p>The grid voltage is beyond the allowed range. The possible causes are as follows:</p> <ul style="list-style-type: none"> <li>• Reason ID = 1 to 6 The grid A, B, or C phase voltage is less than the allowed range.</li> <li>• Reason ID = 13 to 18 The grid A, B, or C phase voltage is higher than the allowed range.</li> <li>• Reason ID = 26 The grid voltage is higher than the allowed range.</li> <li>• Reason ID = 27 or 28 There is large difference in grid voltage among the three phases.</li> <li>• Reason ID = 29 The grid has a power outage, or the AC line or the AC circuit breaker is disconnected.</li> </ul>	<p>Reason ID = 1 to 6</p> <ol style="list-style-type: none"> <li>a. If the alarm occurs accidentally, it is possible that there is an accidental grid abnormality. The SUN2000 automatically reverts to normal operating status after the fault is rectified.</li> <li>b. If the alarm occurs repeatedly, check whether the grid voltage is within the allowed range. If so, change the grid overvoltage and undervoltage protection points after obtaining approval from the local power operator. For details about how to change the protection points, see <a href="#">7.2.9 Setting Protection Parameters</a>. If the grid voltage is not within the allowed range, contact the local power operator.</li> <li>c. If the alarm persists for a long time, check that the AC circuit breaker and output cables of the SUN2000 are properly connected.</li> </ol> <p>Reason ID = 13 to 18, or 26</p> <ol style="list-style-type: none"> <li>a. Check whether the grid-tied point voltage is too high. If it is, contact your local power operator.</li> <li>b. If the grid-tied point voltage is higher than the allowed range, change the overvoltage and undervoltage protection points after obtaining approval from the local power operator.</li> <li>c. Check whether the grid voltage peak is too high.</li> </ol> <p>Reason ID = 27 or 28</p> <ol style="list-style-type: none"> <li>a. The SUN2000 monitors its external working conditions in real time and automatically reverts to normal operating status after the fault is rectified.</li> <li>b. If the alarm occurs repeatedly and affects the normal power generation of the power station, contact the local power operator.</li> </ol> <p>Reason ID = 29</p> <ol style="list-style-type: none"> <li>a. Check whether the AC voltage is normal.</li> <li>b. Check whether the AC line or circuit breaker is disconnected.</li> </ol>
Issue 10 (2017-07-30)			Huawei Proprietary and Confidential	116

Alarm ID	Name	Severity	Causes	Measures
305	Frequency Abnormal	Major	The actual frequency of the grid is higher than or lower than the required value for the local grid.	<p>a. If the alarm occurs accidentally, it is possible that there is an accidental grid abnormality. The SUN2000 automatically reverts to normal operating status after the fault is rectified.</p> <p>b. If the alarm occurs repeatedly, check whether the grid frequency is within the allowed range. If yes, change the grid overfrequency and underfrequency protection points after obtaining approval from the local power operator. For details about how to change the protection points, see <a href="#">7.2.9 Setting Protection Parameters</a>. If the grid frequency is not within the allowed range, contact the local power operator.</p>
313	Low Array Insulation Resistance	Major	<p>The insulation resistance against ground of the PV strings is low. The possible causes are as follows:</p> <ul style="list-style-type: none"> <li>• There is a short circuit between PV strings and the ground.</li> <li>• The PV strings are installed in a permanently moist environment.</li> </ul>	<p>a. Check the insulation resistance against the ground of the PV strings. If there is a short circuit, rectify the fault.</p> <p>b. If the insulation resistance against the ground is less than the default value in a rainy environment, set the ISO value. For details, see <a href="#">7.2.9 Setting Protection Parameters</a>.</p>
318	Residual Current Abnormal	Major	The insulation resistance against ground of the input side of the SUN2000 decreases during operation, which causes excessively high residual current.	<p>a. If the alarm occurs accidentally, it is possible that there is an accidental external circuit abnormality. The SUN2000 automatically reverts to normal operating status after the fault is rectified.</p> <p>b. If the alarm occurs repeatedly or lasts a long time, check whether the insulation resistance against ground of PV strings is too low.</p>
321	Cabinet Over-Temp	Major	<ul style="list-style-type: none"> <li>• The SUN2000 is installed in a place with poor ventilation.</li> <li>• The ambient temperature is too high.</li> <li>• The internal fan is not working.</li> </ul>	Check whether the ambient temperature for the SUN2000 exceeds the upper limit. If so, improve ventilation to decrease the temperature.

Alarm ID	Name	Severity	Causes	Measures
326	Electrical Grounding Fault	Major	<ul style="list-style-type: none"> <li>The neutral wire or PGND cable is not connected to the SUN2000.</li> <li>The isolation transformer is not connected to the SUN2000 at the output side when the PV strings are grounded.</li> </ul>	<ol style="list-style-type: none"> <li>Check that the neutral wire and PGND cable are properly connected.</li> <li>Check that an isolation transformer is connected to the SUN2000 at the output side when the PV strings are grounded.</li> </ol>
400	System Fault	Major	An unrecoverable fault has occurred on a circuit inside the SUN2000.	Flip the DC SWITCH on the SUN2000 to OFF, wait 5 minutes, and flip the DC SWITCH to ON. Check whether the fault is rectified. If the fault persists, contact Huawei technical support.
502	Internal Communication Fault	Minor	<ul style="list-style-type: none"> <li>The communication circuit of the SUN2000 is interrupted.</li> <li>The communication circuit is damaged.</li> <li>The internal communication address is incorrectly set.</li> </ul>	<ol style="list-style-type: none"> <li>If the fault is caused by a short circuit of the communication circuit inside the SUN2000, the SUN2000 automatically reverts to normal operating status after the fault is rectified.</li> <li>If the fault persists for a long time, contact Huawei technical support.</li> </ol>
504	Version Mismatch	Minor	The version of the software loaded during a software upgrade is incorrect.	Check whether a recent software upgrade has been performed. If so, upgrade the software again to the correct version.
505	Firmware Upgrade Failed	Major	The upgrade is incomplete.	Upgrade again.
61440	Flash Fault	Minor	<ul style="list-style-type: none"> <li>There is insufficient space on the flash drive.</li> <li>The flash drive has bad blocks or is faulty.</li> </ul>	<ol style="list-style-type: none"> <li>Replace the monitoring board.</li> <li>If the monitoring board is built into the monitoring device, replace the monitoring device.</li> </ol>

 **NOTE**

If a fault cannot be rectified by the measures listed in [Table 8-2](#), contact Huawei technical support.

# 9 SUN2000 Handling

---

This chapter describes how to remove, pack, and dispose of the SUN2000.

## 9.1 SUN2000 Removal

This section describes how to remove the SUN2000.

Perform the following operations to remove the SUN2000:

1. Disconnect all cables from the SUN2000, including RS485 communications cables, DC input power cables, AC output power cables, and PGND cables.  
For details, see [8.1 Powering Off the SUN2000](#).
2. (Optional) Open the anti-theft lock at the bottom of the SUN2000.
3. Unmount the SUN2000 from the rear panel.
4. Unfasten the rear panel.

## 9.2 SUN2000 Packing

This section describes how to pack the SUN2000.

- If the original packing case is available, place the SUN2000 inside the packing case and seal it with adhesive tape.
- If the original packing case is unavailable, place the SUN2000 inside a suitable hard carton and seal it properly.

## 9.3 Disposing the SUN2000

This topic describes how to dispose the SUN2000.

If the SUN2000 service life has expired, dispose of the SUN2000 in accordance with local rules for disposal of electrical equipment waste.

# 10 Technical Specifications

## Efficiency

Technical Specifications	SUN2000-8KTL	SUN2000-10KTL	SUN2000-12KTL	SUN2000-15KTL	SUN2000-17KTL	SUN2000-20KTL	SUN2000-23KTL	SUN2000-28KTL
Maximum efficiency	98.5%			98.6%			98.7%	
European efficiency	98.0%			98.3%			98.4%	

## Input

Technical Specifications	SUN2000-8KTL	SUN2000-10KTL	SUN2000-12KTL	SUN2000-15KTL	SUN2000-17KTL	SUN2000-20KTL	SUN2000-23KTL	SUN2000-28KTL
Maximum input power	9000 W	11,400 W	13,500 W	17,000 W	19,100 W	22,500 W	23,600 W	28,200 W
Maximum input voltage	1000 V							
Maximum input current (per MPPT)	18 A							
Maximum short-circuit current (per MPPT)	25 A							
Maximum operating voltage	950 V							
Minimum operating/startup voltage	200 V/250 V							
Max. inverter backfeed current to PV array	0 A							
Full power MPPT voltage range	320–800 V		380–800 V	400–800 V		480–800 V		520–800 V
Maximum number of inputs	4			6				
Number of MPP trackers	2 <sup>a</sup>			3 <sup>b</sup>				



a: Two MPPT routes can work independently or work in parallel.

b: Three MPPT routes can work independently or work in parallel, or any two of the three MPPT routes can work in parallel.

## Output

Technical Specifications	SUN2000-8KTL	SUN2000-10KTL	SUN2000-12KTL	SUN2000-15KTL	SUN2000-17KTL	SUN2000-20KTL	SUN2000-23KTL	SUN2000-28KTL
Rated active power	8000 W	10,000 W	12,000 W	15,000 W	17,000 W	20,000 W	23,000 W	27,500 W
Maximum apparent power	8800 VA	11,000 VA	13,200 VA	16,500 VA	18,700 VA	22,000 VA	23,000 VA	27,500 VA
Maximum active power (cosφ = 1)	8800 W	11,000 W	13,200 W	16,500 W	18,700 W	22,000 W	23,000 W	27,500 W
Rated output voltage	220 V-230 V/380 V-400 V, 3W + N + PE							277 V/480 V, 3W+PE
Adapted grid frequency	50 Hz/60 Hz							
Maximum output current	13.4 A	17 A	20 A	25.2 A	28.5 A	33.5 A		
Power factor	0.8 leading ... 0.8 lagging							
Maximum total harmonic distortion (rated power)	< 3%							

## Protection

Technical Specifications	SUN2000-8KTL	SUN2000-10KTL	SUN2000-12KTL	SUN2000-15KTL	SUN2000-17KTL	SUN2000-20KTL	SUN2000-23KTL	SUN2000-28KTL
Input DC switch	Yes							
Anti-islanding protection	Yes							
Output overcurrent protection	Yes							
Input reverse polarity protection	Yes							
PV string fault detection	Yes							
DC surge protection	Type II							
AC surge protection	Type II							
Insulation resistance detection	Yes							
Residual current monitoring unit (RCMU)	Yes							

## Display and Communication

Technical Specifications	SUN2000-8KTL	SUN2000-10KTL	SUN2000-12KTL	SUN2000-15KTL	SUN2000-17KTL	SUN2000-20KTL	SUN2000-23KTL	SUN2000-28KTL
Display	Graphical LCD, LED, Bluetooth module+app, USB data cable+app							
RS485	Yes							

## General Data

Technical Specifications	SUN2000-8KTL	SUN2000-10KTL	SUN2000-12KTL	SUN2000-15KTL	SUN2000-17KTL	SUN2000-20KTL	SUN2000-23KTL	SUN2000-28KTL
Dimensions (W x H x D)	520 mm x 610 mm x 266 mm (including the mounting plate)							
Weight	About 41 kg (excluding the mounting plate)/About 42 kg (including the mounting plate)			About 49 kg (excluding the mounting plate)/About 50 kg (including the mounting plate)				
Operating temperature range	-25 °C to +60 °C							
Cooling	Natural convection							
Maximum operating altitude	3000 m							
Humidity	0%–100% RH							
Input terminal	Amphenol Helios H4							
Output terminal	Amphenol C16/3							
Ingress Protection Rating	IP65							
Protective class	Class I							
Degree of pollution	III							
Topology	Transformerless							

# **A** Acronyms and Abbreviations

---

## **A**

**ACDU**

AC Distribution Unit

## **E**

**EMC**

Electromagnetic Compatibility

**EMI**

Electromagnetic Interference

**EMS**

Element Management System

**ESD**

Electrostatic Discharge

## **L**

**LCD**

Liquid Crystal Display

**LED**

Light Emitting Diode

## **M**

**MPP**

Maximum Power Point

**MPPT**

Maximum Power Point Tracking

## **P**

**PE**

Protective Earthing

**PGND**

Protection Ground

**PV**

Photovoltaic

## **R**

**RCMU**

Residual current monitoring unit

**S**

**SPD**

Surge Protective Device

# B Power Grid Codes

Set the power grid code that applies to the country or region where the power station is located and the SUN2000 model.

Low-voltage power grid codes apply to SUN2000 models including the SUN2000-8KTL, 10KTL, 12KTL, 15KTL, 17KTL, 20KTL, and 23KTL. [Table B-1](#) describes the countries to which low-voltage power grid codes apply.

**Table B-1** Low-voltage power grid codes

No.	Power Grid Code	Country
1	NB/T 32004	China Golden Sun low-voltage power grid
2	UTE C 15-712-1(A)	France low-voltage power grid
3	UTE C 15-712-1(B)	Islands of France 230 V 50 Hz
4	UTE C 15-712-1(C)	Islands of France 230 V 60 Hz
5	VDE 0126-1-1-BU	Bulgaria low-voltage power grid
6	VDE 0126-1-1-GR(A)	Mainland of Greece low-voltage power grid
7	VDE 0126-1-1-GR(B)	Islands of Greece low-voltage power grid
8	BDEW-MV	Germany medium-voltage power grid (400 V AC)
9	VDE-AR-N-4105	Germany low-voltage power grid
10	G59-England	England 230 V power grid (I > 16 A)
11	G59-Scotland	Scotland 240 V power grid (I > 16 A)
12	G83-England	England 230 V power grid (I < 16 A)
13	G83-Scotland	Scotland 240 V power grid (I < 16 A)
14	EN50438-CZ	Czech Republic low-voltage power grid
15	RD1699	Spanish low-voltage power grid (Pn < 100 kW)
16	RD661	Spanish low-voltage power grid (Pn > 100 kW)

No.	Power Grid Code	Country
		kW)
17	EN50438-NL	Netherlands low-voltage power grid
18	C10/11	Belgium low-voltage power grid
19	AS4777	Australia low-voltage power grid
20	CEI0-16	Italian medium-voltage power grid
21	CEI0-21	Italian low-voltage power grid
22	ANRE	Romania low-voltage power grid
23	TAI-PEA	Thailand low-voltage power grid (PEA)
24	TAI-MEA	Thailand low-voltage power grid (MEA)
25	EN50438-TR	Turkey low-voltage power grid
26	Philippines	Philippines low-voltage power grid
27	NRS-097-2-1	South Africa low-voltage power grid
28	KOREA	South Korea low-voltage power grid
29	IEC61727	IEC low-voltage power grid (50 Hz)
30	IEC61727-60Hz	IEC low-voltage power grid (60 Hz)
31	Custom (50Hz)	Reserved
32	Custom (60Hz)	Reserved

Medium-voltage power grid codes apply to SUN2000 models including the SUN2000-28KTL. [Table B-2](#) describes the countries to which medium-voltage power grid codes apply.

**Table B-2** Medium-voltage power grid codes

No.	Power Grid Code	Country
1	CHINA-MV480	China medium-voltage power grid
2	BDEW-MV480	Germany medium-voltage power grid
3	G59-England-MV480	UK 480 V Medium-voltage power grid (I > 16 A)
4	UTE C 15-712-1-MV480	France medium-voltage power grid
5	TAI-PEA-MV480	Thailand medium-voltage power grid (PEA)
6	TAI-MEA-MV480	Thailand medium-voltage power grid (MEA)

No.	Power Grid Code	Country
7	EN50438-DK-MV480	Denmark medium-voltage power grid
8	Japan (50Hz)	Japan power grid (50 Hz)
9	Japan (60Hz)	Japan power grid (60 Hz)
10	EN50438-TR-MV480	Turkey medium-voltage power grid
11	C11/C10-MV480	Belgium medium-voltage power grid
12	Philippines-MV480	Philippines medium-voltage power grid
13	AS4777-MV480	Australia medium-voltage power grid
14	NRS-097-2-1-MV480	South Africa medium-voltage power grid
15	IEC61727-MV480	IEC medium-voltage power grid (50 Hz)
16	IEC61727-MV480-60Hz	IEC medium-voltage power grid (60 Hz)
17	ANRE-MV480	Romania medium-voltage power grid
18	Custom-MV480 (50Hz)	Reserved
19	Custom-MV480 (60Hz)	Reserved