

# SunMaster

## CS15TL RP / CS20TL RP / CS30TL RP

HIGH POWER GRID CONNECTED SOLAR INVERTER



UK | USERS AND INSTALLATION MANUAL | P01  
NL | GEBRUIKERS- EN INSTALLATIEHANDLEIDING | P45  
DE | BEDIENUNGS- UND INSTALLATIONSANLEITUNG | P93  
FR | MANUEL UTILISATEURS ET D'INSTALLATION | P141  
ES | MANUAL DEL USUARIO Y DE INSTALACIÓN | P189  
IT | MANUALE DI USO E MANUTENZIONE | P237

1000000186/04



**OVERVIEW CS15TL RP/ CS20TL RP/ CS30TL RP**

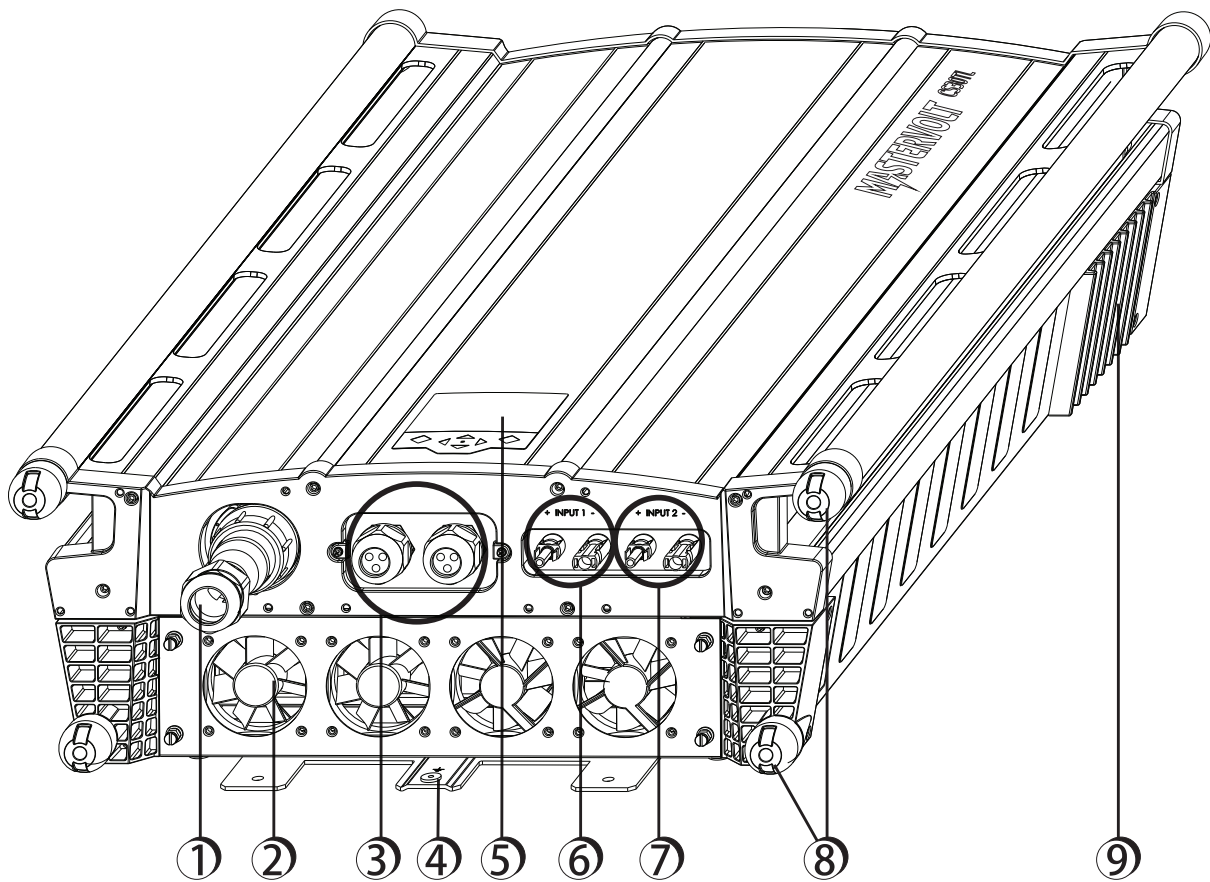

Figure 0-1: Overview of the SunMaster CS15TL RP / CS20TL RP / CS30TL RP

- |                                     |                  |
|-------------------------------------|------------------|
| 1. 3-phase 400V grid connection     | 6. Solar input 1 |
| 2. Fan module (air inlet)           | 7. Solar input 2 |
| 3. Communication module             | 8. Foot stands   |
| 4. External grounding (PE) facility | 9. Air outlets   |
| 5. Multi-language display           |                  |

**CONTENT**

1000000186/04 March 2013

<b>1</b>	<b>GENERAL INFORMATION</b>	<b>6</b>
1.1	PRODUCT DESCRIPTION	6
1.2	USE OF THIS MANUAL	6
1.3	VALIDITY OF THIS MANUAL	6
1.4	SCOPE OF GUARANTEE	6
1.5	LIABILITY	6
1.6	CHANGES TO THE INVERTER	6
1.7	IDENTIFICATION LABEL	6
<b>2</b>	<b>SAFETY GUIDELINES AND WARNINGS</b>	<b>7</b>
2.1	WARNINGS AND SYMBOLS	7
2.2	USE FOR INTENDED PURPOSE	7
2.3	INSTALLATION, MAINTENANCE, REPAIR	7
2.4	WARNING OF SPECIAL DANGERS	7
<b>3</b>	<b>HOW IT WORKS</b>	<b>8</b>
3.1	PV MODULE, STRING, ARRAY AND COMBINER BOX	8
3.2	GRID CONNECTED INVERTER	8
3.3	NON-ISOLATED (TRANSFORMERLESS)	8
3.4	GRID INTERFACE	8
3.5	DISPLAY AND MONITORING	9
3.6	INGRESS PROTECTION AND OPTIMA COOLING	9
3.7	ANTI ISLANDING	9
3.8	STABIGRID FUNCTION	9
3.9	REACTIVE POWER	9
<b>4</b>	<b>BEFORE YOU START</b>	<b>10</b>
4.1	TRANSPORT, LIFTING AND STORAGE	10
4.2	INSTALLATION ENVIRONMENT	10
4.3	DC INPUT SPECIFICATIONS	10
4.4	SOLAR ARRAY CAPACITANCE	11
4.5	AC OUTPUT SPECIFICATIONS	12
4.6	LIGHTNING PROTECTION	12
<b>5</b>	<b>GENERAL INSTALLATION AND COMMISSIONING</b>	<b>13</b>
5.1	THINGS YOU NEED FOR INSTALLATION	13
5.2	UNPACKING THE CS INVERTER	13
5.3	MOUNTING THE INVERTER	14
5.4	AC 3-PHASE CONNECTOR	14
5.6	CONNECTING AND COMMISSIONING	15
<b>6</b>	<b>OPERATION AND MAINTENANCE</b>	<b>16</b>
6.1	GENERAL	16
6.2	MAINTENANCE	16
6.3	DE-COMMISSIONING	16
<b>7</b>	<b>COMMUNICATION</b>	<b>17</b>
7.1	COMMUNICATION MODULE	17
7.2	MASTERBUS NETWORK	17
7.3	MASTERBUS CONNECTORS	17
7.4	RS485 CONNECTORS	18
7.5	REMOTE MONITORING WITH RS485	18
7.6	PLANT TOTALS	18
7.7	ALARM CONTACTS	18

<b>8</b>	<b>DISPLAY</b>	<b>19</b>
8.1	BUTTONS	19
8.2	THE HOME SCREEN	19
8.3	MAIN MENU	19
8.4	ENERGY TOTALS	19
8.5	PLANT TOTALS	20
8.6	MULTIMETER & STRINGMASTER	21
8.7	DATALOGGER	22
8.8	LOGBOOK	23
8.9	CONFIGURATION MENU	23
<b>9</b>	<b>SPECIFIC DC CONFIGURATIONS</b>	<b>28</b>
9.1	ISOLATION DETECTION	28
9.2	USING A STRINGMASTER PRO	28
9.3	DC SWITCH	28
<b>10</b>	<b>SPECIFIC AC CONFIGURATIONS</b>	<b>29</b>
10.1	SUPPORTED COUNTRIES	29
10.2	FUNCTION TEST FOR ITALIAN INSTALLATIONS	29
10.3	ACTIVE POWER MANAGEMENT	31
10.4	REACTIVE POWER EXPLANATION	32
10.5	REACTIVE POWER MANAGEMENT	32
10.6	USING AN ISOLATION TRANSFORMER	33
<b>11</b>	<b>FUNCTIONAL GROUNDING</b>	<b>35</b>
11.1	FUNCTIONAL GROUNDING	35
11.2	INSTALLATION REQUIREMENTS	35
11.3	INVERTER SETTINGS	35
11.4	MULTIPLE CS INVERTERS ON A SINGLE TRANSFORMER	35
<b>12</b>	<b>TROUBLE SHOOTING</b>	<b>36</b>
12.1	LED INDICATION AND SOLUTION TABLE	36
<b>13</b>	<b>TECHNICAL SPECIFICATIONS</b>	<b>37</b>
13.1	OUTLINE DRAWINGS	38
<b>14</b>	<b>ORDERING INFORMATION</b>	<b>39</b>
<b>15</b>	<b>CERTIFICATES</b>	<b>40</b>
15.1	VDE0126-1-1 CERTIFICATE OF COMPLIANCE	40
15.2	RD 1699 COMPLIANCE	41
15.3	ENEL CERTIFICATE	42
15.4	BDEW CERTIFICATE	43
15.5	EC DECLARATION OF CONFORMITY	44

## 1 GENERAL INFORMATION

### 1.1 PRODUCT DESCRIPTION

The SunMaster CS15TL, CS20TL and CS30TL, further referred to as “SunMaster CS” or “CS inverter” are grid connected solar inverters. This inverter type is used to convert photovoltaic power and feed this into a three phase grid. The CS inverter is not suitable for stand-alone use (i.e. use without utility grid).

### 1.2 USE OF THIS MANUAL

Copyright © 2013 Mastervolt. All rights reserved. Reproduction, transfer, distribution or storage of part or all of the contents in this document in any form without the prior written permission of Mastervolt is prohibited.

This manual serves as a guideline for the safe and effective use and installation of the SunMaster CS:

- For the installer this manual gives directions for the installation, operation and commissioning.
- For the end user, this manual gives directions for the operation, maintenance and possible correction of minor malfunctions of the CS inverter.
- Every person who works with the apparatus should be familiar with the contents of this manual, and must carefully follow the instructions contained herein.
- Store the manual in an accessible place.

### 1.3 VALIDITY OF THIS MANUAL

This manual is valid for the following models:

Part no Model

131210150 SunMaster CS15TL RP

131210200 SunMaster CS20TL RP

131210300 SunMaster CS30TL RP

All the specifications, provisions and instructions contained in this manual apply solely to the Mastervolt-delivered stand-alone version of the CS inverter.

### 1.4 SCOPE OF GUARANTEE

Mastervolt assures the product guarantee of the SunMaster CS during five years after your purchase, on the condition that all instructions and warnings given in this manual are taken into account during installation and operation.

Among other things, this means that installation is carried out by a qualified electrician, that installation and maintenance are executed according to the stated instructions and correct working sequence, and that no changes or repairs may have been performed on the CS inverter other than by Mastervolt.

The warranty is limited to the costs of repair and/or replacement of the product by Mastervolt only. Costs for installation labour or shipping of the defective parts are not covered by this warranty.

For making an appeal on warranty you can contact your supplier directly, stating your complaint, application, date of purchase and part number / serial number.

### 1.5 LIABILITY

Mastervolt accepts no liability for:

- consequential damage due to use of the SunMaster CS;
- possible errors in the manuals and the results thereof.

### 1.6 CHANGES TO THE INVERTER

Changes to the SunMaster CS hardware are not allowed. Changes to the SunMaster CS software/ firmware, except for the settings made available to the user or installer, are not allowed.

### 1.7 IDENTIFICATION LABEL

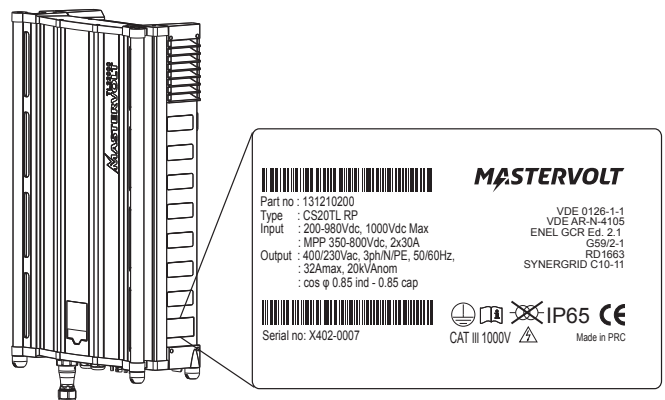

Figure 1-1

The identification label is positioned at the right side of the CS inverter, see figure 1-1.



### CAUTION!

Never remove the identification label.

## 2 SAFETY GUIDELINES AND WARNINGS

### 2.1 WARNINGS AND SYMBOLS

Safety instructions and warnings are marked in this manual by the following pictograms:



A procedure, circumstance, etc which deserves extra attention.



#### CAUTION!

Special information, commands and prohibitions in order to prevent damage.



#### WARNING

A WARNING refers to possible injury to the user or installer or significant material damage to the inverter if the installer / user does not (carefully) follow the stated procedures.

### 2.2 USE FOR INTENDED PURPOSE

The SunMaster CS is constructed as per the applicable safety-technical guidelines. Use the CS inverter only in installations that meet the following qualifications:

- in permanent installations;
- connected to a separate, grounded three phase AC group, to which no other electrical equipment is connected;
- the electrical installation must meet the applicable regulations and standards (must be carried out correctly) and must be in a good condition;
- according to the technical specifications as stated in section 10.1.



#### WARNING

Never use the SunMaster CS in situations where there is danger of gas or dust explosion or potentially flammable products!

Use of the inverter other than as mentioned under section 2.2 is considered to be conflicting with the intended purpose. In such cases, Mastervolt will not accept liability for any damage or injury caused by the functioning or malfunctioning of the inverter.

### 2.3 INSTALLATION, MAINTENANCE, REPAIR



#### WARNING

As dangerous voltages exist, only allow installation, maintenance and repair of the SunMaster CS to be carried out by qualified electricians.

Connections and safety features must be executed according to the locally applicable regulations.

In case of decommissioning and/or demounting follow the instructions as stated in section 6.3.

If repairs or replacements are required, only use original Mastervolt spare parts.

### 2.4 WARNING OF SPECIAL DANGERS



Two primary energy sources are present:

- solar panels (DC)
- utility grid (AC).

Switch off both sources before starting any work on the installation. Block the switching device against unintentional reconnection. Verify the de-energizing of both DC and AC connections using a suitable metering instrument.

The voltages present at the grid and solar side of the CS inverter are not safe to touch.

Make sure two persons are present when working on the installation, at least until the installation has been de-energized and verified by a suitable metering instrument.

### 3 HOW IT WORKS

The CS inverter is a grid connected photovoltaic power inverter. It converts the high voltage DC power coming from the photovoltaic (PV) panels into AC power. The AC voltage is fed back into the public utility grid.

A series of PV panels is called a string. One string can be connected to one solar input of the inverter.

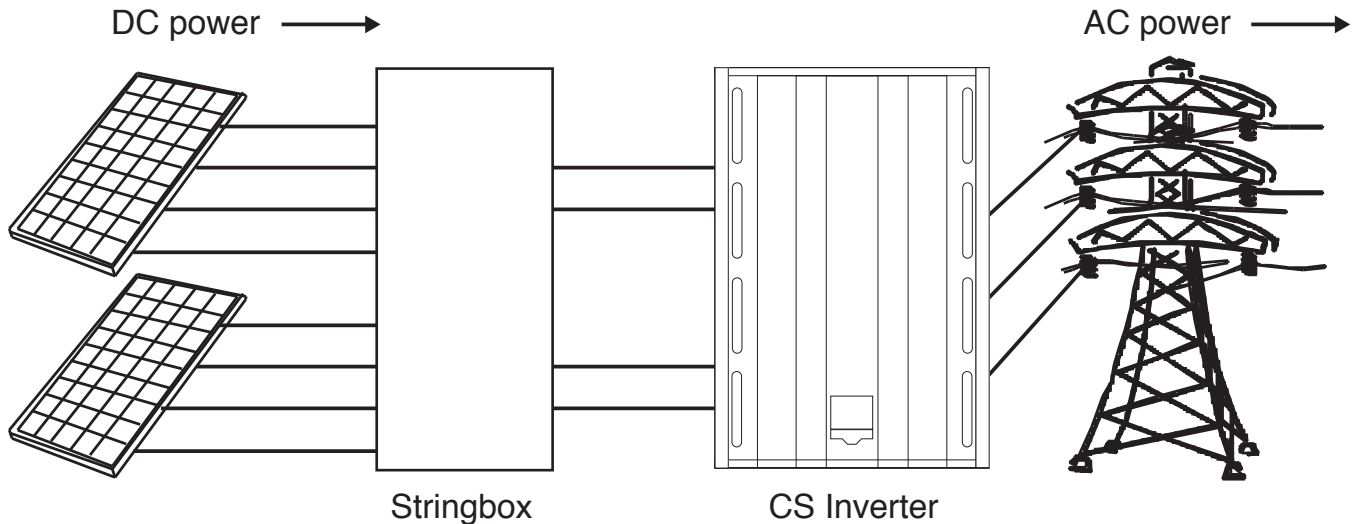

Figure 3-1: Schematic example of the CS inverter in a PV plant

#### 3.1 PV MODULE, STRING, ARRAY AND COMBINER BOX

PhotoVoltaic (PV) modules convert light into DC power. To reduce cable losses, PV modules are connected in series: a so-called “string”. A plane of PV modules is called a PV array and consists of multiple strings of the same length, being connected in parallel. PV strings can be paralleled in a string (combiner) box. These boxes may provide over current protection and/ or over voltage (surge) protection, DC isolating switch and string monitoring functionality.

#### 3.2 GRID CONNECTED INVERTER

See figure 3-1.

The SunMaster CS main task is to convert DC power produced by the PV modules into AC power and to feed it back into the public utility grid. The SunMaster CS is not suitable to be operated in stand-alone mode (independently from the utility grid). The SunMaster CS has two independent DC inputs. The PV arrays connected to these inputs are each operated at their optimum voltage for an optimal yield (MPP tracking).

#### 3.3 NON-ISOLATED (TRANSFORMERLESS)

The SunMaster CS is a non-isolated (transformerless) inverter. During operation, it couples the PV array potential to the utility grid. An optional isolating transformer is available for applications where galvanic isolation is required (functional grounding, see chapter 11).

#### 3.4 GRID INTERFACE

The DC PV input is inverted to an AC output: 230/400V AC (3-Ph/N/PE) output in Wye (Y) configuration. For the PV input operating voltage range refer to the specifications. Anti- islanding is provided according to national standards.

The grid interface contains numerous safety mechanisms to guarantee a level of safety better than an isolated inverter. Redundant relays isolate the inverter from the grid in case one of the following circuits detects a fault:

Isolation resistance detection: monitors PV array isolation resistance.

- RCMU (residual current monitoring unit): monitors and protects against ground leakage currents.
- DC injection: Monitors DC current injection into the grid.
- Grid voltage- and frequency monitoring
- Anti islanding protection: loss of utility detection
- Low voltage ride through
- Reactive Power



### 3.5 DISPLAY AND MONITORING

#### 3.5.1 CS inverter display

The CS inverter is equipped with a multi language display for on site monitoring and control. Refer to chapter 8 Display for details.

#### 3.5.2 Remote monitoring via RS485

The SunMaster CS supports RS485. This bus facilitates remote monitoring via the RS485 network using a DataControl datalogger. Monitoring can be accomplished via internet or via a telephone connection. See also section 7.4. If you opt for remote Monitoring & Control, please contact your Mastervolt supplier.

#### 3.5.3 Remote monitoring and control via MasterBus

The CS inverter can communicate with an optional StringMaster and isolation transformer via the MasterBus network.

### 3.6 INGRESS PROTECTION AND OPTIMA COOLING

The SunMaster CS consists of two separate compartments. Rubber seals provide IP65 protection of the power electronics against ingress of dust and humidity. The cooling compartment provides IP44 protection and contains only components resistant to dust and humidity. By keeping the inverter cool, the intelligent Optima Cooling algorithm helps to reduce losses and extend inverter life.

### 3.7 ANTI ISLANDING

The SunMaster CS is equipped with an anti-islanding system that ensures instant disconnection in case of grid failure. European countries maintain different regulations with regard to anti-islanding devices and grid connection of distributed generation in general. The common islanding device switches off the inverter if the grid voltage or frequency is out of range. The CS inverter is set to local regulations by setting the country in the configurations menu. This setting is password protected. The password is available for installers on request.



#### CAUTION!

NEVER connect the CS inverter to a utility grid other than specified, refer to section 4.5.

### 3.8 STABIGRID FUNCTION

SunMaster CS inverters have a high level of immunity to voltage fluctuations caused by industrial loads. The inverter stays online in case of minor grid fluctuations, thereby supporting the utility network and increasing the daily energy yield.

### 3.9 REACTIVE POWER

As per January 1st 2012, PV installations in Germany capable of generating more than 3,68 kVA will be required to provide reactive power.

Reactive power is used by the utility operators to control the voltages in the power grid. As the share of power generated by PV installations grows every year, it becomes increasingly important for PV plants to support the grid similar to conventional power plants.

The SunMaster CS “RP” version has been developed to meet the new requirements according to the new VDE-AR-4105 norm. The specific features required in this norm will

automatically be enabled when the installation country “Germany” is selected:

- Active Power Derating; which can be self-controlled by the inverter depending on the grid frequency, or set by the grid operator via telecommand.
- Reactive Power Provision; which can be self controlled by the inverter, depending on different variables (grid voltage or inverter output power)

Active grid support functions limit the capacity of active power and therefore should be taken into account when designing a PV system. Mastervolt provides a “SysCalc” design tool to assist customers with system design work. It is available for free on [www.mastervoltsolar.com](http://www.mastervoltsolar.com). Refer to section 10.4 for more information on Reactive Power.

## 4 BEFORE YOU START

### 4.1 TRANSPORT, LIFTING AND STORAGE



Ensure adequate and secure packaging during transportation of the CS inverter. Always use suitable handling equipment for transportation. More than two persons may be required to hang the CS inverter to a wall, refer to local safety standards.

The CS inverter is shipped in a wooden crate that can be handled with a fork lift. In order to prevent damage, always transport the CS inverter in its transportation crate. Minimum two persons are required to unpack the CS inverter and to lift it out of its box.

### 4.2 INSTALLATION ENVIRONMENT

The CS inverter is designed for both indoor and outdoor use, protection degree is IP65.

Operating conditions:

- -20 to 60°C, relative humidity 4% to 100% condensing.
- Power derating at temperatures above 45 °C.
- Start-up at temperatures above -10 °C



**CAUTION!**

Do not install in aggressive environments like ammonium, acids and salt air.



**CAUTION!**

Do not install in areas that are subject to the risk of gas- or dust explosions.

#### 4.2.1 For all installations

- If the CS inverter is installed in the immediate vicinity of living areas, take into account that it can produce a certain noise level when operating.
- Hang the CS vertically to a sufficiently strong, solid wall, no other angle other than straight up is allowed.
- Keeping at least 50 cm space around the CS inverter is recommended, see fig. 4-1.

#### 4.2.2 For indoor installations

- Maintain sufficient ventilation and enough distance around each inverter to prevent build up of hot air.

#### 4.2.3 For outdoor installations

- Prevent placement in direct sunlight as this warms up the inverter, resulting in performance loss.
- Shield the inverter against direct rain when possible to avoid corrosion.
- In humid atmospheres with large temperature differences, moisture may gather behind the display screen. If this persists, contact your Mastervolt supplier.

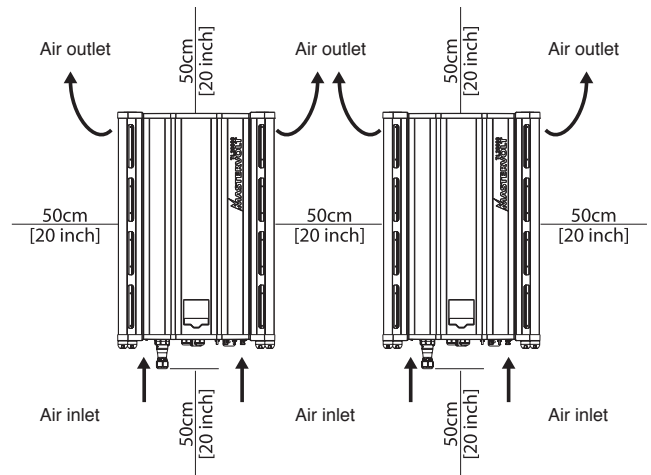

Figure 4-1: Mounting distance

### 4.3 DC INPUT SPECIFICATIONS

The PV installation to which the inverter is connected should meet the following input specifications.

DC Input specifications per input			
Model	CS15TL RP	CS20TL RP	CS30TLRP
Absolute max. Input Voltage	1000VDC	1000VDC	1000VDC
Operating voltage	200VDC – 980VDC		
Full power voltage	350VDC – 800VDC	350VDC – 800VDC	460VDC – 800VDC
Max. input current	23ADC	30ADC	34ADC
Maximum PV power	9,5 kWp	12,5 kWp	19,0 kWp
Recommended PV power	9,0 kWp	11,5 kWp	17,5 kWp
Maximum array capacitance	6 µF total for 2 inputs		
Max. PV I <sub>sc</sub>	30A	30A	34A



Never connect voltages higher than 1000V DC to the inverter, as this will cause permanent damage to the inverter.



The inverter will automatically limit the input current and power to its specified rating. Excess power will not be converted.

**4.3.1 Recommended cabling**

All devices within the PV installation (panels, wiring, terminal blocks, fuse holders, fuses, switches, etc.) must be rated for the applicable maximum voltage and current ratings. Use double isolated DC cabling for all connections. A sufficiently large copper cross section will help reducing the cable losses.

Current Length	10ADC	20 ADC	30ADC
<10 m	2.5 mm <sup>2</sup>	4.0 mm <sup>2</sup>	6.0 mm <sup>2</sup>
10-20 m	4.0 mm <sup>2</sup>	6.0 mm <sup>2</sup>	10 mm <sup>2</sup> *
>20 m	>4.0 mm <sup>2</sup>	>6.0 mm <sup>2</sup> *	>10 mm <sup>2</sup> *

\*Cable adapter may be necessary for cross sections >6.0 mm<sup>2</sup>

**4.3.2 DC Connectors and switch**

The SunMaster CS inverters use MC4 compatible DC connectors with a 4 mm pin diameter.



Do not reverse the polarity of the PV connections. The inverter will be permanently damaged, and large short-circuit currents may occur.

For safety reasons, the use of a suitable DC switch between the PV modules and the inverter is recommended. Depending on locally applicable regulations, such a switch may be mandatory.

**4.3.3 Parallel or independent operation**

The SunMaster CS has two independently controlled inputs, labelled "Input 1" and "Input 2". These inputs can be used as separate inputs or they can be connected in parallel depending on the PV installation. The inverter will automatically detect if the inputs have been paralleled. Make sure to divide the PV power over the two inputs as equally as possible.

Parallel operation	Independent operation
For uneven number of strings in the array.	Per input different array configuration or orientation possible.
Required when applying functional grounding.	Reduce losses in case of local shadowing.
Refer to chapter 11.	

To accommodate more than 1 PV string on each input, a DC combiner box such as StringMaster should be used. Refer to the StringMaster manual for specific installation instructions. When more than three strings are paralleled in an array, they must be fused. Use only DC rated fuses with appropriate voltage and current ratings.

To avoid excessive losses, always make sure the string voltages are equal to each other before paralleling them. Never use different string lengths or different module types in the same array.

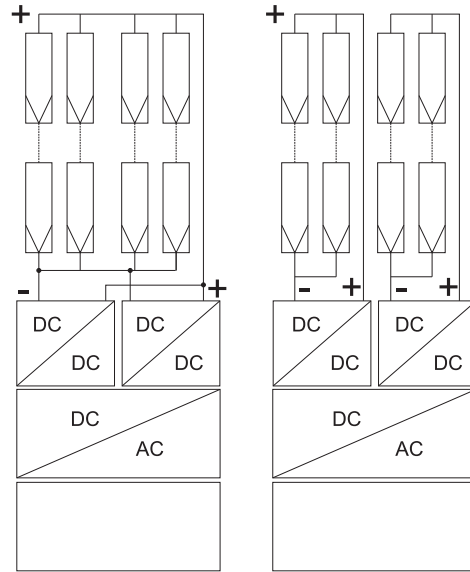

Figure 4-2: Parallel and independent operation

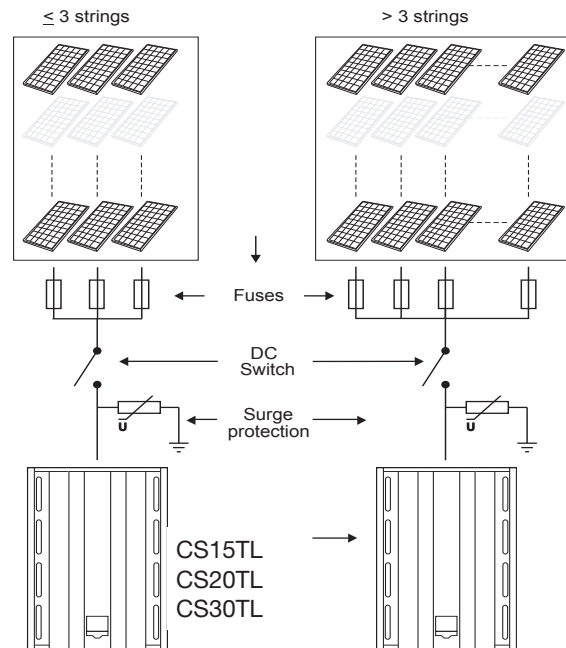

Figure 4-3: Functional scheme StringMaster

**4.4 SOLAR ARRAY CAPACITANCE**

Every solar panel has a small parasitic (virtual) capacitance between the photo-sensitive material and the external structure. In the PV array all these capacitances add up to one larger (virtual) capacitance.

If this capacitance is too large, it causes a high leakage current to flow from the main electrical path to the external structure. Such currents can be dangerous to humans and may further degrade the performance of the installation.

The SunMaster CS is designed to operate with a solar array capacitance up to 6 µF. Larger array capacitances may cause too large leakage currents, and can trip the internal RCD protection.

If the RCD trips because of large PV array capacitance, installing an isolation transformer may be necessary. Consult your Mastervolt distributor for assistance.

**4.5 AC OUTPUT SPECIFICATIONS**

The SunMaster CS is intended for use in a permanent installation, connected to a separately fused three-phase AC branch to which no other equipment is connected. All electrical connections must comply with locally applicable installation codes and regulations.

The CS inverter is designed to operate in the following grid conditions:

AC specifications			
Model	CS15TL RP	CS20TL RP	CS30TL RP
Nominal Power	15.000VA	20.000VA	30.000VA
Maximum Power	15.750VA	21.000VA	31.500VA
AC Voltage	3 Phase - 4 Wire Y UGRID = 230VRMS +20%/-20%		
Max. Phase Current	3 x 24,2 ARMS	3 x 32,2 ARMS	3 x 46 ARMS
Max. Neutral Current	<1 ARMS		
AC Frequency (50Hz)	45Hz – 55Hz		
AC Frequency (60Hz)	55Hz – 65Hz		
Max. Inrush Current	28.2A		
Short circuit L-N	150A peak/12.9A RMS(3 cycl) during 8ms		
Short circuit L-L	298A peak/21.8A RMS (3 cycl) during 4ms		

**4.5.1 Fusing**

The SunMaster CS does not have internal fuses. External fuses or circuit breakers are mandatory on every phase according to the following ratings:

AC fuses			
Model	CS15TL RP	CS20TL RP	CS30TL RP
Fuse B Characteristic	32A	40A	63A

Not installing a properly rated fuse (Icu > 2.1 kA) will pose a safety hazard and will void the warranty of the inverter.

**4.5.2 Wiring**

The AC output is arranged in a 230/400V AC (3-Ph/N/PE) Wye configuration. The neutral connection does not carry any current, but must be connected to the inverter. The PE connection must have a cross section as large as the largest line conductor used, with a minimum of 4 mm<sup>2</sup>. For easy installation, using a flexible cable type is recommended. Refer to the locally applicable installation codes and regulations for cable sizing.

AC wiring			
Model	CS15TL RP	CS20TL RP	CS30TL RP
Minimum cable cross section	4 mm <sup>2</sup>	6 mm <sup>2</sup>	10 mm <sup>2</sup>
Maximum AC connector capacity	10 mm <sup>2</sup>		16 mm <sup>2</sup>
Flexible cable outer diameter	20 mm		25 mm

**4.5.3 RCD**

The SunMaster CS is equipped with an internal RCD, refer to specifications for tripping values. If an external RCD is used, Mastervolt advises to use A, B, or AC sensitive devices with a trip current of at least 300 mA.



**CAUTION!**

If you use RCD's in your installation, connect maximum one CS inverter to an RCD

**4.6 LIGHTNING PROTECTION**

In a solar installation, precautions must be taken to avoid damage from surges induced by lightning. The CS inverter is equipped with class III (micro) protection devices against over voltages on all DC, AC and communication connections. Additional external surge protection and use of flexible cable is strongly recommended. StringMaster string boxes feature class II surge protectors and are available from Mastervolt. When used, surge protectors must be installed less than 10m away from the inverter.

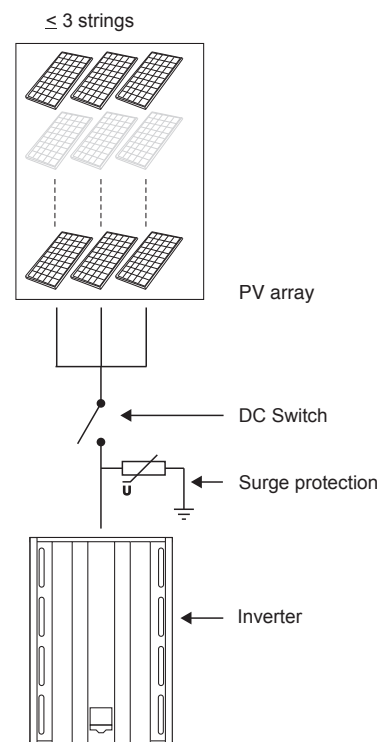

Figure 4-4: Surge protection in a PV installation

## 5 GENERAL INSTALLATION AND COMMISSIONING

This chapter describes the general installation of one single inverter. For example, specific installations with more than one inverter and transformers are explained in chapter 9 and 10.



**CAUTION**

At least until all components have been verified to be de-energized, 2 persons are required during installation.



**CAUTION!**

Read chapters 2 and 4 prior to installation.



**WARNING**

High voltages (up to 1000 VDC) may exist on the PV strings! Switch off the solar voltage and verify that no dangerous voltage is present, before starting the cable work. Use suitable testing equipment



**CAUTION!**

Short circuiting, miswiring or reverse polarity may lead to damage to the CS inverter, the cabling and/or the terminal connections. Follow all steps of the installation instructions in order of succession as described.

### 5.1 THINGS YOU NEED FOR INSTALLATION

Make sure you have all the parts you need to install the CS inverter:

- 1 CS inverter (included)
- 1 mounting bracket (included)
- 1 AC 3-phase output plug (included)
- String combiner box like the StringMaster or the Switchmaster.

- 2 MasterBus terminating devices (included)
- This user's and installation manual (included)
- M6 bolts and plugs to fix the CS enclosure to the wall. Use mounting materials that are suitable for the application.
- Tools for wall mounting
- Tools to connect, AC, DC and communication wiring
- A suitable multimeter

### 5.2 UNPACKING THE CS INVERTER

The CS inverter is packed in a plastic bag and delivered in a special transport box, refer to figure 5-2.

1. Cut open the card board box with a sharp knife.
2. Remove manual and bracket and take away the cover.
3. Cut the tie wraps and lift the inverter from the box. The inverter can be put on its four foot stands before hanging it to the wall. Take care not to bend parts of the enclosure.

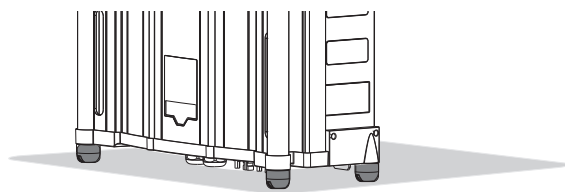

Figure 5-1: Foot stands



After unpacking, check the contents for possible damage. Do not use a damaged product. If in doubt, contact your supplier.

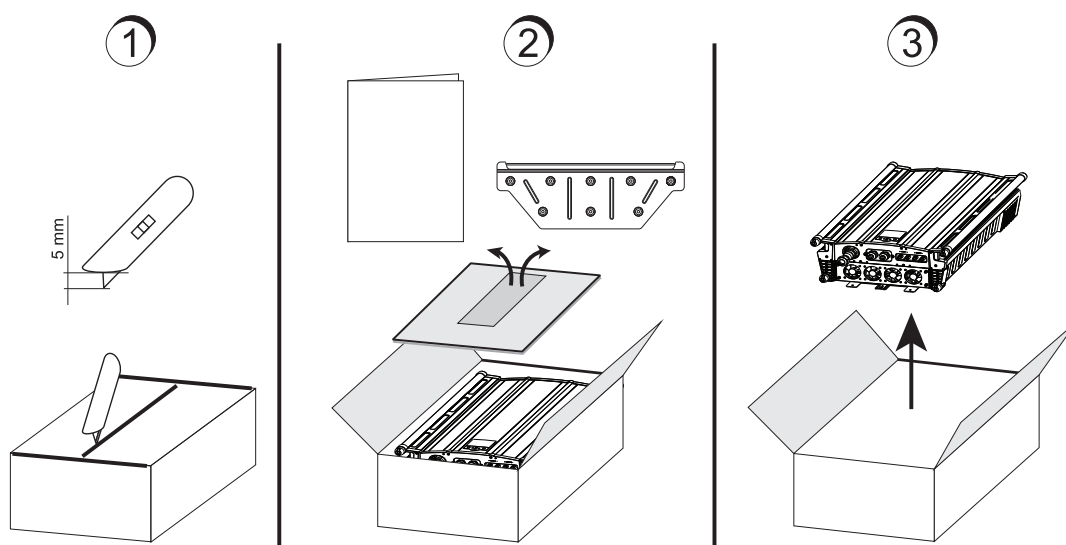

Figure 5-2: Unpacking

**5.3 MOUNTING THE INVERTER**

Fix the CS inverter to the wall, starting with the mounting bracket. See figure 5-3. Use suitable screws and plugs.

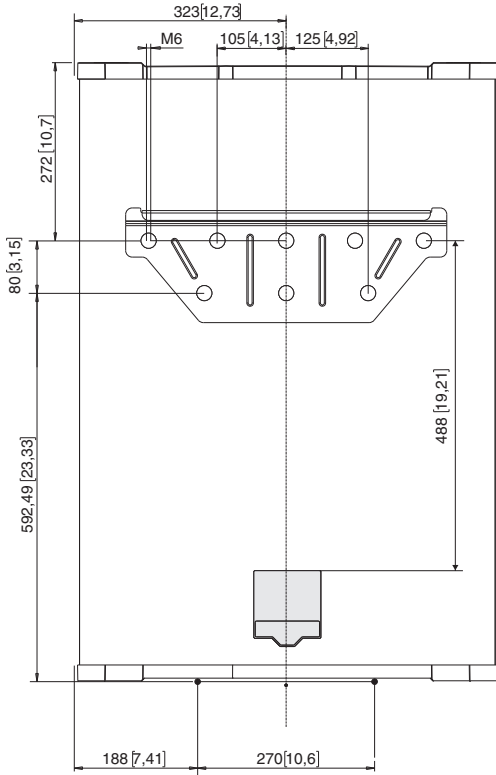

Figure 5-3: Drilling dimensions of bracket and display

After hanging the SunMaster CS to the bracket, secure the enclosure to the wall using the fixing plate. See figure 5-4.

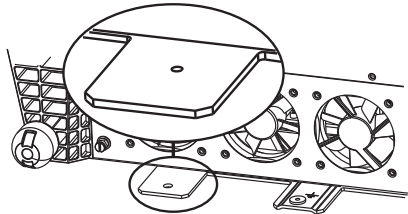

Figure 5-4: Fixing plate

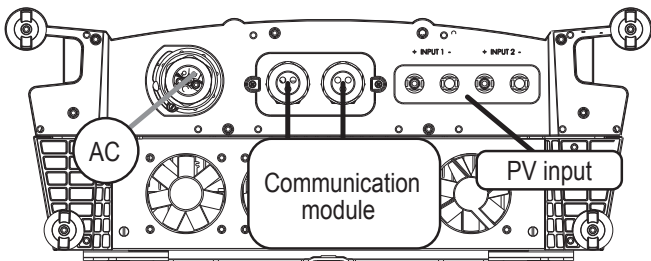

Figure 5-5: Bottom view of the SunMaster CS connections

See figure 5-5.

AC connector: refer to section 5.4,

Communication module: refer to chapter 7,

PV input: refer to section 4.3.

**5.4 AC 3-PHASE CONNECTOR**

The AC connector has five wire terminals, figure 5-6 shows the connector. Connect PE first (yellow-green). On the CS30TL connector, the PE terminal is located at the bottom when the two white markings at the other side of the connector are facing upwards.

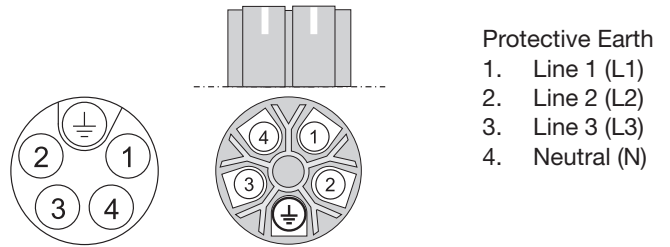

Figure 5-6:

AC 3-phase connector for CS15TL RP and CS20TL RP (left) and for CS30TL RP (right)

A ground stud has been provided, see figure 5-7.

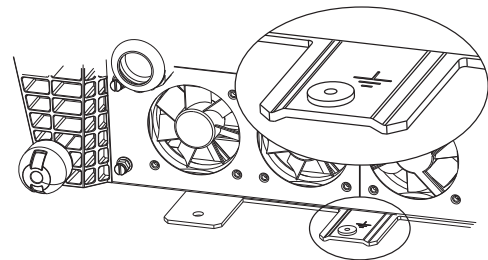

Figure 5-7: Ground stud

**5.5 DC CONNECTORS**

The DC connectors on the SunMaster CS are compatible with connectors of the MC 4 type.

## 5.6 CONNECTING AND COMMISSIONING

To check the correct operation of the CS inverter, commissioning should be carried out during daytime only.

Follow these steps to switch On the SunMaster CS:

- 1 Connect the earth cable to the ground stud.
- 2 Check AC and DC cabling and connectors.
- 3 Connect the AC cables.
- 4 Connect the DC cables.
- 5 If applicable, switch on the AC grid.
- 6 Move the DC switch (if applied) of the solar array to the ON position.

### 5.6.1 Language and country selection



Until the CS inverter is configured in accordance with the local regulations for grid connection, it will stay in standby mode. This means that no power will be converted.

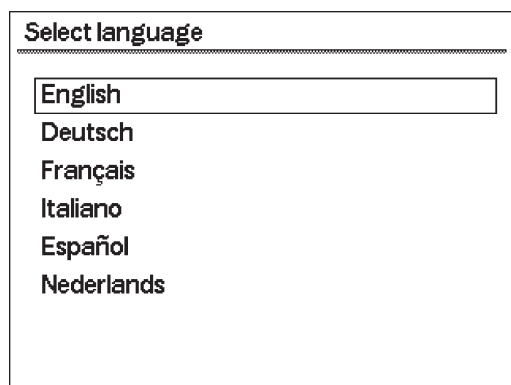

Figure 5-8: Select language

- 1 Select the language, using the display. This setting is found under Configuration/ Display settings/ Language.

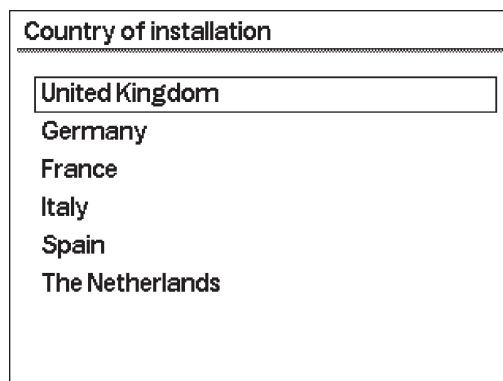

Figure 5-9: Select country

- 2 Select the country, using the display. This setting is found under Configuration/ Grid interface/ Country.

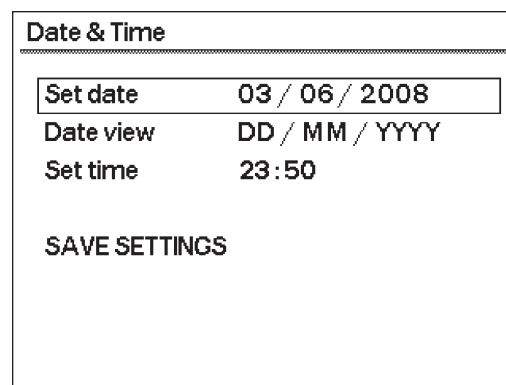

Figure 5-10: Set date and time

- 3 Set the day and time.
- 4 Check the PV input DC voltage. Check the AC voltage at the grid side of the AC circuit breaker using the display multimeter menu (see section 8.6). The AC voltages should be:

L1 - N	230V AC +/- 10%
L2 - N	230V AC +/- 10%
L3 - N	230V AC +/- 10%



If DC and AC voltages are within range and solar irradiation is sufficient, the CS inverter will switch on automatically. This may take a few minutes.

## 6 OPERATION AND MAINTENANCE

This chapter describes the operation of one single inverter.

### 6.1 GENERAL

After installation and commissioning the CS inverter will switch on automatically if solar irradiation is sufficient. The CS inverter operates automatically: there is no need to operate it manually. If the irradiation of the PV modules is insufficient, for instance at night, the CS inverter switches off automatically. The LCD screen however stays operational as long as AC power is available. No live measurements are available in this situation.

### 6.2 MAINTENANCE



Switch off the DC switch before any maintenance takes place!

#### 6.2.1 Cleaning

Cleaning of the CS inverter enclosure is not necessary under normal circumstances. If cleaning is still preferable, use a soft damp cloth to clean the enclosure of the CS inverter. Never use any aggressive or abrasive cleaning agents. Use of high pressure cleaning equipment is prohibited as it may damage the sealing.



High Pressure cleaning of the Sumaster CS is not allowed!

#### 6.2.2 Fan module



Only remove the fan module when the CS inverter is switched off.

The fan module (figure 6-1) needs checking and cleaning every 12 months, in dusty environments checking is needed more often. Unscrew the 4 hand screws as indicated. Carefully move out the fan module, bottom first and unplug the four fans before removing the module completely. If necessary, clean the fans using compressed air.

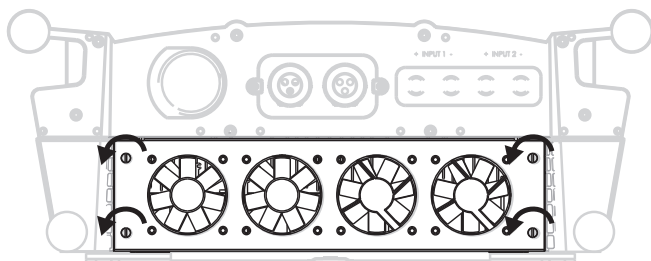

Figure 6-1: Fan module with hand screws

#### 6.2.3 Air outlet

The CS inverter is provided with wire mesh behind the air outlets (fig. 6-2).

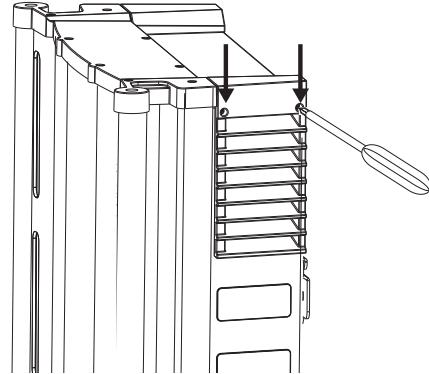

Figure 6-2: Removing the air outlets

Remove the two air outlets by unscrewing the two Phillips screws on top. Clean if necessary.

#### 6.2.4 Electrical connections

Have your electrical installation checked by a qualified installer at least once a year. Defects such as loose connections, burnt wiring etc. must be corrected immediately.

### 6.3 DE-COMMISSIONING

If it is necessary to put the CS inverter out of operation, follow the instructions in order of succession as described below:



#### CAUTION!

Follow below mentioned instructions in order of succession as described.

- 1 Switch Off the DC switch
- 2 Cut off the grid voltage by switching off the AC circuit breaker
- 3 Release the AC connector
- 4 Release the DC connectors. A special tool may be needed to release the DC connectors.
- 5 Disconnect the ground (PE) connection

Now the SunMaster CS can be demounted in a safe way.



#### CAUTION!

Never release the DC plugs during operation of the CS inverter. A spark or an electric arc may develop, in which case both plug and socket of the CS inverter must be replaced.



#### CAUTION!

Be sure to disconnect all other cables before disconnecting PE.



## 7 COMMUNICATION

### 7.1 COMMUNICATION MODULE

The CS inverter is equipped with a detachable communication module (drawer) for inserting the MasterBus and RS485 plugs. It also facilitates mounting the alarm wiring.

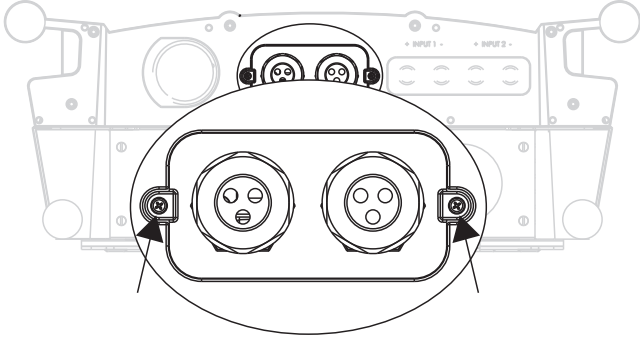

Figure 7-1: Communication module

Install the communication wiring, see the steps below:

- Loosen the Phillips screws at both sides of the front plate (see figure 7-1).
- Pull out the module, taking care not to damage the connectors and components.
- Release glands and remove plugs where applicable.
- Insert the connectors and mount the alarm wiring. See the label in figure 7-2 for more information.

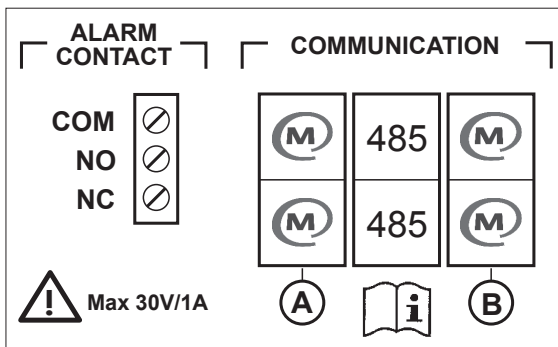



Figure 7-2: Communication label

 MasterBus connectors are similar to RS485 connectors! Wrong installation causes communication failure.

### 7.2 MASTERBUS NETWORK

All devices that are suitable for MasterBus are marked by the MasterBus symbol.

MasterBus is a fully decentralized data network for communication between the different Mastervolt system devices. The communication network is based on CAN-bus which has proven a reliable bus-system. New devices can be added to the existing network by just extending the network. This gives the MasterBus network a high degree of flexibility for extended system configuration. Mastervolt also offers several interfaces, making even non-MasterBus devices suitable to operate in the MasterBus network.



#### CAUTION:

Never connect a non-MasterBus device to the MasterBus network directly! This will void warranty of all MasterBus devices connected.

### 7.3 MASTERBUS CONNECTORS

The CS inverter is equipped with 2 x 2 MasterBus connectors (A and B) to install two MasterBus networks. Network A is reserved for the string box or a transformer connected to the CS inverter. The other network (B) is reserved for communication and updating the inverter.

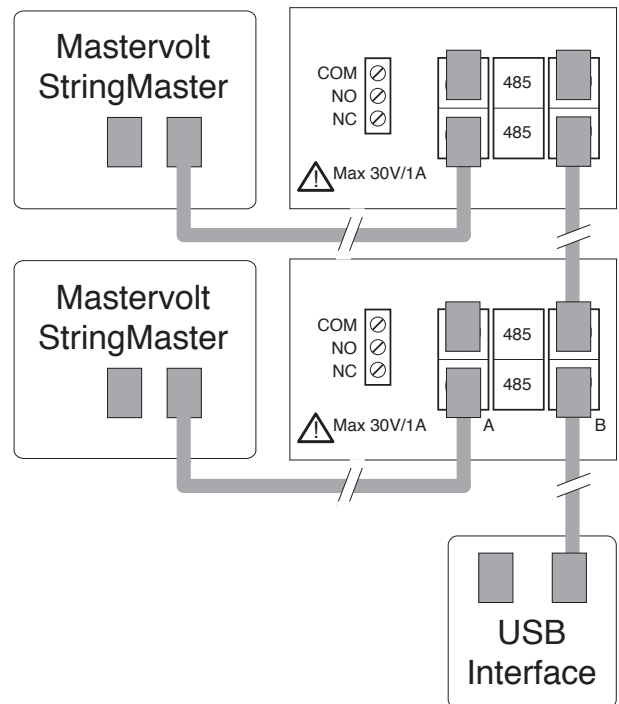

Figure 7-3: MasterBus network example

Proceed as follows to remount the communication module:

- Close any unused holes in the glands, using the premounted caps.
- Insert communication module, using the guidance rails.
- Fix the Phillips screws at both sides of the front plate (see figure 7-1).



For MasterBus connection of the CS-IT20 isolation transformer, refer to section 6.5.3.



Install the communication cables separated from the AC and DC cables to prevent communication loss caused by interference!

#### 7.3.1 How to set up a communication network

Every device that is suitable for the RS 485 and MasterBus network is equipped with two data ports. When two or more devices are connected using these ports, together they form a local data network.

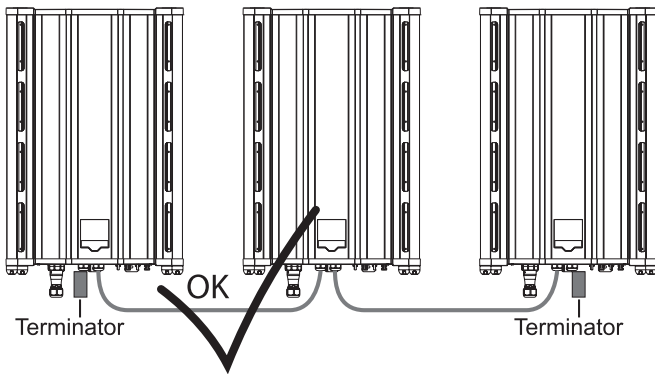

Figure 7-4

**7.4 RS485 CONNECTORS**

The two connectors in the centre of the connection block are RS485 connectors. They can be used for connecting up to 20 CS inverters. They also connect your inverter to an optional Datalogger. We recommend not to make a ring network or T-connections in your RS485 network. The maximum network length is 1000m.

Connections between the devices are made by standard straight UTP cables. Mastervolt can supply these cables. These cables are also commonly available at computer supply stores.

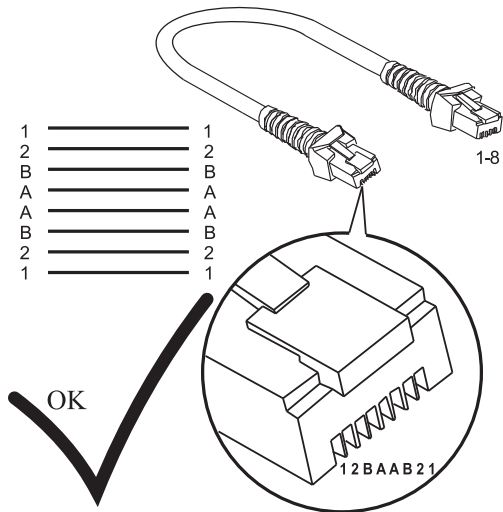

Figure 7-5

**7.5 REMOTE MONITORING WITH RS485**

Mastervolt provides several monitoring solutions like PC software, dataloggers, remote monitoring and so on. Consult [www.mastervoltsolar.com](http://www.mastervoltsolar.com) for a comprehensive overview of all possibilities.

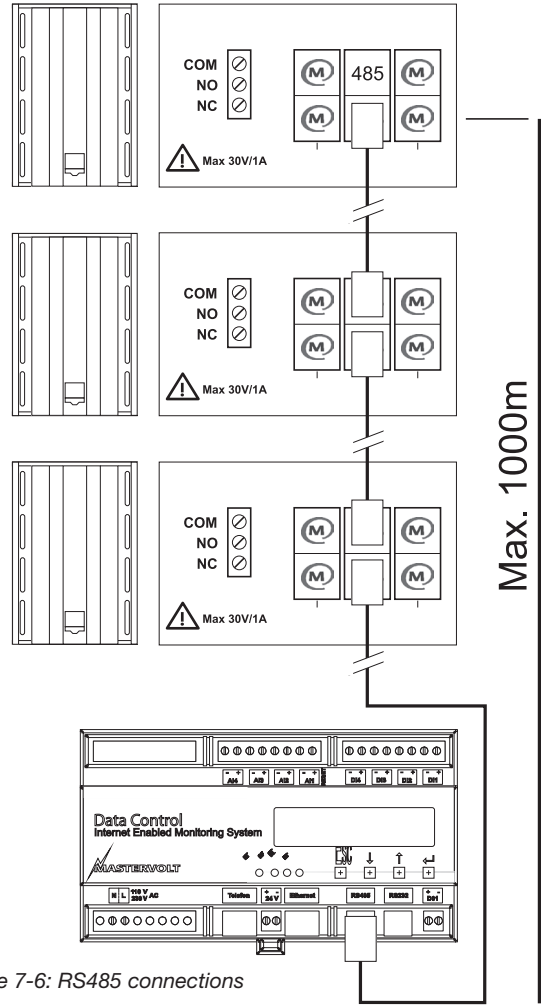

Figure 7-6: RS485 connections

**7.6 PLANT TOTALS**

RS 485 connection of the inverters also enables display of the plant totals. These are the power totals, calculated by adding the individual powers of all connected inverters. Refer to section 8.5.1.

**7.7 ALARM CONTACTS**

See figure 7-7, left part. The three alarm contacts (maximum load 30V/1A) are Common (Com), Normally Open (NO) and Normally Closed NC, see figure 7-7. Refer to section 8.9.5 for alarm contact settings.

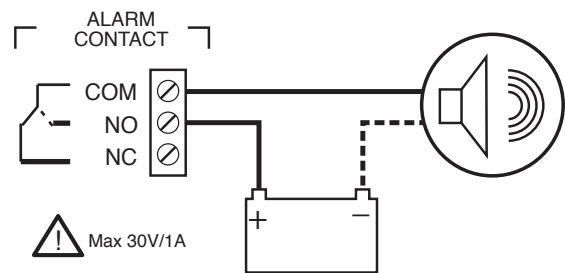

Figure 7-7: Alarm contacts schematic example

## 8 DISPLAY

The SunMaster CS is fitted with a multi-lingual graphic display allowing to view operational data and access all setting parameters. It also provides access to plant data and StringMaster Pro measurements when connected in the installation.

### 8.1 BUTTONS

The CS inverter display has six buttons and a two-colour LED, refer to figure 8-1.

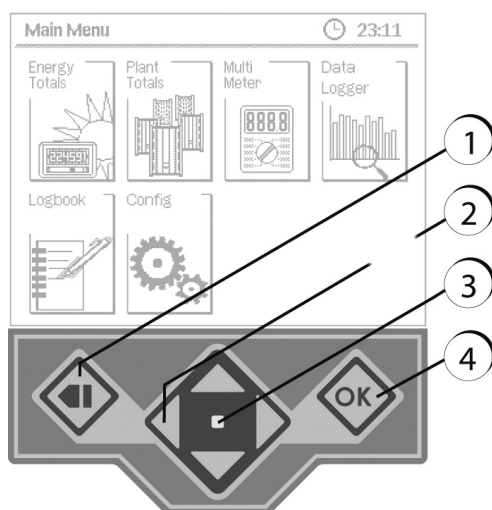

Figure 8-1: Display, buttons and LED

### 8.2 THE HOME SCREEN

The default screen shown in the display is the Home Screen. It is presented in figure 8-2. If no buttons have been pushed for some time, the inverter automatically returns to this screen. The Home Screen shows a summary of the actual inverter status, warning and error messages and additional information if available.

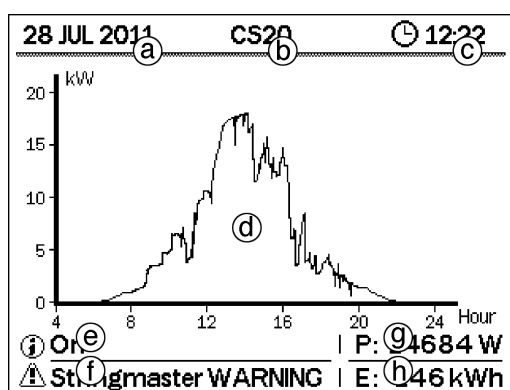

Figure 8-2: Home screen

- a. Current date
- b. Inverter ID
- c. Current time

- d. Today's power generation
  - e. Inverter status, error messages and warnings
  - f. StringMaster status and messages or Plant Totals information
  - g. Current output power
  - h. Energy generated today
- In case an alarm occurs, it will appear on the screen.

### 8.3 MAIN MENU

Pushing the BACK button allows to switch back and forth between the Home Screen and the Main Menu. The Main Menu, shown in figure 8-3, is the starting point to access all inverter information and settings.

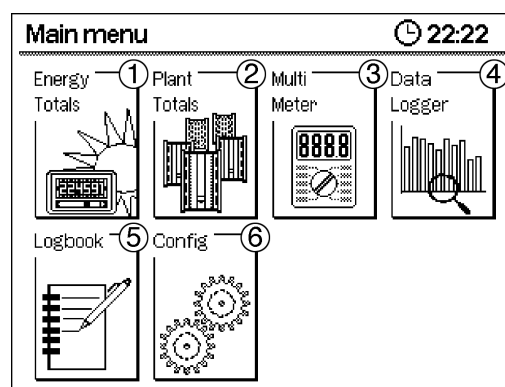

Figure 8-3: Main menu

The Main Menu shows 6 icons. Select one of the icons using the Navigation buttons and press OK to enter one of the following menus:

1. Energy Totals. Total power generated since first commissioning.
2. Plant Totals. Actual measurements and status info of all inverters connected in the PV plant.
3. Multi Meter. Detailed measurements of this inverter and the connected StringMaster.
4. Data Logger. History of power and energy generated by this inverter.
5. Logbook. History of error and warning messages for this inverter.
6. Config. Access to the settings menu.

The BACK button has the display return to the Home Screen

### 8.4 ENERGY TOTALS

The Energy Totals screen (see figure 8-4) shows the total power generated by this inverter since its commissioning to date, the related financial savings and the CO<sub>2</sub> emissions that have been avoided with this renewable energy source.

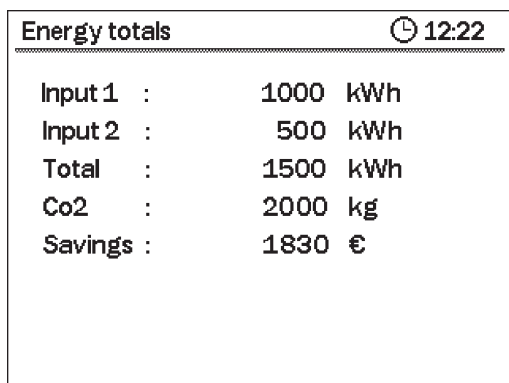

Figure 8-4: Energy totals

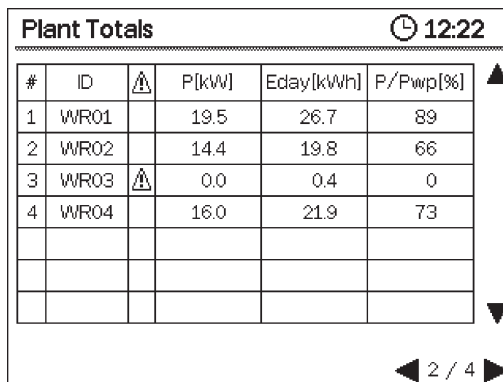

Figure 8-6: Plant Totals screens 2

The BACK button has the display return to the Main Menu.

### 8.5 PLANT TOTALS

If multiple CS inverters have been connected to each other via RS485 cables, the Plant Totals function screen will collect information from all connected inverters and show a summary on the display. Refer to section 7.6 for more information on how to set up the PV plant with Plant Totals functionality. The Plant Totals function is split into 4 different screens, shown in figures below.

#### 8.5.1 Plant Totals – Overview

The Plant Totals (PT) Overview screen shows a bar graph summarizing the performance of the entire PV plant. Each bar represents the actual\* AC power output of one inverter. In case a particular inverter has an error, an exclamation symbol is shown instead of the power bar. See figure 8-5. Below each bar, each inverter is referenced with a number. This number corresponds with the inverter number used in the next Plant Totals screens. In the bottom of the screen, the actual\* sum of all power generated by the plant is shown. Pushing the BACK button has the display return to the Home Screen. Pushing the LEFT or RIGHT navigation button will scroll to the previous/next Plant Totals screen.

\* Due to delays in the communication line and a limited update frequency, the power figures shown in the plant totals screens may differ from the information presented on that particular inverter.

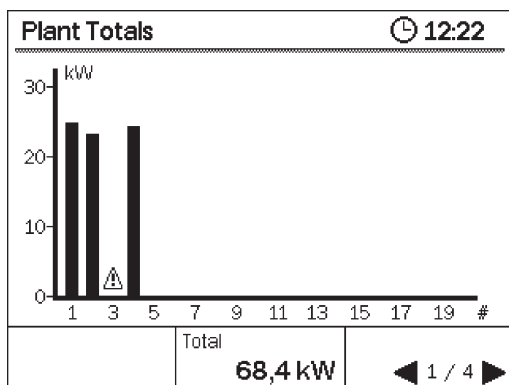

Figure 8-5: Plant Totals screens 1

#### 8.5.2 Plant Totals – Inverter Information

The performance of each inverter in the plant is further detailed in the Inverter Info screens. By using the LEFT and RIGHT Navigation buttons, the information table can be shifted to the left or right. The following information is available for each inverter:

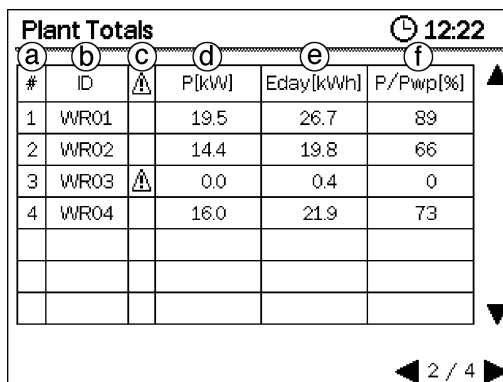

Figure 8-7: Plant Totals Info 1

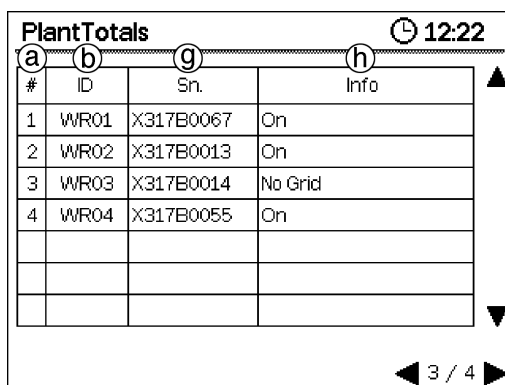

Figure 8-8: Plant Totals Info 2

- a. Inverter Number.** This number relates to the power bar shown in the PT Overview screen.
- b. Inverter ID.** A four-character code to identify each inverter. This ID list is sorted alphabetically.
- c. Inverter Error.** If a particular inverter has an error, an exclamation symbol is shown in the list.
- d. Actual Power.** The power currently generated by that inverter.
- e. Energy Generated.** The energy generated today by that inverter.
- f. Relative Performance.** The actual inverter power relative to the rated PV panel capacity installed on that inverter.
- g. Serial Number.** The serial number of that inverter. When identical inverter IDs are used, the list is sorted on the serial number.
- h. Status Info.** The current status of that inverter. If the inverter has an error, concise information of the error type is shown here.

### 8.5.3 Plant Totals – Setup

The fourth screen in the plant totals menu allows to set up the Plant Totals configuration.

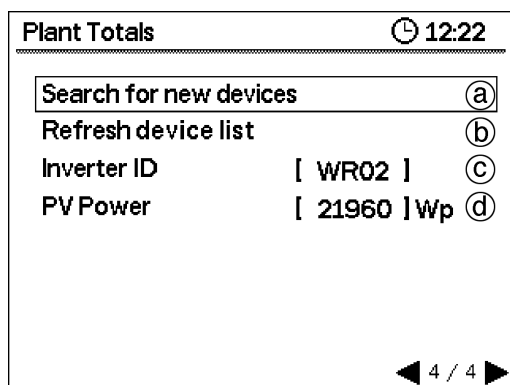

Figure 8-9: Plant Totals Setup

Select one of the options by using the UP and DOWN Navigation buttons:

#### a. Search Inverter

If not all inverters are shown in the previous screens, select this option and press OK to search the bus for new inverters.

#### b. Refresh

Select this option and press OK if the plant configuration has been changed. (for example, when replacing an inverter).

#### c. Inverter ID

A four-character alphanumeric identification can be given to each inverter in the plant. It is possible to use the same ID multiple times. Select this option and press OK to adjust the ID

The first character of the ID is now highlighted. Use the UP/DOWN navigation buttons (push or hold down) to scroll through all possible characters. When the desired character is highlighted, use the LEFT/RIGHT navigation button to select the next or previous character. Pressing OK will save the ID to the inverter memory. BACK will cancel the operation and returns to the settings menu.

#### d. PV power

The rated PV panel capacity installed on this particular inverter. Setting this number will provide a more accurate calculation of the relative inverter performance shown in the PT Inverter Info screens. Select this option and press OK to adjust this value. The first number will be highlighted. Use the UP/DOWN/LEFT/RIGHT navigation buttons to adjust each number and select the next/previous number. Pressing OK will save the new value to the inverter memory. BACK will cancel the operation and has the display return to the settings menu.

### 8.6 MULTIMETER & STRINGMASTER

The Multimeter screen shows actual voltage, current and power measurements for the inverter. If a StringMaster CS 2-6 SW Pro is connected to the inverter, current measurements and health monitoring of each string are provided as well.

INPUT1		INPUT2	
P	9100 W	P	9250 W
U	600 V	U	620 V
I	15.2 A	I	14.9 A

OUTPUT			
P	U (V)	I (A)	f (Hz)
U (L1)	230	14.8	50.1
V (L2)	231	14.7	50.0
W (L3)	230	14.8	50.1

Figure 8-10: Multimeter inputs/output

Figure 8-10 shows the general Multimeter screen. Voltage, current and power measurements are shown for both DC inputs. The output measurements show RMS voltage, current and grid frequency on each phase.

The measurements shown in the Multimeter menus are subject to metering inaccuracies and may not be correlated to each other in time. These values can therefore not be used for performance evaluations such as efficiency calculation and power point tracker performance.

Each SunMaster CS inverter can communicate to one StringMaster CS 2-6 SW Pro String Combiner Box using the Masterbus protocol. Refer to sections 7.1 to 7.4 for information on how to set up a MasterBus network between the CS inverter and the StringMaster.

When connected, the inverter will automatically detect the StringMaster and show the measurements in the Multimeter screen shown in figure 8-11.

Use the LEFT/RIGHT navigation buttons to switch between the Multimeter and StringMaster screens. The BACK button will return the display to the Main Menu.

Before showing accurate information, the StringMaster measurements must be configured in the StringMaster Settings menu. Refer to section 8.10.9 for additional information.

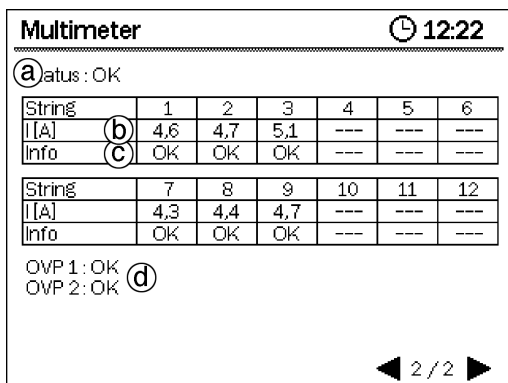

Figure 8-11: Multimeter inputs per string

The StringMaster screen provides the following information:

- a. StringMaster Status. Refer to the table below for status information.
- b. String Current. The current measured for each string.
- c. String Info. Monitoring information for that particular string. Refer to the table below for status information.
- d. OVP Status. Trip status of the Surge Protectors inside the StringMaster.

If the StringMaster is not connected or has an error, some or all items may show three dashes (---) instead of a value. The table below shows the Status and String info messages and their meaning.

StringMaster Status Information	
OK	StringMaster is ON and operating normally
ALARM	StringMaster has detected a problem in the PV installation
ERROR	StringMaster has an internal error or has lost communication
Not Connected	StringMaster is not connected (and has not been connected previously)
StringMaster String Info	
---	String is not configured, StringMaster has an error or is not connected
OK	String is healthy
OC	String has exceeded maximum current of 30A
NEG	String current is reversed
LOW	String current is below PV array performance. See section 8.9.9 to configure health monitoring

### 8.7 DATALOGGER

Every SunMaster CS inverter is fitted with an internal Datalogger that allows the user to track the inverter performance over the past. The datalogger can store energy data for up to 10 years with adaptive resolution. With adaptive resolution, energy data becomes more summarized when looking further back in the past:

- Day-to-day energy shows a 10-minute accurate profile of the energy generated for the past 30 days.
- Month-to-month energy shows the daily energy yield for the past 12 months.
- Year-to-year energy shows the monthly energy yield for the past 10 years.

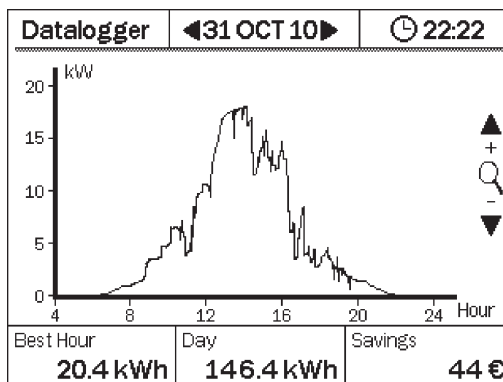

Figure 8-12: Datalogger, day-to-day energy.

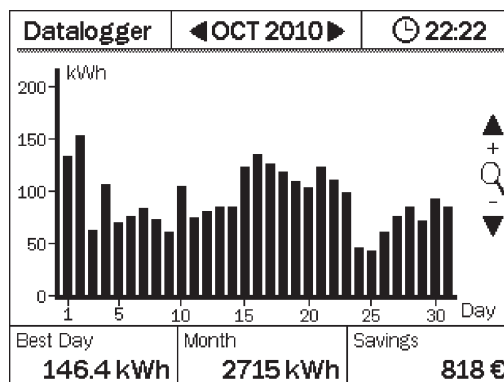

Figure 8-13: Datalogger, month-to-month energy.

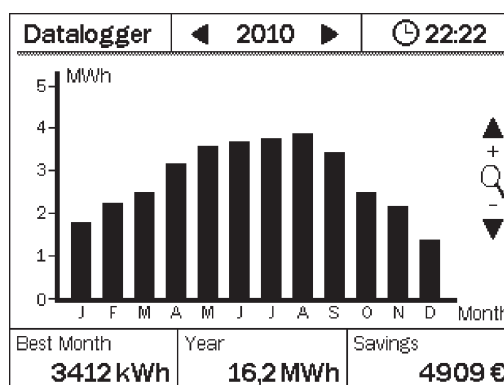

Figure 8-14: Datalogger, year-to-year energy.

Use the buttons to navigate through the datalogger information. LEFT/RIGHT will select the next/previous day, month or year. UP will zoom in, increasing the resolution, DOWN will zoom out, showing a larger timespan. The BACK button will return the display to the Main Menu. In the bottom of the Datalogger screen, some statistics are shown:

- Best hour/day/month. For example, how much energy was generated at the best hour of the shown day.
- Day/Month/Year Energy. The total energy generated over the time span shown.
- Savings. The amount of cost saved over the time span shown.

### 8.8 LOGBOOK

The Logbook lists the 30 last errors and warnings that have occurred in the inverter. Refer to figure 8-15.

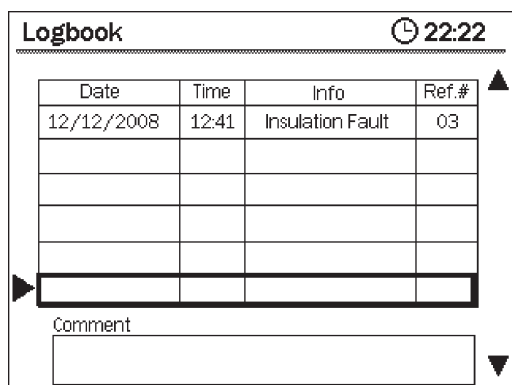



Figure 8-15: Log book

Every notification is listed together with a time stamp (date & time), and an error reference. The error reference can be used for trouble shooting (see chapter 12) or getting technical support. Use the UP/DOWN navigation buttons to scroll through the list. The BACK button will return the display to the Main Menu. For each selected notification a short description, possible cause or possible solution is provided in the comments box.

 StringMaster errors and warnings are not recorded in the LogBook.

### 8.9 CONFIGURATION MENU

The Configuration Menu provides access to all inverter settings except Plant Totals. Note however that some settings may be password protected and are not accessible unless the Installer Code is provided.

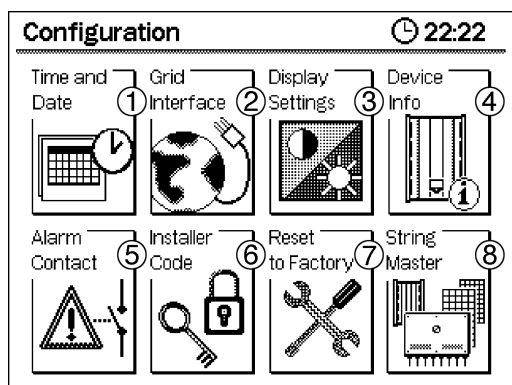

Figure 8-16: Configuration screen

The Main Menu shows 8 icons as presented in figure 8-16. Select one of the icons using the Navigation buttons and press OK to enter one of the following menus:

1. Time and Date (see section 8.9.1)
2. Grid Interface (see section 8.9.2)
3. Display Settings (see section 8.9.3)
4. Device Info (see section 8.9.4)
5. Alarm Contact (see section 8.9.5)
6. Installer Code (see section 8.9.6)
7. Reset to Factory (see section 8.9.7)
8. StringMaster (see section 8.9.8)
9. Automatic string performance monitoring (see 8.9.9)

Pressing the BACK button has the display return to the Main Menu. In every menu, each parameter or part of it can be selected and modified using the four navigation buttons. Pressing OK will confirm the selection or store the modified value. The BACK button will cancel the current action or return to upper menu level.

#### 8.9.1 Date and time settings

The SunMaster CS inverter has an integrated real-time clock that operates even with no AC or DC power applied. The date and time settings can be adjusted in the menu shown in figure 8-17.

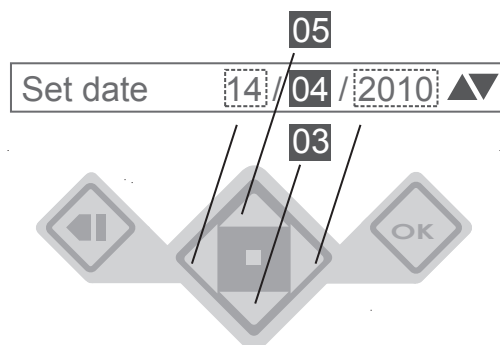

Figure 8-17: How to set values on the LCD screen

The following parameters can be adjusted:

- Set date. Set the current date.
- Date view. Switch between DD/MM/YYYY and MM/DD/YYYY
- Set time. Set the current time.

#### 8.9.2 Grid Interface

The grid interface is locked with the installer password. Under normal circumstances it is not necessary to modify these settings. Every SunMaster CS inverter is pre-programmed with default country settings that comply with the grid code requirements of the installation country.

Do not modify any of these settings unless you are a qualified installer.

The Grid Interface Menu is split in 5 sub-menus shown in figure 8-18.

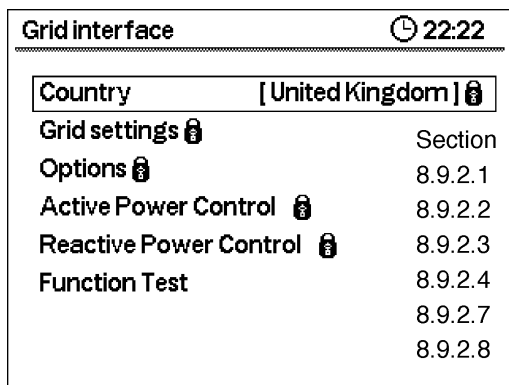

Figure 8-18: Grid Interface

- **Country.** The currently selected installation country. The SunMaster CS supports all countries listed in chapter 10.
- **Grid Settings.** The grid protection settings for the currently selected country
- **Options.** Isolation fault detection and transformer control
- **Active Power Control.** Options to allow controlling the inverter active power output.
- **Reactive Power Control.** Options to allow controlling the inverter reactive power output.

8.9.2.1 Grid Settings

For every country listed in the country table, Mastervolt has prepared a default set of parameters to comply with the grid code applicable for that country. These settings do not need to be adjusted in any normal case. Only if absolutely necessary, or if the installation country is not listed (yet), the grid settings can be modified in this menu. If the grid settings for a country are modified, the inverter will automatically show “Custom” as the selected country. Selecting the original country again will revert the inverter to the default country settings.



Changing the grid settings should not be done under normal circumstances. Without prior written permission from Mastervolt, changing these settings will void the warranty and could void compliance to the national grid codes.

8.9.2.2 Options

The options menu controls the Insulation Fault detection and the isolation transformer relay. Refer to figure 8-19.

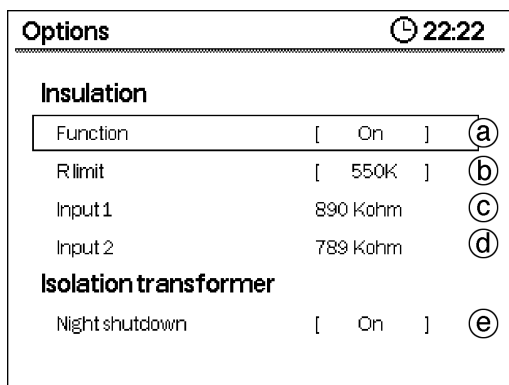

Figure 8-19: Options

Insulation

**a. Function.** Describes how the insulation detection should respond to a fault. There are several options:

- On For normal installations. Inverter will shut down in case of insulation failure. (Default Setting)
- Neg GND For functional grounding on the Negative PV Terminals. Inverter will shut down in case the grounding is released.
- Pos GND For functional grounding on the Positive PV Terminals. Inverter will shut down in case the grounding is released.
- Input 2 NC Setting to operate the inverter with input 2 not connected. Inverter will shut down in case of insulation failure on Input 1.
- Input 1 NC Setting to operate the inverter with input 1 not connected. Inverter will shut down in case of insulation failure on Input 2.
- Off Ignore insulation failures.

Setting the Insulation Detection to OFF may present a safety hazard in case the insulation fails. It is not recommended to use this setting unless absolutely necessary.

**b. R limit.** This value sets the limit below which the inverter will show an inverter failure. Depending on the inverter model, the limits are different:

For detailed information about insulation detection levels, please visit the Mastervolt website.

**c. Input 1.** In this screen, the last insulation measurement results for input 1 are shown. Refer to section 9.1.

**d. Input 2.** In this screen, the last insulation measurement results for input 2 are shown.

Isolation Transformer

**e. Night Shutdown.** Set this option to off (default) to disable transformer control. When set to ON, the inverter will switch the transformer off during the night to save energy.

8.9.2.3 Active Power Control

The CS inverter can reduce its active power output under several circumstances, such as the grid frequency. The active power control settings can be used to change the inverter behaviour.

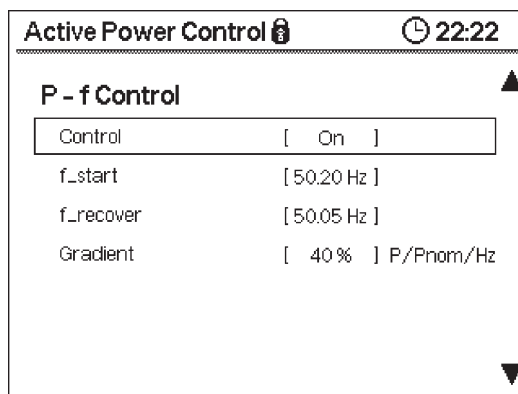

Figure 8-20: Active Power Control configuration



**8.9.2.4 DNO Power Control**

For some PV installations, the local grid operator (Distribution Network Operator, DNO) may require the possibility to reduce the power output of the PV plant by remote commands. In such case, a Telecontrol receiver must be installed. Refer to section 10.3.1.

**8.9.2.5 Frequency dependent Power Control**

The SunMaster CS can reduce its output power autonomously if the grid frequency exceeds the nominal value. Refer to section 10.3.2.

**8.9.2.6 Reactive Power Control**

The CS inverter can produce reactive power with different control mechanisms. The reactive power control settings can be used to change the inverter behaviour. Refer to section 10.5.

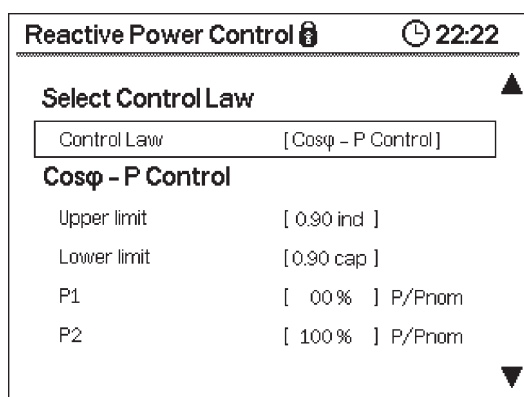

Figure 8-21: Reactive Power Control configuration

- Select control law
- Cos-phi control
- Constant cos-phi
- Q-U control
- Constant Q

**8.9.2.7 Function test**

This option only appears if you selected Country code Italy. Refer to chapter 10.2

**8.9.3 Display Settings**

This menu allows to adjust the user preferences for the Display. Refer to figure 8-22.

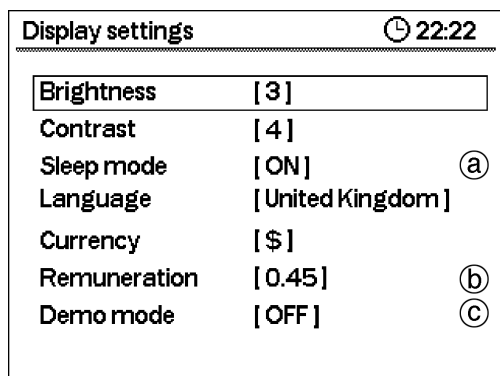

Figure 8-22: Display settings

- a. **Sleep Mode.** Sleep mode switches off the backlight, and returns the display to the Home Screen, when no buttons are pressed for more than 5 minutes
- b. **Remuneration.** Set this value to the price per kWh applicable for the installation
- c. **Demo Mode.** Shows samples for some measurements.

Table with display settings ranges

Display Settings	
Setting	Range
Brightness	1 – 5
Contrast	1 – 5
Sleep Mode	On, Off
Language	English, Dutch, Spanish, Italian, French, German
Currency	\$, €
Remuneration	0.00 – 9.99
Demo Mode	On, Off

**8.9.4 Device Info**

These screens show the inverter model, serial number and firmware revision numbers.

The commissioning date is the date when more than 10 kWh has been produced or when more than 30 operating hours have been accumulated.

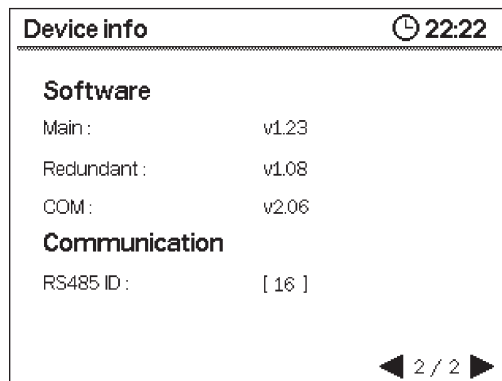
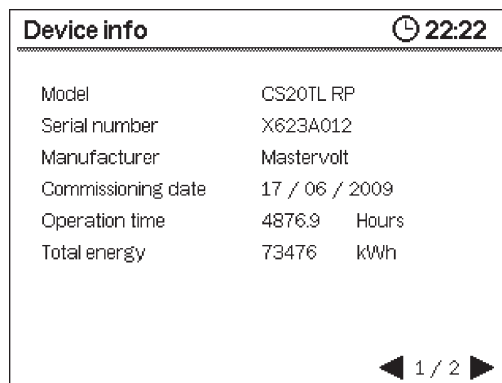

Figure 8-23: Device information

**8.9.5 Alarm Contact Settings**

The alarm contact settings allow to configure the potential-free alarm contact available in the communication drawer. Refer to section 7.7 for connection examples using the alarm contact.

The following settings are available:

Alarm Contact Settings	
Alarm	On, Off
Select Event	On, Insulation Error, Solar OK, Grid Fault, Error
Alarm ON Delay	0 – 60 min
Alarm OFF Delay	0 – 60 min

**8.9.6 Entering installer code**

To unlock several settings, such as grid settings and StringMaster configuration, the installer code must be entered in this screen (see figure 8-24). If OK, the inverter unlocks (see figure 8-25). The inverter logs out automatically after some time. Contact Mastervolt to obtain your installer code.

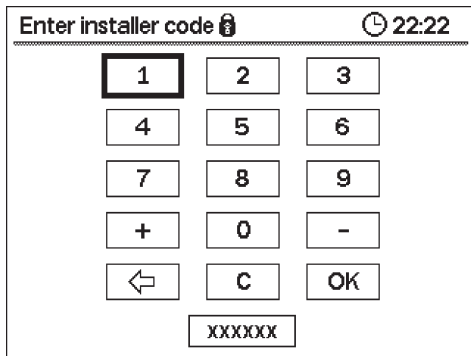

Figure 8-24: Installer code

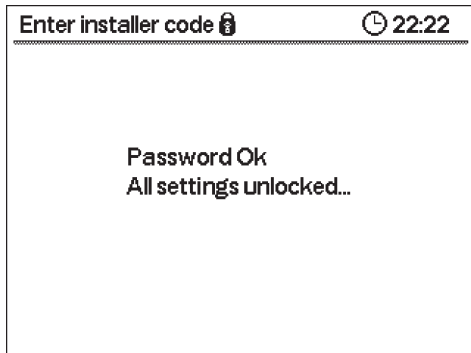

Figure 8-25: Settings unlocked

**8.9.7 Reset to Factory settings**

If the inverter is reset to the factory settings, all user settings and datalogger information will be removed. If this menu is selected, a warning screen appears. See figure 8-26.

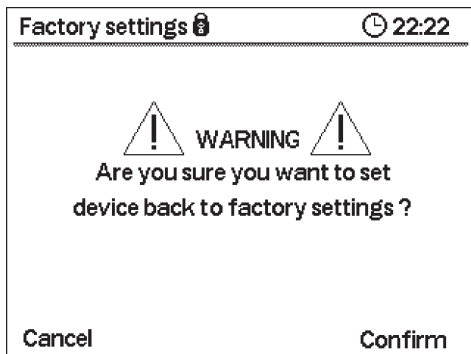

Figure 8-26: Installer code

Pressing Continue confirms to reset the inverter to the factory settings.



The installer password must be entered before the inverter can be reset to factory defaults.

A confirmation screen will appear when all settings have been reset.

**8.9.8 StringMaster Settings**

This section allows to set up the StringMaster monitoring such, that it will suit the PV installation.

See the table below for the available settings.

StringMaster Settings		
<b>Info</b>		
StringMaster Detect	On, Off	Switch to Off if the StringMaster is no longer used.
Software Serial Number	StringMaster Firmware Revision StringMaster Serial Number	
<b>Input 1</b>		
String 1 ... String 6	On, Off	Enables monitoring for this particular string
Deviation	0 – 100%	See explanation below
Threshold	0,5A – 30A	
<b>Input 2</b>		
String 7 ... String 12	On, Off	Enables monitoring for this particular string
Deviation	0 – 100%	See explanation below
Threshold	0,5A – 30A	
<b>OVP</b>		
OVP1 Alarm	On, Off	Shows or ignores the OVP Alarm
OVP2 Alarm	On, Off	
<b>Settings</b>		
Alarm Message	On, Off	Shows or ignores StringMaster errors in the Home Screen and on RS485
Alarm Delay	0 – 1440 min	Sets the duration of an error condition before it is reported.

### 8.9.9 Automatic String Performance Monitoring

Together with the StringMaster Pro, the CS inverter can autonomously monitor the performance of each string and compare it to the rest of the plant. If one string underperforms (for example, because of dust deposits or connector failures) compared to the others in that input, the inverter will issue a warning on the home screen and on both communications buses.

The performance warning is issued when:

1. The current of the failing string deviates more than [D]% from the best performing string, AND
2. The current of the failing string is [T] Ampere less than the best performing string, AND condition 1. and 2. are true for at least [A] minutes.

[D] = String Deviation (Range: 0 – 100%)

[T] = String Threshold (Range: 0,5 – 30A)

[A] = Alarm Delay (Range: 0 – 1440 min)

Figure 8-27 shows the Performance Monitoring function graphically.

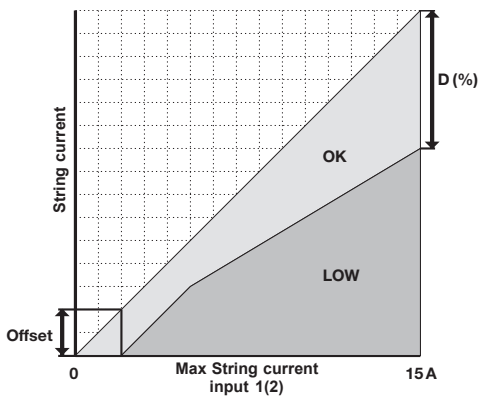

Figure 8-27: Performance Low warning graph

## 9 SPECIFIC DC CONFIGURATIONS

This chapter describes specific features of special installations and options using the CS inverter. It was written to be an addition to chapter 5 General Installation and Commissioning.

### 9.1 ISOLATION DETECTION

Every morning, before the SunMaster CS connects itself to the grid and initiates power conversion, it measures the isolation resistance of the PV installation. This measurement is an important safety check and a mandatory procedure for transformerless inverters.

Due to conflicting safety requirements in different European grid and safety standards, it is possible that a healthy PV installation still triggers the isolation protection mechanism causing unwanted warnings and reducing the installation's energy yield. For more information about this topic, please visit the Mastervolt website or contact your supplier.

In order to retain the flexibility of use with different PV installations, Mastervolt CS inverters offer the option to adjust the protection trip levels for the isolation measurement. The following settings are available:

	CS15TL RP	CS20TL RP	CS30TL RP
<b>High Setting</b>			
Complies with VDE 0126-1-1	1200 k $\Omega$	1200 k $\Omega$	1200 k $\Omega$
<b>Default Setting</b>			
Complies with UL 1741	700 k $\Omega$	550 k $\Omega$	350 k $\Omega$
<b>Low Setting</b>			
Complies with UL 1741 when PV inputs are paralleled	400 k $\Omega$	300 k $\Omega$	200 k $\Omega$

The default settings in the inverter are safe. Do not change the settings unless the installation requires to do so.

### 9.2 USING A STRINGMASTER PRO

#### 9.2.1 DC Distribution

The CS inverter has two independent solar inputs. To accommodate more than two strings, StringMaster and Switchmaster string boxes are available.

Refer to the StringMaster manual for installation instructions. To release the MultiContact connectors, use of the special MultiContact tool is recommended.

When more than three strings are paralleled, they must be fused. For fuse ratings refer to specifications of used fuse. All strings connected to the same Solar-input should consist of the same number of identical PV modules. Measure the solar voltage for each input.

The calculated string voltage equals the open circuit voltage (U<sub>oc</sub>) per PV module (refer to the specifications of the PV module), multiplied by the number of PV modules in each string.

#### 9.3 DC SWITCH

A DC switch may be mandatory in your country. It can be purchased separately or integrated in a StringMaster stringbox. Refer to section 9.3 for more information and to chapter 14 for ordering information. The DC switch is included in the optional Switch- and StringMasters.

## 10 SPECIFIC AC CONFIGURATIONS

This chapter describes specific features of special installations and options using the CS inverter. It was written to be an addition to chapter 5 General Installation and Commissioning.

### 10.1 SUPPORTED COUNTRIES

In the next table, the selectable country codes are displayed.

COUNTRY
Netherlands
Belgium
France
Spain
Italy
Greece
Austria
Germany
Denmark
England
Ireland
Singapore
Taiwan
Korea
China
Custom

### 10.2 FUNCTION TEST FOR ITALIAN INSTALLATIONS

#### GENERAL

The Self Test Function is meant to check the upper and lower limits of the AC voltage and AC frequency at which the inverter will disconnect from the grid.

To enter the Self Test, enter the country selection menu in the Grid Interface menu and choose Italy. In the Grid Interface, select the Self Test menu.

During the self test, next tests are possible:

- Uac Max (high off limit AC voltage);
- Uac Min (low off limit AC voltage);
- Fac Max (high off limit AC frequency);
- Fac Min (low off limit AC frequency).

After each test you have to press Confirm before the inverter starts the reclosure count down and reconnects to the grid.



The standard reclosure time of 300 sec has been reduced to shorten the testing time.  
This is not an error.

The test accuracy is better than 1V/ 0.1Hz if grid voltage and frequency are stable.

Function test		🕒 22:22
<b>Running test</b> <b>Uac Max.</b>		
Measured value	230,0 V	
Setting	276,0 V	
Max. Trip time	100 ms	
<b>Result</b> <b>OK</b>		
Measured Trip time	95 ms	
Calculated limit	276,0 V	
<b>Confirm</b>		

Figure 10-1

Function test		🕒 22:22
<b>Running test</b> <b>Fac Max.</b>		
Measured value	50,00 Hz	
Setting	50,30 Hz	
Max. Trip time	100 ms	
<b>Result</b> <b>OK</b>		
Measured Trip time	85 ms	
Calculated limit	50,30 Hz	
<b>Confirm</b>		

Figure 10-2

Test Results			🕒 22:22
Test	Trip time	Calculated limit	
Uac Max.	95 ms	276,0 V	
Uac Min.	120 ms	184,0 V	
Fac Max.	85 ms	50,30 Hz	
Fac Min.	85 ms	49,70 Hz	

Figure 10-3: Function test summary

**Uo Max-TEST (Uac Min-TEST)**

Figure 10-1 shows:  
 Measured value: = the actual grid voltage;  
 Setting: = the set maximum / minimum inverter voltage limit  
 Max. Trip time = Maximum time for inverter to shut down after tripping

During this test the high (low) voltage limit is changed with Rate -11.5V/sec (+11.5V/sec) until it trips: it reaches the actual grid voltage. The time to trip is called Test duration. The time the inverter needs to shut down after tripping is called the Trip Time.

Result OK if the calculated limit is within range.  
 Trip Time Measured time between tripping and inverter shut down  
 Calculated limit Calculated Uac Max (Uac Min), equals Measured value plus (minus) Rate x Test duration

**Fac Max-TEST (Fac Min-TEST)**

Figure 10-2 shows:  
 Measured value: = the actual grid frequency;  
 Setting: = the set maximum / minimum inverter frequency limit  
 Max. Trip time = Maximum time for inverter to shut down after tripping

During this test the high (low) frequency limit is changed with Rate -0.05Hz/sec (+0.05Hz/sec) until it trips: it reaches the actual grid frequency. The time to trip is called Test duration. The time the inverter needs to shut down after tripping is called the Measured Trip Time.

Result OK if the calculated limit is within range.  
 Measured Trip Time Time between tripping and inverter shut down  
 Calculated limit Calculated Fac Max (Fac Min), equals Measured value plus (minus) Rate x Test duration

Function test		🕒 22:22
<b>Test All</b>		
<b>Uac Max.</b>		
<b>Uac Min.</b>		
<b>Fac Max.</b>		
<b>Fac Min.</b>		
<b>Test Results</b>		

Figure 10-4: Function test selection

**10.3 ACTIVE POWER MANAGEMENT**

This section describes all types of power management available on the SunMaster CS inverter.

**10.3.1 Power management by Telecontrol**

For some PV installations, the local grid operator (Distribution Network Operator, DNO) may require the possibility to reduce the power output of the PV plant by remote commands. In such case, a Telecontrol receiver must be installed.

The SunMaster CS can respond to the power commands when a Data Control Premium II or Data Control Pro is connected to the inverter by RS485. A single datalogger can control up to 20 inverters at the same time. Contact your Mastervolt supplier for more information.

In case the DNO sends a Power Management request to the plant, the CS inverter display will show the current reduction value in the display in the Home Screen.

Refer to figure 10-5.

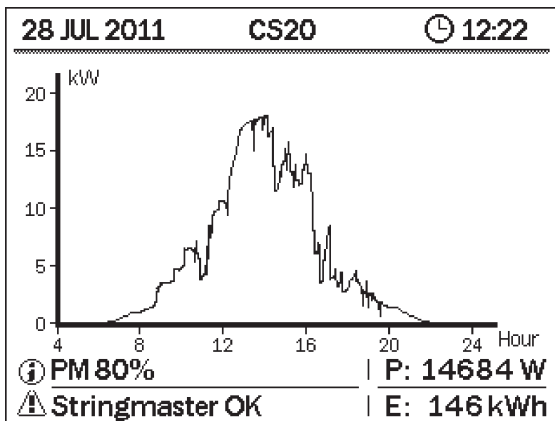

Figure 10-5: Home screen, the Warning can be a power reduction

**10.3.2 Frequency dependent power control**

The SunMaster CS can reduce its output power autonomously if the grid frequency exceeds the nominal value. The inverter has two available control laws.

1. Control Law 1 (compliant to VDE-AR-4105)
2. Control Law 2 (compliant to BDEW)

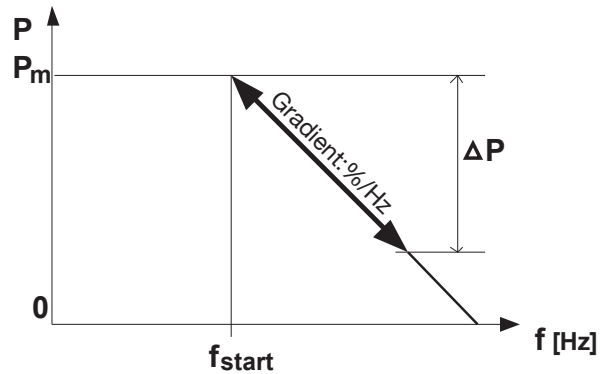

Figure 10-6: Control Law 1 (compliant to VDE-AR-4105)

The inverter will start reducing the output power when the grid frequency exceeds the  $f_{start}$  value. The power reduction (Gradient) is defined as a percentage of actual output power per hertz, according to the following formula:

$$\Delta P = \text{Gradient} \times f_{start} - \text{factual}$$

$P_m$  is the inverter output power when  $f_{start}$  was exceeded  
 Gradient is the relative power reduction per hertz  
 $f_{start}$  is the control trip frequency  
 factual is the actual measured grid frequency

- When the grid frequency rises above  $f_{start}$ , the inverter memorizes the actual output power generated at that moment. The memorized power is stored as  $P_m$ .
- For any grid frequency above  $f_{start}$ , the output power is reduced with the defined Gradient.
- When the grid frequency drops below  $f_{start}$ , the inverter will return to full power operation

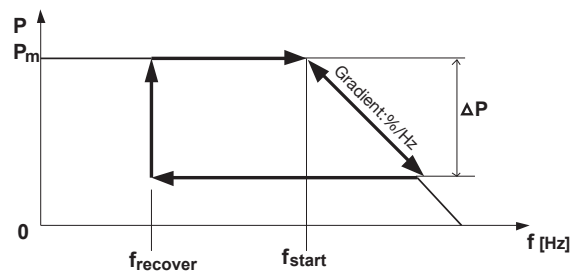

Figure 10-7: Control Law 2 (compliant to BDEW)

Refer to figure 10-7. The inverter will start reducing the output power when the grid frequency exceeds the  $f_{start}$  value. When the grid frequency is reduced, the inverter will clamp the output power to the lowest value achieved, until the frequency has dropped below the predefined recovery frequency  $f_{recover}$ .

**Available Parameters**

A single set of parameters are available to fine-tune the inverter behavior for both control laws. If the VDE compliant control law is selected,  $f_{recover}$  parameter is ignored. The Ramp-Up parameter specifies the speed at which the inverter

will increase its output power after the frequency has recovered, or after a grid fault has been cleared. 4 independent setpoints are available:

Name	Range	Resolution	Default
fstart	50 – 55 Hz / 60 – 65	Hz 0,01	Hz 50,20 Hz
frecover	50 – 55 Hz / 60 – 65	Hz 0,01	Hz 50,05 Hz
Gradient	0% _ 100% P/Pm/Hz	1%	40%
Ramp-Up	0% _ 6000% P/Prated/min	10%	10%
Mode	VDE / BDEW	VDE	

fstart can only be set to a value higher than fhigh,off (fhigh,off > fstart)

#### 10.4 REACTIVE POWER EXPLANATION

A growing share of power coming from PV installations results in a demand to keep the utility grid stable. Reactive power is an inverter function which helps to stabilize the utility grid. It enables adaptation of the power factor to reduce output power when there is more supply than demand.

SunMaster CS inverters can generate Reactive power as required by the VDE-AR-N 4105 regulations in Germany, which will be introduced 1 September 2011. These regulations state the following reactive power requirements:

Installation size	Power factor
<3.68 kVA	1.00
3.68-13.8 kVA	0.95
>13.8 kVA	0.90

A power factor of 0.9 means the power fed back is reduced by 10%. In other words: there is 90% active (useful) power and 10% reactive (useless) power. In this case, a 30 kVA inverter feeds 27 kW back into the grid.

Control for the reactive output can be adjusted to meet local demands. To calculate the effect of reactive power on the sizing of the installation, please download Mastervolts system calculator SysCalc which is available for free on [www.mastervoltsolar.com](http://www.mastervoltsolar.com). SysCalc takes into account the effects of reactive power on cable losses. Mastervolt inverters, if set to German country settings, will select default reactive power settings. For adjustment of these settings, refer to chapter 8.

#### 10.5 REACTIVE POWER MANAGEMENT

Reactive power is needed in some installations to support the local grid quality. A default configuration is programmed for each installation country that is compliant to the applicable national grid codes. In some cases, the local network operator (DNO) may require to adjust the inverter settings.

The SunMaster CS supports four different control laws, out of which one can be selected.



If the inverter is operating at an output power below 20% of its nominal rating, the Reactive Power output may deviate from the provided settings. This is normal behavior for the CS inverter.

The inverter can be set up to reduce the reactive power in four different ways:

1. Cos phi – P
2. Q – U
3. Constant cos-phi
4. Constant Q

#### 10.5.1 Power dependent power factor control

This control law (cos phi – P control) sets the phase angle between voltage and current as a function of the inverter output power. It is the default control loop selected for operation in Germany. Figure 10-8 shows an example demonstrating the available parameters.

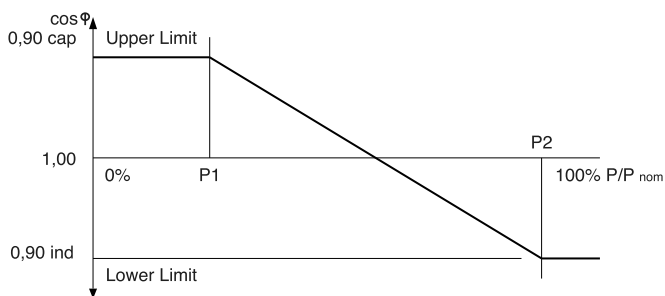

Figure 10-8: Cos phi – P Control

The user (installer) can provide 4 independent setpoints:

Name	Range	Resolution	Default
cos phi P1 (Upper Limit)	0,90 ind -> 0,90 cap*	0,01	1,00
cos phi P2 (Lower Limit)	0,90 ind -> 0,90 cap*	0,01	0,95 ind
Power Setpoint 1 (P1)	0% -> 100% P/ Pnom	1%	50%
Power Setpoint 2 (P2)	0% -> 100% P/ Pnom	1%	100%



cap = Capacitive generator (i.e. over-excited generator, current lags voltage)  
ind = Inductive generator (i.e. under-excited generator, current leads voltage)

P2 cannot be set to a value equal to or below P1 (P1 < P2); The Upper Limit cannot be set to a value below the Lower Limit.



### 10.5.2 Voltage dependent Q control

This control law (Q – U control) produces an amount of reactive power based on the actual grid voltage. Figure 10-9 shows an example demonstrating the available parameters.

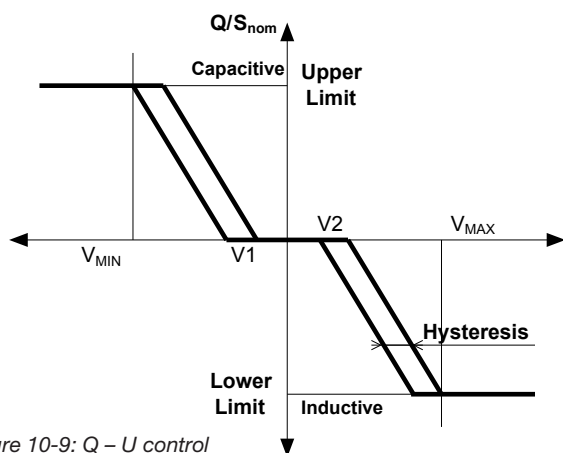

Figure 10-9: Q – U control

Name	Range	Resolution	Default Value
Upper Limit	53%ind–53%cap	1%	44% cap
Lower Limit	53%ind–53%cap	1%	44% ind
VMIN	184 – 264 V	0,1 V	184 V
VMAX	184 – 264 V	0,1 V	253 V
V1	184 – 264 V	0,1 V	230 V
V2	184 – 264 V	0,1 V	230 V
Hysteresis	0 – 100 V	0,1 V	0 V

The reactive power values for the Upper and Lower Limits are defined as a percentage of the nominal apparent inverter power (Snominal). For example, a value of 20% cap programmed in a CS20TL inverter, will correspond to  $20.000VA * 20\% = 4000var$

Removing the hysteresis is possible by programming the value to 0V. In case a hysteresis is provided, the V1 and V2 points will be centered inside width of the hysteresis. In figures 10-10 and 10-11, two possible configurations are shown with different parameters:

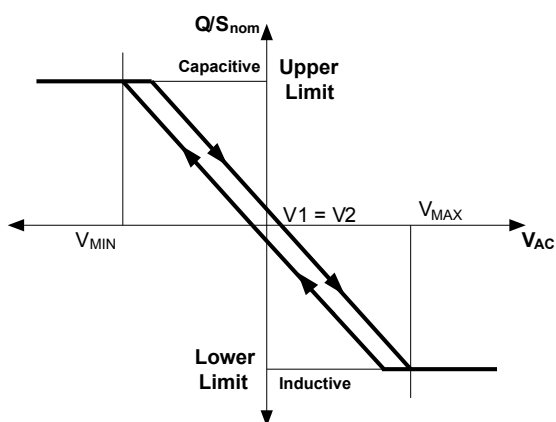

Figure 10-10: Example with  $V1 = V2$  and  $Hysteresis > 0V$

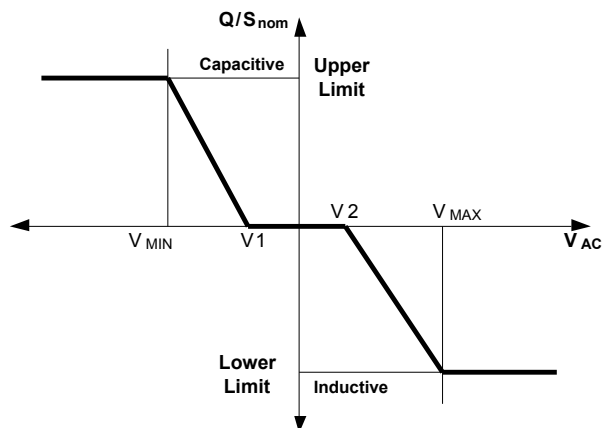

Figure 10-11: Example with  $Hysteresis = 0$

Refer to [www.mastervoltsolar.com](http://www.mastervoltsolar.com) for more information about reactive power.

### 10.5.3 Constant Power Factor output

It is possible to fix the inverter phase angle regardless of the output power by selecting the “Constant cos phi” control law. Any value between 0,90 ind and 0,90 cap can be selected.

### 10.5.4 Constant Reactive Power output

The “Constant Q” control law sets the inverter to generate a fixed amount of reactive power regardless of the inverter output power or the grid voltage. Like in the Q-U control law, the reactive power setting is defined as a percentage of the nominal apparent inverter power (Snominal).

### 10.5.5 Response Delay

The Response Delay determines how fast the inverter should respond to changes in the output power or in the grid voltage, if the “cos phi – P control” or “Q – U control” laws are used. A larger Response Delay setting will make the inverter respond slower.

## 10.6 USING AN ISOLATION TRANSFORMER

An isolation transformer may be necessary for several reasons:

1. To allow functional grounding of the PV array.
2. High Solar Array capacitance
3. Local regulations

### 10.6.1 Y-configuration

The secondary windings (on the inverter side) of the isolation transformer must be in Y (wye, star) configuration with a neutral connection available at the star point of the three windings. Refer to figure 10-12 for a simplified installation schematic.

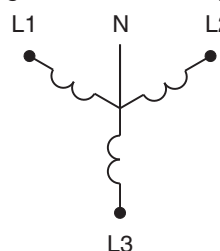

Figure 10-12: 3-ph isolation transformer in Y-configuration

**10.6.2 PV array earthing**

If the PV array is not grounded and local regulations require this, it is allowed to ground the neutral at the transformer side (TN network)

If the PV array is functionally earthed it is recommended to use a separate transformer for each inverter, or to use a transformer with multiple isolated windings.

**10.6.3 CS-IT20 transformers**

The CS-IT20 isolation transformer is designed to provide the necessary isolation for one CS20 inverter. It features a MasterBus controlled relay to switch off during the night, reducing night-time losses to a minimum

Figure 10-13 shows how the MasterBus network can be installed to a CS-IT20 transformer. MasterBus supports cable lengths up to 100m.

When installed, the CS inverter will automatically detect the transformer relay and load all appropriate settings. No user configuration is necessary to set up the transformer control.

If desired, the transformer control can be switched off in the display menu. Refer to section 8.9.2.2 for instructions.

**10.6.4 MasterBus connections**

The CS-IT20 transformer is equipped with a MasterBus relay for MasterBus controlled switching. Network A is used for this purpose. Refer to figure 5-7 and chapter 5.

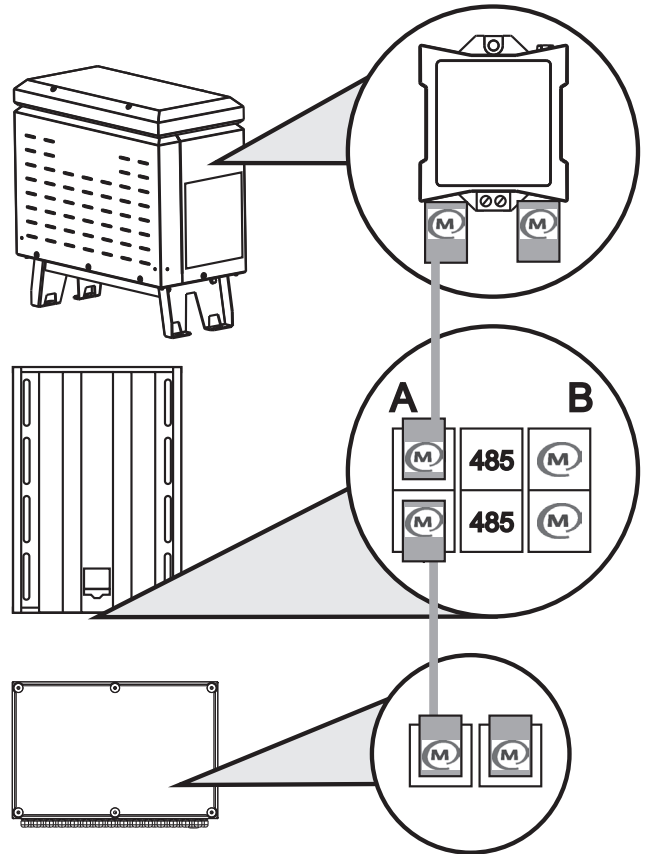

Figure 10-13: MasterBus network A: CS-IT20, CS20TL, CS30TL, StringMaster Pro

## 11 FUNCTIONAL GROUNDING

### 11.1 FUNCTIONAL GROUNDING

During normal operation, the CS inverter will balance the DC voltage on its terminals around the PE potential. This means the negative DC terminal will operate on a negative potential with respect to PE and vice versa for the positive DC terminal. Certain PV module types cannot withstand this balanced operation and may suffer accelerated degradation in case the array is left floating. In such a case, one of the DC terminals of the PV array must be grounded. This is called Functional Grounding. For more information, refer to [www.mastervoltsolar.com](http://www.mastervoltsolar.com).



The SunMaster CS inverter cannot operate when functionally grounded, unless an isolation transformer is used.



Protective grounding is not the same as functional grounding. The mechanical structure of the PV array should always be grounded. This also applies for the AC side of the CS inverter (see section 5.4)

### 11.2 INSTALLATION REQUIREMENTS

The CS inverter can support operation with functional grounding if the following conditions are satisfied:

- A suitable isolating power transformer such as CS-IT20 is installed.
- The secondary neutral terminal of the isolation transformer is NOT grounded.
- Both DC inputs are paralleled.
- The inverter PE terminals are always grounded.

Either the Positive or Negative DC terminal can be grounded. Refer to figure 11-2 for a SIMPLIFIED installation diagram.

### 11.3 INVERTER SETTINGS

When the installation is complete, the inverter can be commissioned according to the procedure described in section 5.6. After the initial start-up and first configuration steps, the inverter will report an insulation failure on the DC terminals. The inverter will not switch on.

1. On the CS inverter display, go to Configuration Page.
2. Enter the Installer Code.
3. Go to the Grid interface menu and select Options
4. The Options menu will show the isolation detection settings. Refer to section 8.9.2.3 for details.

Options		🕒 22:22
<b>Insulation</b>		
Function	[ On ]	
Rlimit	[ 550K ]	
Input1	890 Kohm	
Input2	789 Kohm	
<b>Isolation transformer</b>		
Night shutdown	[ On ]	

Figure 11-1: Isolation detection

5. Set the Function parameter to “Pos GND” or “Neg GND” depending on which DC terminal has been grounded. Push the OK button to confirm.
6. Adjust the Rlimit value to the lowest setting. Push the OK button to confirm.
7. The settings are now saved in the inverter memory. You can return to the Home Screen with the BACK button.

The inverter will now start up.

During every start-up from now on, the inverter will check the integrity of the functional grounding. If grounding has failed and the isolation resistance of the PV array is higher than the Rlimit threshold value, the inverter will issue an error message and remain in stand-by mode.

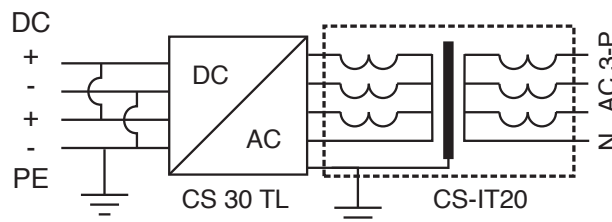

Figure 11-2: PE at DC input isolation transformer

### 11.4 MULTIPLE CS INVERTERS ON A SINGLE TRANSFORMER

If more than one inverter is connected to one transformer, the ground connections may cause the insulation detection to trip.

It is not recommended to install multiple CS inverters on a single transformer. Ground loops may occur and trigger the RCD protection in the inverter. Installations with multiple CS inverters requiring functional grounding can best apply a separate transformer for each inverter. Alternatively, a transformer with multiple isolated windings may be used.

## 12 TROUBLE SHOOTING

### 12.1 LED INDICATION AND SOLUTION TABLE

Fast blink= 2 blinks per second, slow blink = 1 blink per second

LED indication	Display indication	Description	What to do
No LED function	No display function	AC not connected and:	
		1. insufficient irradiation	If no display appears during daytime, contact your installer.
		2. DC switch in Off position	Move DC switch to the ON position.
		3. DC fuse blown	Check string fuses.
		4. No PV power (voltage out of range)	The DC voltage should be 200-1000V.
<b>Grid faults</b>			
Red	AC freq high, low	Grid frequency out of range	If this happens often, contact installer.
Red	AC phase jump	Disconnect: fast frequency fluctuations	If often, contact your installer.
Red	AC quality	Disconnect due to bad grid quality	If often, contact your installer.
Red	No grid	No grid available	Check the fuses.
Red	AC volt low, high	Grid voltage low, high	If often, contact your installer.
Red	TR AC volt high	Transient AC voltage high	If often, contact your installer.
Red	SL AC volt high	Grid voltage high for 10 minutes	If often, contact your installer.
Red A	C Phase Balance	Grid phase balance out of range	If often, contact your installer.
<b>Hardware faults</b>			
Red, fast blink	HW ...\....	Hardware problem	Contact your installer.
	HW insulation	Isolation fault. Resistance between DC and PE is too low.	Check the PE connections.
Red	Temperature high	Disconnect due to too high internal heat sink temperature	The inverter will start up again as soon as It has cooled down.
<b>Ambient faults</b>			
Red	Sol 1,2 high	Solar input 1 and/ or 2 over voltage (DC > 1000 V). Inverter may be damaged.	Check PV array open circuit voltage, check OVP in your StringMaster Contact your installer.
Red	Solar low	Solar 1 and 2 voltage low due to low irradiation. Inverter has shut down.	Check: string fuses, DC switch, DC cable. Wait till sunrise.
<b>Normal operation</b>			
Red, slow blink	Reclosure Time	Reclosure time counting	Nothing, reclosure may take 5 minutes.
White	ON, Derating	Power Reduction due to: 1. internal temperature, 2. fan failure (max. 75% load then), 3. DC voltage <350V or >800V, 4. Lower AC voltage.	Check the fan, MasterBus power setting and the voltages.
White	ON, Pwr Mgmt xx% xx ranges 100, 60, 30, 0	Power reduction by request of the grid operator (via DataControl Premium/ Pro II). Range 0% (no power), 30%, 60% and 100% (maximum power).	
White	ON, Sol1 Low , Sol2 Low	Solar input voltage 1 and/ or 2 low. The inverter is still operating.	Check the string fuses, DC switch if applicable, DC cable; wait till sunrise.
White	ON	Normal operation	
<b>StringMaster faults</b>			
	HW Error	Refer to StringMaster manual.	
	Not Connected	StringMaster has no connection to MasterBus. StringMaster has not been configured.	Check MasterBus cabling and MasterBus configuration.
	Warning.	Refer to section 8.7 for warning descriptions.	
	OC	Over current: Installation error	Check cabling and scheme.
	NEG	Reverse polarisation	Check string polarisation.
	LOW	Performance (current) low	Check fuse, cabling, irradiation of PV modules (shadows spoil the performance).
	OVP 1 (2)	Over Voltage Protection of Input 1 or 2	Check Input 1 or 2 varistor.

## 13 TECHNICAL SPECIFICATIONS

	CS15TL RP	CS20TL RP	CS30TL RP
<b>GENERAL SPECIFICATIONS</b>			
Operating temp.	Ambient temperature -20°C to 60°C (full power up to 45 °C. )		
Enclosure	Powder coated aluminum		
Protection degree	IP65 electronics for outdoor application		
Pollution degree	II		
Relative humidity	4 – 100% condensing.		
Operation altitude	2000m		
Safety class	Class I metal enclosure with protective earth		
Weight	65 kg (143 lbs)	65 kg (143 lbs)	75 kg (165 lbs)
Dimensions	See section 13.2	See section 13.2	See section 13.2
<b>SOLAR INPUT (DC)</b>			
Recommended PV power range	13 kWp – 19 kWp	18 kWp – 25 kWp	26 kWp – 38 kWp
Maximum input power	17 kW DC	22 kW DC	33 kW DC
Start up power	20 W	20 W	20 W
Operating voltage	200 V DC – 950 V DC	200 V DC – 950 V DC	200 V DC – 950 V DC
Nominal voltage	650 V DC	650 V DC	650 V DC
MPP voltage range @ nominal power	350-800 V DC	350-800 V DC	460-800 V DC
Absolute maximum voltage	1000 V DC	1000 V DC	1000 V DC
Maximum array capacitance	6 µF total for 2 inputs		
Number of inputs	2 MPP trackers / 2 inputs,		
Connectors	2 x 2 PV MultiContact	2 x 2 PV MultiContact	2 x 2 PV Phoenix Contact
Rated current	2 x 23 A (can be paralleled)	2 x 30 A (can be paralleled)	2 x 34 A (can be paralleled)
PV module safety qualification	The connected PV modules must be IEC 61730 Class A rated.		
String connections	Optional string box with DC switch, surge protection and string fuses available.		
<b>GRID OUTPUT (AC)</b>			
Voltage 230V	(3phase, 4 wire Y) +/- 20%		
Nominal power	15 kVA	20 kVA	30 kVA
Maximum power	15.75 kVA	21 kVA	31.5 kVA
Nominal current	3 x 24 A	3 x 32 A	3 x 46 A
Max. Inrush Current	28.2A		
Short circuit L-N	150A peak/	12.9A RMS(3 cycl)	during 8ms
Short circuit L-L	298A peak/	21.8A RMS (3 cycl)	during 4ms
Frequency	50 / 60 Hz		
Nominal power factor	> 0.99 at full power		
Reactive power control	0.80 inductive – 0.80 capacitive		
DC current injection	< 20 mA		
Harmonic distortion	< 3 % THD		
Stand by power	< 2 W		
EU efficiency	97.6 %	97.7 %	97.7 %
Maximum efficiency	98 %	98.1 %	98.1 %
Connector	3 Ph + N + PE ; IP67 3-phase AC plug		
Fuse	External fuses required		
<b>SAFETY DEVICES</b>			
Anti Islanding protection Compatible with national standards.			
Safety devices DC side	<ul style="list-style-type: none"> <li>isolation resistance measurement</li> <li>polarity protection (diodes)</li> <li>class III surge protection (varistors)</li> <li>overpower / overcurrent</li> <li>temperature controlled power derating</li> </ul>		
Safety devices AC side	<ul style="list-style-type: none"> <li>voltage / frequency window</li> <li>redundant AC relays</li> <li>integrated RCD (AC/DC sensitive), trip levels: 30 mA jump, 300 mA continuous</li> <li>DC current injection protection</li> <li>class III surge protection (varistors)</li> </ul>		

**SYSTEM INFORMATION**

User interface	Multi-language black-on-white graphical LCD display. Languages: English, Nederlands, Deutsch, Français, Castellano, Italiano
Diagnostics	<ul style="list-style-type: none"> <li>• 10 years datalogger and real time clock</li> <li>• 10 years diagnostic memory</li> </ul>
External communication	A: MasterBus stringbox and transformer interface with two connectors B: MasterBus field service interface with two connectors C: 2 RS485 connections for DataControl Professional, max. 20 inverters, 1000 m max. cable length
MasterBus powering	Yes, if AC and/or DC is available
MasterBus languages	English, Nederlands, Deutsch, Français, Castellano, Italiano, Norsk, Svenska, Suomi, Dansk *
<b>MISCELLANEOUS</b>	
Cooling	User replaceable fan bracket
Enclosure	Aluminium with powder coating. Rubber foot stands are part of the enclosure. Mounting bracket.
String box option	IP65 enclosure; Integrated DC load switch 2x1000V DC /30A; Integrated string fuses; Integrated string current monitoring via Masterbus connection to inverter; 12 (2 x 6) string connections with 4 mm type connectors or glands.
Transformer option	3-phase transformer in IP54 enclosure; Cooling: natural convection; Transformation losses : max 2% Weight 200 kg.

\* The number of menu languages may change without prior notice.

**13.2 OUTLINE DRAWINGS**

Figure 13-1:  
Outline drawings of the CS inverter.  
All dimensions are in mm (inch).

## 14 ORDERING INFORMATION

Part number	Description
131210150	SunMaster CS15TL RP with Reactive Power
131210200	SunMaster CS20TL RP with Reactive Power
131210300	SunMaster CS30TL RP with Reactive Power
131300500	SwitchMaster CS 2-3 SW 30 string box for maximum 2x3 strings.
131300600	SwitchMaster CS 2-3 SW 30 OVP, SwitchMaster plus overvoltage protection.
131300700	SwitchMaster CS 2-5 SW 40 OVP, max 2x5 strings plus overvoltage protection plus string fusing.
131300100	Isolation transformer CS-IT20
77040000	MasterBus terminating device
77040020*	MasterBus connection cable (UTP patch cable), 0,2m / 0.6ft
77040050*	MasterBus connection cable (UTP patch cable), 0,5m / 1.6ft
77040100*	MasterBus connection cable (UTP patch cable), 1,0m / 3.3ft
77030100	MasterBus - USB interface (required as interface between your PC and the CS inverter)
77010105	MasterView Easy MkII. (monitoring and control panel for configuration of the power modules with the local regulations for grid connection).
130394000	MasterLog – Free software package to monitor your photovoltaic (PV) system using your PC or notebook. Use of PC Link is compulsory.
130500610	USB PC Link
130397000	Data Control 'Premium' II local – Datalogger to monitor up to 6 CS inverters locally
130397100	Data Control 'Premium' II remote – Datalogger to monitor up to 6 CS inverters over the Internet
130397200	Data Control 'Pro' Analogue – Datalogger to monitor up to 20 CS inverters locally or over the Internet
130397210	Data Control 'Pro' ISDN – Datalogger to monitor up to 20 CS inverters locally or over the Internet
130397220	Data Control 'Pro' GSM – Datalogger to monitor up to 20 CS inverters locally or over the Internet
130397230	Data Control 'Pro' Ethernet – Datalogger to monitor up to 20 CS inverters locally or over the Internet
130010905	RS485 modular communication cable, cross wired, 8 pole, 1 meter / 3 ft
130010906	RS485 modular communication cable, cross wired, 8 pole, 5 meter / 16 ft
130010910	RS485 modular communication cable, cross wired, 8 pole, 10 meter / 33 ft
130010915	RS485 modular communication cable, cross wired, 8 pole, 15 meter / 49 ft
120107000	Complete set to assemble RS485 modular communication cables. Delivery includes: 100 meter modular cable, 100 pcs. modular jacks and crimping tool.

\*Other lengths of MasterBus connection cables upon request

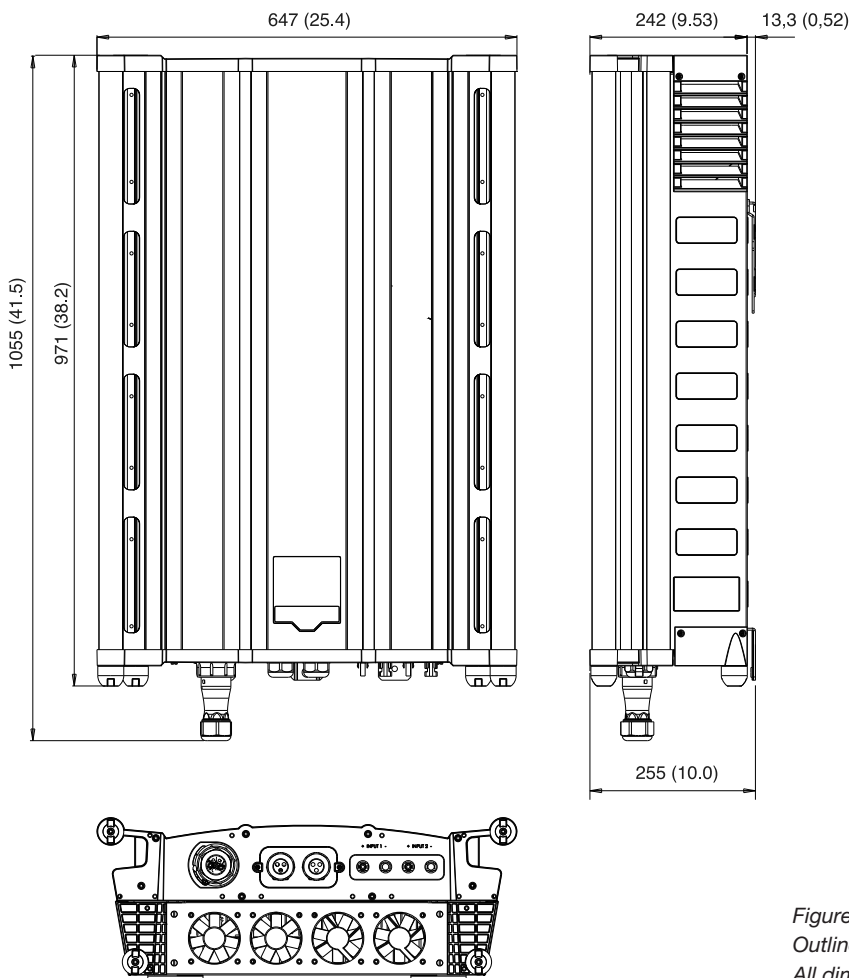
See chapter 5 for an overview of parts that are included with the delivery of the CS inverter. Mastervolt offers a wide range of products for both grid connected and independent autonomous electrical installations. See [www.mastervolt.com](http://www.mastervolt.com) for an extensive overview of all our products.

**15 CERTIFICATES****15.1 VDE AR N 4105 CERTIFICATE OF COMPLIANCE**

# Konformitätsnachweis

## Erzeugungseinheit

### NA-Schutz

**Antragsteller:** Mastervolt International B.V.  
 Snijdersbergweg 93  
 1105 AN Amsterdam  
 The Netherlands

**Produkt:** Photovoltaik Wechselrichter mit integriertem NA-Schutz

<b>Modell:</b>	<b>CS30TL RP</b>	<b>CS20TL RP</b>	<b>CS15TL RP</b>
<b>max. Scheinleistung <math>S_{E_{max}}</math>:</b>	<b>30,0kVA</b>	<b>20,0kVA</b>	<b>15,0kVA</b>
<b>Bemessungsspannung:</b>	<b>400/ 230Vac, 3ph/ N/ PE, 50Hz</b>		
<b>Software Version:</b>	<b>Red: 1.50V DSP: 1.60V</b>		

Die oben bezeichneten Erzeugungseinheiten mit integriertem NA-Schutz erfüllen die Anforderungen der VDE-AR-N 4105.

Die Funktionstüchtigkeit der Wirkungskette „NA-Schutz-Kuppelschalter“ unter den generellen Anforderungen der Einfehlersicherheit ist gegeben.

**Netzanschlussregel:****VDE-AR-N 4105:2011-08**

Erzeugungsanlagen am Niederspannungsnetz – Technische Mindestanforderungen für Anschluss und Parallelbetrieb von Erzeugungsanlagen am Niederspannungsnetz.

Ein repräsentatives Testmuster des oben genannten Erzeugnisses entspricht zum Zeitpunkt der Ausstellung dieser Bescheinigung der aufgeführten Netzanschlussregel.

**Berichtsnummer:** 11KFS109MAST-01

**Zertifikatsnummer:** 11-077-01

**Ausstelldatum:** 2012-05-16

**Gültig bis:** 2014-11-17

**Horst Haug**  
Zertifizierstelle



## 15.2 RD 1699 COMPLIANCE

## Certificado

**Solicitante:** Mastervolt International B.V.  
 Snijdersbergweg 93  
 1105 AN Amsterdam  
 The Netherlands

**Producto:** Inversor fotovoltaico

**Modelo:** CS15TL RP, CS20TL RP, CS30TL RP

Que los inversores de conexión a la red citados en este documento cumplen con la normativa española sobre conexión de instalaciones fotovoltaicas a la red de baja tensión.

En concreto cumplen con las funciones para seguridad de las personas y de la instalación mediante el empleo de técnicas equivalentes al aislamiento galvánico de un transformador, de acuerdo con el Real Decreto 1699/2011.

Los inversores incorporan una unidad de monitorización de corriente residual (en inglés RCMU: Residual Current Monitoring Unit), sensible a todas las corrientes de defecto que actúa con un umbral de respuesta de 30 mA. Los relés de corriente alterna desconectan de forma segura la red en caso de fallo. Dispone de vigilancia de aislamiento y control de puesta a tierra en el lado de tensión continua DC antes de la conexión a red. Estas funcionalidades han sido probadas y certificadas según la DIN V VDE V 0126-1-1:2006:02. La corriente continua inyectada en la red de distribución por el inversor es inferior al 0,5% del valor eficaz de la corriente nominal de salida, medida tal como indica la "Nota de interpretación de equivalencia de la separación galvánica".

El tiempo de reconexión de los inversores es de al menos 3 minutos conforme a la norma IEC 61727 una vez que los parámetros de la red vuelven a estar dentro de los márgenes permitidos.

Las funciones de protección para la interconexión de máxima y mínima frecuencia (50,5Hz y 48,0Hz, respectivamente) y de máxima y mínima tensión (fase 1  $U_n+10\%$ , fase 2  $U_n+15\%$  y  $U_n -15\%$ , respectivamente) están integradas en el equipo inversor, existiendo imposibilidad de modificar los valores de ajuste de las protecciones por el usuario mediante software.

Los equipos disponen de protección frente a funcionamiento en isla.

### Bases de certificación:

**RD 1699/2011 y DIN V VDE V 0126-1-1 (VDE V 0126-1-1):2006-02 y Nota de interpretación técnica de la equivalencia de la separación galvánica de la conexión de instalaciones generadoras en baja tensión.**

El concepto de seguridad de un producto representativo ya mencionado, corresponde en el momento de la emisión de este certificado de especificaciones válidas de seguridad para el empleo especificado conforme a reglamentaciones.

**Número de informe:** 11KFS109MAST-02

**Número de certificado:** 12-033-00

**Fecha:** 2012-05-24

**Valedero hasta:** 2015-05-24



Horst Haug

## 15.3 ENEL CERTIFICATE



**BUREAU  
VERITAS**

**Bureau Veritas Consumer  
Products Services  
Germany GmbH**

Businesspark A96  
86842 Türkheim  
Germania  
+ 49 (0) 40 740 41 - 0  
cps-tuerkheim@de.bureauveritas.com

## Dichiarazione di conformità

**NOME ORGANISMO  
CERTIFICATORE:** Bureau Veritas Consumer Products Services Germany GmbH  
ACCREDITAMENTO n° ZLS II6/G3933-1/8/09  
Rif. DIN EN 45011  
Data validità: 30-Giugno-2013

**OGGETTO:** GUIDA PER LE CONNESSIONI ALLA RETE ELETTRICA DI ENEL  
DISTRIBUZIONE, Ed. 2.1, Dicembre 2010  
REGOLE TECNICHE DI CONNESSIONE DI CLIENTI PRODUTTORI ALLE RETI  
ENEL IN BASSA TENSIONE

**TIPOLOGIA APPARATO A CUI SI RIFERISCE LA DICHIARAZIONE:**

DISPOSITIVO DI INTERFACCIA	PROTEZIONE DI INTERFACCIA	DISPOSITIVO DI CONVERSIONE STATICA	DISPOSITIVO DI GENERAZIONE ROTANTE
X	X	X	

**COSTRUTTORE:** Mastervolt International B.V.  
Snijdersbergweg 93  
1105 AN Amsterdam  
Paesi Bassi

<b>MODELLO:</b>	CS15TL RP	CS20TL RP
<b>POTENZA NOMINALE:</b>	15kW	20kW

**VERSIONE FIRMWARE:** DSP 1.50  
RED 1.30

**NUMERO DI FASI:** trifase  
**RIFERIMENTO:** Il dispositivo non è equipaggiato con trasformatore di isolamento a bassa frequenza.

**RIFERIMENTI DEI LABORATORI CHE HANNO ESEGUITO LE PROVE:**

Bureau Veritas Consumer Products Services Germany GmbH  
ACCREDITAMENTO n° ZLS II6/G3933-1/7/09  
Rif. DIN EN ISO/IEC 17025  
Data validità: 30-Giugno-2013

Esaminati i Fascicoli Prove n°11TH0291-ENELguide, emessi dal laboratorio  
Bureau Veritas Consumer Products Services Germany GmbH

Si dichiara che il prodotto indicato è conforme alle prescrizioni ENEL

**Numero di certificato:** U11-729

**Data di emissione:** 2011-08-25

Achim Hänchen  
**FIRMA RESPONSABILE**

## 15.4 BDEWLINK\_15.4.PNG



**BUREAU  
VERITAS**

**Bureau Veritas  
Consumer Products Services  
Germany GmbH**  
Businesspark A96  
86842 Türkheim  
Deutschland  
+ 49 (0) 4074041-0  
cps-tuerkheim@de.bureauveritas.com

Zertifizierungsstelle der BV CPS GmbH  
Akkreditiert nach EN 45011 -  
ISO / IEC 17011

## Einheitenzertifikat

**Hersteller:** Mastervolt International B.V.  
Snijdersbergweg 93  
1105 AN Amsterdam  
The Netherlands

Typ Erzeugungseinheit:	Solar Inverter	CS15TL RP	CS20TL RP	CS30TL RP
<b>Technische Daten:</b>	Nennscheinleistung:	15 kVA	20 kVA	30 kVA
	Nennwirkleistung:	15 kW	20 kW	30 kW
	Nennspannung:	400/230V, 3ph/N/PE		
	Nennfrequenz:	50 Hz		

**Firmwareversion** 1.70 (CS15TL RP, CS20TL RP)  
2.00 (CS30TL RP)

**Netzanschlussregel:** BDEW-Richtlinie „Erzeugungsanlagen am Mittelspannungsnetz“  
Richtlinie für Anschluss und Parallelbetrieb von Erzeugungsanlagen am  
Mittelspannungsnetz, 2008 und Ergänzung 1/2009, 7/2010 und 2/2011

**Mitgeltende Normen /** DIN EN 61400-21:2008;

**Richtlinien:** Technische Richtlinien: TR3 Rev. 22, TR4 Rev. 5, TR8 Rev. 5  
TransmissionCode 2007

Die oben bezeichnete Erzeugungseinheit wurde nach den, in der Netzanschlussregel referenzierten, technischen Richtlinien geprüft und zertifiziert. Die in der Netzanschlussregel geforderten elektrischen Eigenschaften werden erfüllt:

- Erzeugung und Regelung von Wirk- und Blindleistung
- Verhalten der Erzeugungseinheit bei Netzstörungen (Blindstromcharakteristik gemäß TransmissionCode 2007)
- Schutzeinrichtung auf Einheitenenebene\*
- Ausweis der Netzurückwirkungen
- Validiertes Einheitenmodell: Mast\_12\_028\_TR4\_CS15TLRP\_V3  
Mast\_12\_028\_TR4\_CS20TLRP\_V3  
Mast\_12\_028\_TR4\_CS30TLRP\_V1

Der Hersteller hat die Zertifizierung seines Qualitätsmanagementsystems nach ISO 9001 nachgewiesen.

\* Eine erforderliche Prüfklemmleiste ist separat an einer übergeordneten Schutzeinrichtung zu verwirklichen.

### Das Zertifikat beinhaltet folgende Angaben:

- Technische Daten der Erzeugungseinheit, der eingesetzten Hilfseinrichtungen und der verwendeten Softwareversion
- Den schematischen Aufbau der Erzeugungseinheit
- Zusammengefasste Angaben zu den Eigenschaften der Erzeugungseinheit

**BV Projektnummer:** 11TH0291

**Zertifikatsnummer:** 12-028\_1

**Ausstellungsdatum:** 2012-06-22

**Gültig bis:** 2017-04-01

Zertifizierungsstelle

Dieter Zitzmann

(Eine auszugsweise Darstellung des Zertifikats bedarf  
der schriftlichen Genehmigung der BV CPS GmbH)



D-ZE-12024-01-01

**15.5 EC DECLARATION OF CONFORMITY**

*The undersigned,*

Mastervolt International B.V.  
Snijdersbergweg 93, 1105AN  
P.O box 22947 1100DK  
Amsterdam  
The Netherlands  
Tel: +31-(0)20-3422100  
Fax: +31-(0)20-6971006



*being the manufacturer, declares under his sole responsibility that the electronic equipment:*

*Product group: Solar Inverter*

*Brand: MASTERVOLT*

*Product type: SunMaster CS15TL\_RP, SunMaster CS20TL\_RP, SunMaster CS30TL\_RP*

*to which this declaration relates, are in conformity with the essential requirements and other relevant provisions of the Electro Magnetic Compatibility Directive 2004/108/EG and the Low Voltage Directive 2006/95/EG and carries the CE mark accordingly. The following harmonized standards were applied:*

Electromagnetic compatibility	IEC 61000-6-4:2006
	EN61000-3-11:2000
	EN61000-3-12:2004
	IEC 61000-6-2:2005
	IEC61000-4-2:2008
	IEC61000-4-3:2010
	IEC61000-4-4:2004
	IEC61000-4-5:2005
	IEC61000-4-6:2008
	IEC61000-4-8:2009
	Electrical safety
	IEC62109-2:2011 (LVD)

*This declaration will be void in case of unrightful use or unprofessional installation of the equipment.*

Amsterdam, 4-8-2011  
MASTERVOLT INTERNATIONAL B.V.

Ing. D.R. Bassie  
Product Manager Solar