



PV Inverter

# **SUNNY MINI CENTRAL 6000TL / 7000TL / 8000TL**

**Installation Guide**





# Table of Contents

<b>1</b>	<b>Notes on this Manual.</b> . . . . .	<b>7</b>
1.1	Scope of Validity. . . . .	7
1.2	Target Group . . . . .	7
1.3	Additional Information . . . . .	7
1.4	Symbols Used . . . . .	8
<b>2</b>	<b>Safety</b> . . . . .	<b>9</b>
2.1	Appropriate Usage. . . . .	9
2.2	Safety Precautions. . . . .	11
2.3	Explanation of Symbols . . . . .	12
2.3.1	Symbols on the Inverter. . . . .	12
2.3.2	Symbols on the Type Label . . . . .	13
<b>3</b>	<b>Unpacking.</b> . . . . .	<b>14</b>
3.1	Scope of delivery . . . . .	14
3.2	Identifying the Inverter . . . . .	15
<b>4</b>	<b>Mounting.</b> . . . . .	<b>16</b>
4.1	Safety . . . . .	16
4.2	Selecting the Mounting Location. . . . .	16
4.3	Mounting the Inverter with Wall Mounting Bracket . . . . .	18
<b>5</b>	<b>Electrical Connection</b> . . . . .	<b>21</b>
5.1	Overview of the Connection Area . . . . .	21
5.1.1	Exterior View. . . . .	21
5.1.2	Interior View . . . . .	22
5.2	Connection to the public grid (AC). . . . .	23
5.2.1	Conditions for the AC Connection . . . . .	23
5.2.2	Connecting the Inverter to the Public Grid (AC) . . . . .	26
5.2.3	Additional Grounding of the Enclosure. . . . .	28

5.3	Setting the Display Language . . . . .	29
5.4	Connection of the PV Generator (DC) . . . . .	30
5.4.1	Conditions for the DC Connection . . . . .	30
5.4.2	Assembling the DC Plug Connectors. . . . .	31
5.4.3	Opening the DC Plug Connectors. . . . .	33
5.4.4	Connecting the PV Generator (DC) . . . . .	34
5.5	Connection of the SMA Power Balancer . . . . .	37
5.5.1	Configuration . . . . .	37
5.5.2	Cabling . . . . .	41
5.5.3	Testing the Functioning . . . . .	44
5.6	Communication . . . . .	44
5.7	Setting the Grid and Country Parameters . . . . .	45
5.7.1	Setting the Installation Country . . . . .	45
5.7.2	Setting Stand-alone Grid Operation . . . . .	45
<b>6</b>	<b>Commissioning . . . . .</b>	<b>46</b>
6.1	Commissioning the Inverter. . . . .	46
6.2	Self-Test in accordance with DK 5940, Ed. 2.2 (applies to Italy only) . . . . .	47
6.2.1	Starting the Self-Test by Tapping. . . . .	47
6.2.2	Completion of the Self-Test . . . . .	47
<b>7</b>	<b>Opening and Closing. . . . .</b>	<b>52</b>
7.1	Safety . . . . .	52
7.2	Opening the Inverter. . . . .	52
7.3	Closing the Inverter. . . . .	55
<b>8</b>	<b>Maintenance and Cleaning. . . . .</b>	<b>57</b>
8.1	Checking Heat Dissipation . . . . .	57
8.1.1	Cleaning the Fans . . . . .	57
8.1.2	Checking the Fans. . . . .	58
8.1.3	Cleaning the Air Grills. . . . .	59

8.2	Checking the Electronic Solar Switch (ESS) for Wear . . . . .	60
<b>9</b>	<b>Failure Search. . . . .</b>	<b>61</b>
9.1	Blink Codes. . . . .	61
9.2	Error Messages. . . . .	61
9.3	Red LED is Glowing Continuously. . . . .	68
9.3.1	Checking the PV Generator for a Ground Fault . . . . .	68
9.3.2	Checking the Functioning of the Varistors . . . . .	69
<b>10</b>	<b>Decommissioning . . . . .</b>	<b>72</b>
10.1	Dismantling the Inverter. . . . .	72
10.2	Packing the Inverter. . . . .	73
10.3	Storing the Inverter . . . . .	73
10.4	Disposing of the Inverter . . . . .	73
<b>11</b>	<b>Technical Data . . . . .</b>	<b>74</b>
11.1	Sunny Mini Central 6000TL . . . . .	74
11.2	Sunny Mini Central 7000TL . . . . .	78
11.3	Sunny Mini Central 8000TL . . . . .	81
<b>12</b>	<b>Accessories . . . . .</b>	<b>84</b>
<b>13</b>	<b>Contact . . . . .</b>	<b>85</b>



# 1 Notes on this Manual

## 1.1 Scope of Validity

This manual describes the assembly, installation, commissioning and maintenance of the following SMA inverters:

- Sunny Mini Central 6000TL (SMC 6000TL)
- Sunny Mini Central 7000TL (SMC 7000TL)
- Sunny Mini Central 8000TL (SMC 8000TL)

Store this manual where it can be accessed at all times.

## 1.2 Target Group

This manual is for qualified personnel.. The tasks described in this manual may only be performed by qualified personnel.





## 1.3 Additional Information

You will find further information on special topics such as designing a line circuit breaker or the description of the operating parameters in the download area at [www.SMA.de/en](http://www.SMA.de/en).

Refer to the user manual for detailed information on operating the inverter.

## 1.4 Symbols Used

The following types of safety precautions and general information are used in this manual:

	<b>DANGER!</b>
<p>"DANGER" indicates a hazardous situation which, if not avoided, will result in death or serious injury.</p>	
	<b>WARNING!</b>
<p>"WARNING" indicates a hazardous situation which, if not avoided, could result in death or serious injury.</p>	
	<b>CAUTION!</b>
<p>"CAUTION" indicates a hazardous situation which, if not avoided, could result in minor or moderate injury!</p>	
	<b>NOTICE!</b>
<p>"NOTICE" indicates a situation that can result in property damage, if not avoided.</p>	
	<b>Information:</b>
<p>Information provides tips that are valuable for the optimal installation and operation of your product.</p>	
<input checked="" type="checkbox"/>	This symbol indicates the result of an action.



## 2 Safety

### 2.1 Appropriate Usage

The Sunny Mini Central is a PV inverter, which converts the DC current of the PV generator to AC current and feeds it into the public grid.

#### Operating Principle of a PV System with Sunny Mini Central

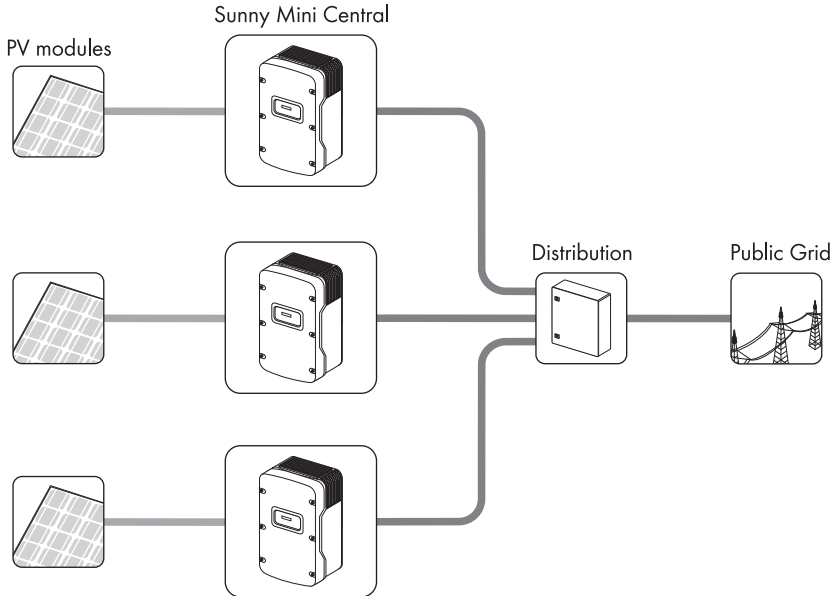

The Sunny Mini Central may only be operated with PV generators (modules and cabling) of protection class II. Do not connect any sources of energy other than PV modules to the Sunny Mini Central.



#### Capacitive Discharge Currents

PV modules with large capacities relative to ground, such as thin-film modules with cells on a metallic substrate, are only to be implemented if their coupling capacity does not exceed 1400 nF.

During grid feeding, a discharge current flows from the cells to ground. The amount of current depends on the manner in which the modules are installed (e.g. foil on metal roof) and on the weather (rain, snow). This "normal" discharge current may not exceed 50 mA due to the fact that the inverter would otherwise automatically disconnect from the grid as a protective measure. For further information on this subject, see the technical information "Capacitive Discharge Currents" in the download area at [www.SMA.de/en](http://www.SMA.de/en).

When designing the PV system, ensure that the values comply with the permitted operating range of all components at all times. The free design program "Sunny Design" ([www.SMA.de/en/SunnyDesign](http://www.SMA.de/en/SunnyDesign)) will assist you. The manufacturer of the PV modules must have approved the modules for use with this Sunny Mini Central unit. You must also ensure that all measures recommended by the module manufacturer for long-term maintenance of the module properties are taken (see also Technical Information "Module Technology", in the download area of [www.SMA.de/en](http://www.SMA.de/en)).

Do not use the inverter for purposes other than those described here. Alternative uses, modifications to the inverter or the installation of components not expressly recommended or sold by SMA Solar Technology AG void the warranty claims and operation permission.

## Certified Countries

The Sunny Mini Central 6000TL / 7000TL / 8000TL (with according configuration) fulfill the requirements specified in the following standards and directives (dated: March/2010):

- VDE 0162-1-1 (02.2006)
- C10/C11 (05.2009) \*
- PPDS
- PPC (02.2006)
- RD 1663/2000 (2000) \*\*
- SS-EN 50438
- AS4777 (2005)
- IEC utility Meeting 216
- DK 5940 Ed. 2.2 (02.2006) (only applies to SMC 6000TL-IT / 7000TL-IT / 8000TL-IT)
- Kepco guide (02.2006) (only applies to SMC 8000TL-KR)

\* Only possible when the phase voltage is 220 V.

\*\* In the event of restrictions in certain regions, contact the SMA Serviceline

SMA Solar Technology AG can preset special grid parameters for other countries / installation locations according to customer requests, after evaluation by SMA Solar Technology AG. You can make later modifications yourself by changing software parameters with respective communication products (e.g. Sunny Data Control or Sunny Explorer) (see section 5.7 "Setting the Grid and Country Parameters" (page 45)). To change grid-relevant parameters, you need a personal access code - the so-called SMA Grid Guard Code. The application form for the personal access code is located in the download area at [www.SMA.de/en](http://www.SMA.de/en), in the "Certificate" category for each inverter.

## 2.2 Safety Precautions



### DANGER!

Danger to life due to high voltages in the inverter.

- All work on the inverter must be carried out by qualified personnel only.
- The appliance is not to be used by children or persons with reduced physical, sensory or mental capabilities, or lack of experience and knowledge, unless they have been given supervision or instruction.
- Children should be supervised to ensure that they do not play with the appliance.



### DANGER!

Danger of burn injuries due to hot enclosure parts.

- Do not touch enclosure during operation.
- Only touch the lid during operation.



### NOTICE!

**Foreign objects or water entering the inverter can damage the device!**

Once the Electronic Solar Switch has been pulled out, the inverter only provides protection rating IP21. The inverter is then no longer protected against water and foreign objects. In order to keep the protection rating IP65 during temporary decommissioning, proceed as follows:

- Unlock and disconnect all DC connectors.
- Open all DC connectors and remove the wires.
- Close all DC inputs with the corresponding DC connectors and the sealing plug provided.
- Securely attach the Electronic Solar Switch again.







### Grounding the PV Generator

Comply with the local requirements for grounding the modules and the PV generator. SMA Solar Technology AG recommends connecting the generator frame and other electricity-conducting surfaces such that there is continuous conduction and to connect them to the ground in order to reach maximum protection for property and persons.







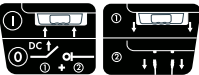



## 2.3 Explanation of Symbols

This chapter contains an explanation of all symbols found on the inverter and type label.

### 2.3.1 Symbols on the Inverter

Symbol	Explanation
	Operation display. Indicates the operation condition of the inverter.
	Ground fault or varistor defective. Read section 9.3 "Red LED is Glowing Continuously" (page 68).
	Disturbance or fault Read section 9 "Failure Search" (page 61).
	Tap to switch on the display light and switch to the next display message.
	Electronic Solar Switch (ESS) DC load disconnection unit <ul style="list-style-type: none"> <li>❶ When the Electronic Solar Switch is plugged in, the DC circuit is closed.</li> <li>❷ To interrupt the DC circuit and disconnect the inverter securely under load, you have to first pull out the Electronic Solar Switch ❶ and then remove all DC plug connectors ❷, as described in section 7.2 "Opening the Inverter" (page 52).</li> </ul>

## 2.3.2 Symbols on the Type Label

Symbol	Explanation
	Beware of dangerous electrical voltage. The inverter operates at high voltages. All work on the inverter must be carried out by qualified personnel only.
	Beware of hot surface. The inverter can become hot during operation. Avoid contact during operation.
	Observe all documentation that accompanies the inverter.
	The inverter must not be disposed of with the household waste. For more information on disposal, see section 10.4 "Disposing of the Inverter" (page 73).
	CE mark. The inverter complies with the requirements of the applicable EC guidelines.
	The inverter is transformerless.
	Direct Current (DC)
	Alternating current (AC)
	Protection rating IP65. The inverter is protected against penetration by dust particles and water jets from any angle.
	RAL quality mark for solar products. The inverter complies with the requirements of the German Institute for Quality Assurance and Labeling.

### 3 Unpacking

#### 3.1 Scope of delivery

Check the delivery for completeness and any visible external damage. Contact your dealer if anything is damaged or missing.

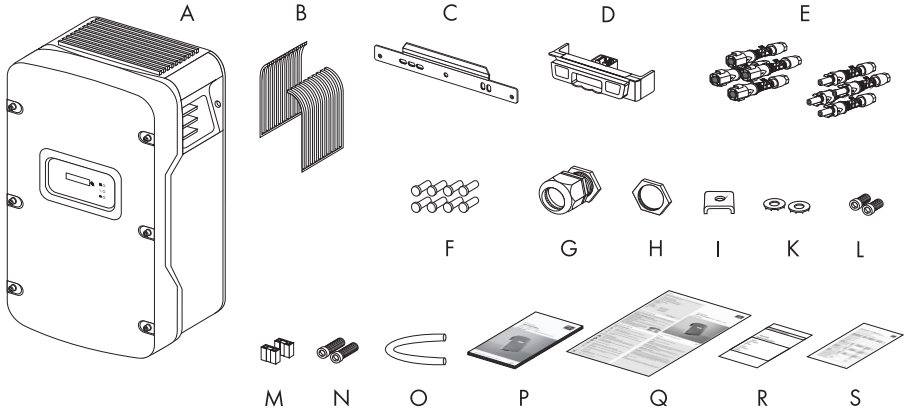

Object	Quantity	Description
A	1	Sunny Mini Central
B	1	Air grills (right / left)
C	1	Wall mounting bracket
D	1	Electronic Solar Switch (ESS) DC load disconnection unit
E	8	DC plug connectors (4 x positive / 4 x negative)
F	8	Sealing plugs for DC plug connectors
G	1	Cable gland for AC connection:
H	1	Counter nut for cable gland at AC connection
I	1	Clamping clip for additional grounding
K	2	Tooth lock washers: 1 x for cover screws (replacement), 1 x for ground connection cable terminal
L	2	Cylinder head screws (M6x16): 1 x for lid (replacement), 1 x for ground connection cable terminal
M	2	Jumper (1x for fan test 1x for the cabling of the SMA Power Balancer)
N	2	Cylinder head screws (M6x8) for securing the inverter to the wall mounting bracket
O	1	Silicone tube for insulating the SMA Power Balancer connection cable
P	1	Installation Guide
Q	1	User Manual

Object	Quantity	Description
R	1	Set of documents with explanations and certificates
S	1	Supplementary sheet with inverter factory settings

## 3.2 Identifying the Inverter

You can identify the inverter by the type label. The type label is on the right side of the enclosure.

The serial number (Serial no.) and the type (Type / Model) of the product, as well as device-specific characteristics are specified on the type label.

## 4 Mounting

### 4.1 Safety

**DANGER!**  
 Danger to life due to fire or explosion!

Despite careful construction, electrical devices can cause fires.

- Do not mount the inverter on flammable construction materials.
- Do not mount the inverter in areas where highly flammable materials are stored.
- Do not mount the inverter in areas with a risk of explosion.

**CAUTION!**  
 Danger of burn injuries due to hot enclosure parts.

- Mount the inverter in such a way that it cannot be touched inadvertently.

**CAUTION!**  
 Risk of injury due to the heavy weight of the inverter.

- Take the inverter's weight of approx. 33 kg into account for mounting.

### 4.2 Selecting the Mounting Location

Consider the following points when selecting where to install:

- The installation method and mounting location must be suitable for the inverter's weight and dimensions (see section 11 "Technical Data" (page 74)).
- Mount on a solid surface.
- The mounting location must at all times be clear and have safe access without the use of additional aids such as scaffolding or lifting platforms. Any possible service actions are otherwise limited.

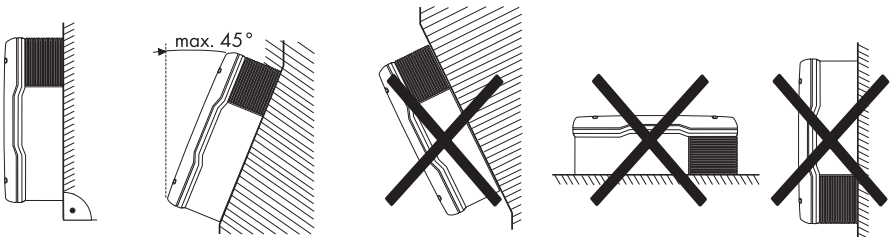

- Vertical installation or tilted backwards by max. 45°.
- The connection area must point downward.



- Never install the device with a forward tilt.
- Do not install horizontally.
- Install at eye level to allow operating modes to be read at all times.
- The ambient temperature should be below 40 °C to ensure optimal operation.
- Do not expose the inverter to direct sunlight to avoid a power reduction due to excessive heating.
- In living areas, do not mount the unit on plasterboard walls or similar in order to avoid audible vibrations. The inverter can make noises when in use which may be perceived as a nuisance in a living area.
- Observe the minimum clearances to walls, other inverters, or objects as shown in the diagram in order to guarantee sufficient heat dissipation and to have enough space for removing the Electronic Solar Switch.

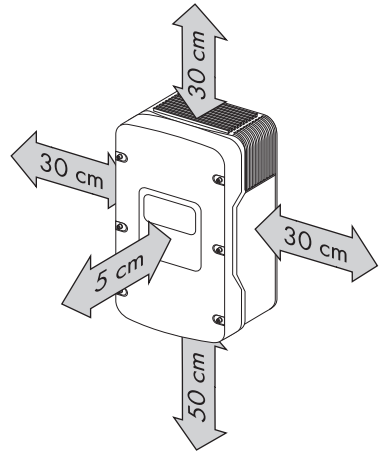

### Multiple inverters installed in areas with high ambient temperatures

There must be sufficient clearance between the individual inverters to ensure the cooling air from the adjacent inverter flows freely.

If necessary, increase the clearances and make sure there is enough ventilation to ensure sufficient cooling of the inverters.

### 4.3 Mounting the Inverter with Wall Mounting Bracket

1. Mark the position of the drill holes using the wall mounting bracket and drill the holes. Use at least 2 of the 6 holes, with one hole on the right and one on the left.

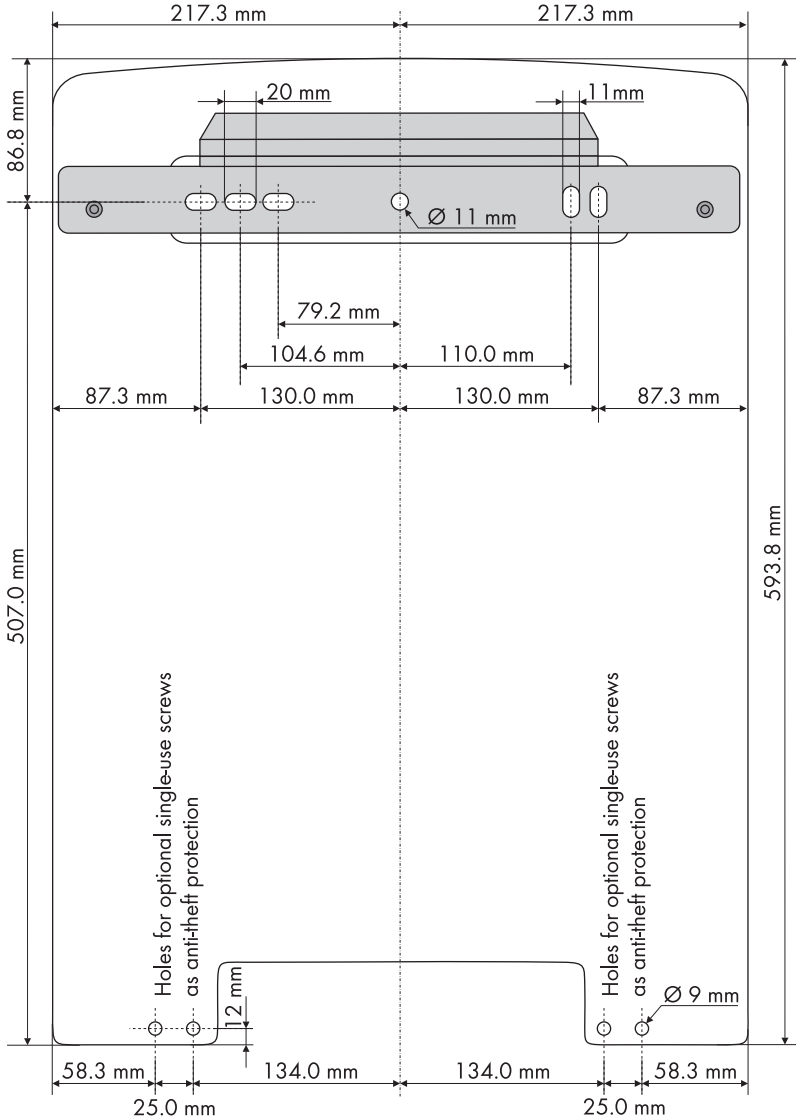

**CAUTION!**

**Risk of injury due to the heavy weight of the inverter.**

The inverter weighs approx. 33 kg.

- Attach the wall mounting bracket with the corresponding mounting material (depending on the surface).
- Use the side handles (above and below) or a steel rod (maximum diameter of 30 mm) for transport and mounting. The rod must be pushed through the enclosure openings.

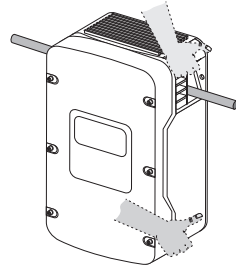

2. Secure the wall mounting bracket to the wall using appropriate screws and washers.

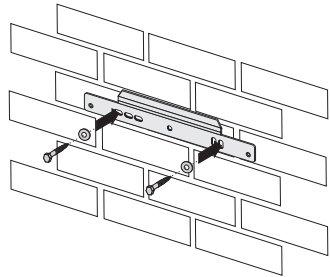

3. Using the mounting hole, attach the inverter to the rear panel of the enclosure in the wall mounting bracket.

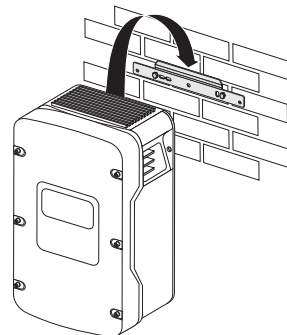

4. Screw the inverter to the wall mounting bracket on both sides using the screws (M6x8) provided.  
Only tighten the screws hand-tight.

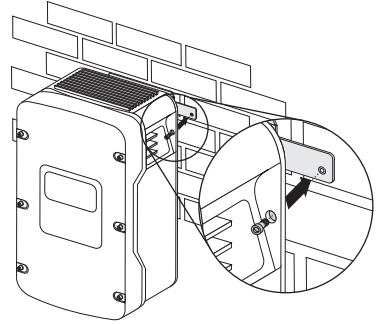

5. Check to ensure the inverter is firmly fastened.
6. Close the recessed grips with the air grills provided. The air grills are marked "rechts/right" and "links/left" on the interior for proper assignment.

The air grills prevent dirt and insects from entering the device and, if necessary, can be reordered from SMA Solar Technology AG (see section 13 "Contact" (page 85))

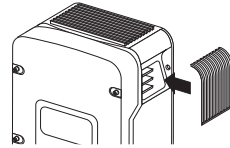

**Optional Theft Protection**

To protect the inverter against theft, the rear panel can be secured to the wall at the bottom using 2 single-use bolts.

The other two holes are spares.

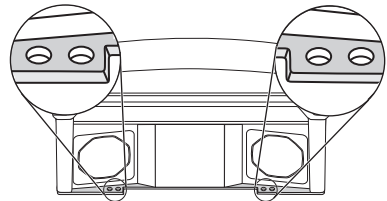

## 5 Electrical Connection



**NOTICE!**

**Electrostatic discharges can damage the inverter!**

Internal components of the inverter can be irreparably damaged by static discharge.

- Ground yourself before touching a component.

### 5.1 Overview of the Connection Area

#### 5.1.1 Exterior View

The following figure shows the assignment of the individual connection areas on the bottom of the inverter.

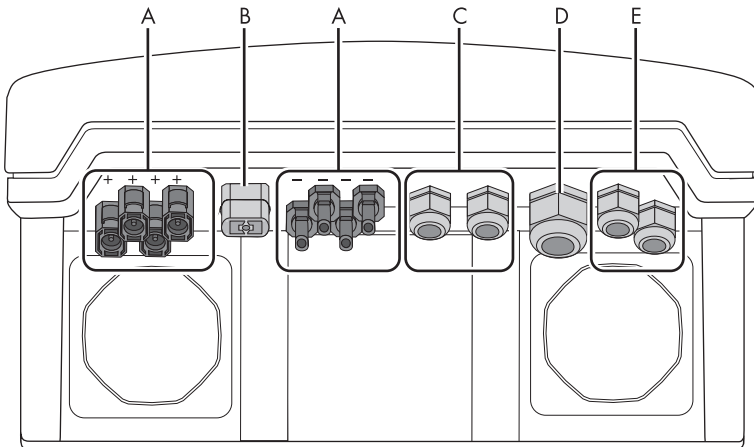

Object	Description
<b>A</b>	DC connectors for connecting the PV strings
<b>B</b>	Socket for connecting the Electronic Solar Switch (ESS) DC load disconnection unit
<b>C</b>	Cable gland for optional communication via RS485 (PG16)
<b>D</b>	Cable gland for grid connection (AC) (12 mm ... 25 mm)
<b>E</b>	Cable glands for SMA Power Balancer

### 5.1.2 Interior View

The following illustration shows the various components and connection areas of the open inverter.

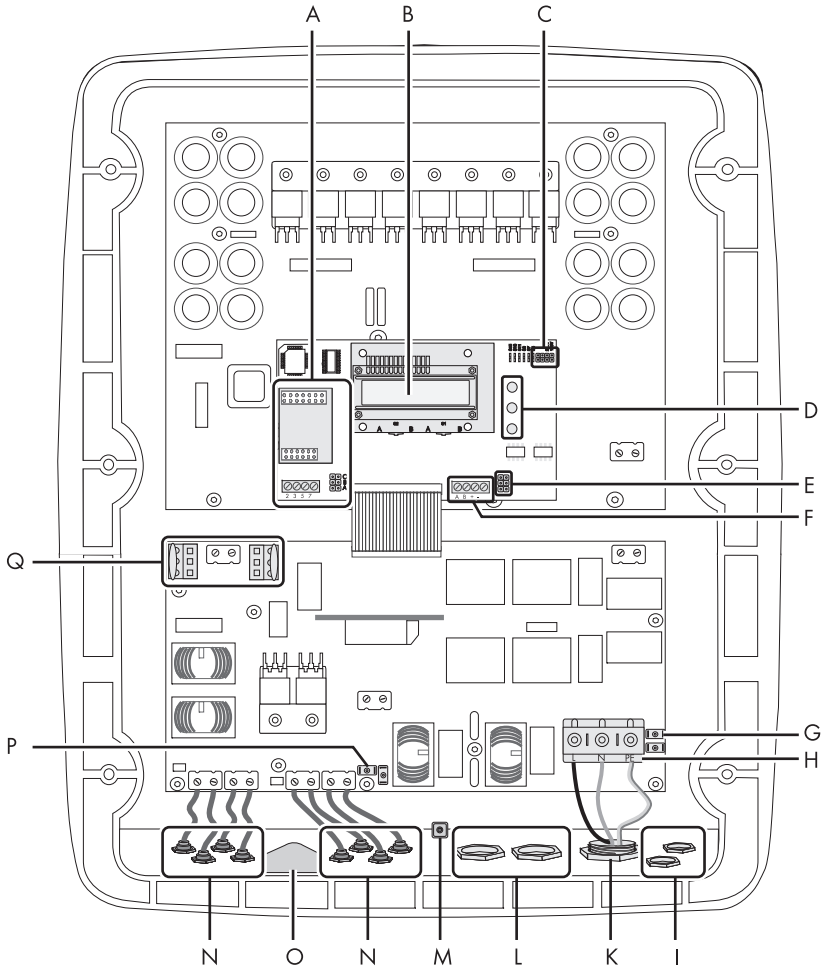

Object	Description
<b>A</b>	Connection area and sockets for communication (page 44)
<b>B</b>	Display
<b>C</b>	Jumper for testing the fans (page 58)
<b>D</b>	LEDs for displaying the operating modes (page 46)
<b>E</b>	Jumper for SMA Power Balancer (page 37)

Object	Description
F	Connections terminals for SMA Power Balancer (page 37)
G	Flat connector for grounding the cable shield when connecting the SMA Power Balancer (page 37)
H	Connection terminals for mains cable (AC) (page 23)
I	Cable glands for the SMA Power Balancer (page 37)
K	Cable gland for grid connection (AC) (page 23)
L	Cable gland for communication (page 44)
M	Screwing device of shield clamp for communication cable (page 44)
N	DC connectors (page 30)
O	Connection socket for "Electronic Solar Switch (ESS)" DC load disconnection unit (page 30)
P	Male connector for grounding the cable shield for communication (page 44)
Q	Varistors (page 69)

## 5.2 Connection to the public grid (AC)

### 5.2.1 Conditions for the AC Connection



#### Connection requirements of the utility operator

Always observe the connection requirements of your utility operator!

#### Cable Sizing

The conductor cross-section should be dimensioned in a way that output losses do not exceed 1 % at nominal power. Use "Sunny Design" ([www.SMA.de/en/SunnyDesign](http://www.SMA.de/en/SunnyDesign)) for this.

The maximum cable lengths relative to the conductor cross-section are shown in the following table.

Conductor cross-section	Maximum cable length		
	SMC 6000TL	SMC 7000TL	SMC 8000TL
10.0 mm <sup>2</sup>	25 m	22 m	19 m
16.0 mm <sup>2</sup>	41 m	35 m	31 m



#### Cut line losses in half

If three inverters with symmetrical feeding are combined to form a three-phase system, the neutral conductor is not subjected to any load, and the line losses are halved. Thus, the maximum possible cable length is doubled.

The conductor cross-sectional area required in individual cases depends on the following factors among others:

- Ambient temperature,
- Routing method,
- UV resistance.

## Cable Requirements

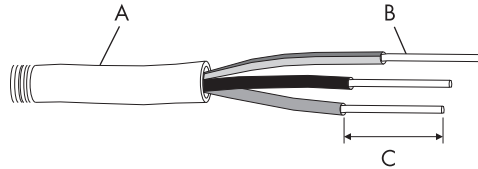

Position	Description	Value
A	External diameter	12 mm ... 25 mm
B	Conductor cross-section	10 mm <sup>2</sup> ... 16 mm <sup>2</sup>
C	Strip insulation	Approx. 16 mm

## Load Disconnection Unit

You must install a **separate** line circuit breaker for each inverter in order to ensure that the inverter can be securely disconnected under load. The maximum permissible rating is located in section 11 "Technical Data" (page 74).

Detailed information and examples for the rating of a line circuit breaker can be found in the Technical Information "Line Circuit Breaker" in the SMA Solar Technology AG download area at [www.SMA.de/en](http://www.SMA.de/en).



**DANGER!**  
Danger to life due to fire.

When more than one inverter is connected to the same line circuit breaker, the protective function of the line circuit breaker is no longer guaranteed. It can result in a cable fire or the destruction of the inverter.

- Never connect several inverters to the same line circuit breaker.
- Comply with the maximum permissible fuse protection of the inverter when selecting the circuit breaker.



**DANGER!**

**Danger to life due to fire.**

When a generator (inverter) and a consumer are connected to the same line circuit breaker, the protective function of the line circuit breaker is no longer guaranteed. The current from the inverter and the grid can accumulate to overcurrent, which is not detected by the line circuit breaker.

- Never connect loads between the inverter and the line circuit breaker without protection.
- Always protect consumers separately.

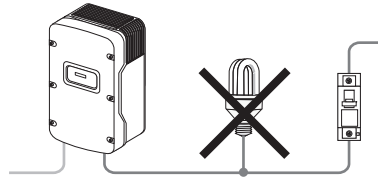
**NOTICE!**

**Damage to the inverter by using screw type fuse elements as a load disconnection unit!**

A screw type fuse element, e.g. D system (Diazed) or DO system (Neozed) is not a load disconnection unit, and thus may **not** be used as a load disconnection unit. A screw type fuse element is only used as cable protection.

When disconnecting under load using a screw type fuse element, the inverter can be damaged.

- Use only a load disconnecting switch or a line circuit breaker as a load disconnecting unit.

## 5.2.2 Connecting the Inverter to the Public Grid (AC)

1. Check the grid voltage and compare with " $V_{AC\ nom}$ " on the type label.  
The exact operating range of the inverter is specified in the operating parameters. The corresponding document is available in the download area at [www.SMA.de/en](http://www.SMA.de/en).
2. Switch off the line circuit breaker and secure it to prevent it from being reactivated.
3. Loosen all cover screws and remove the cover.

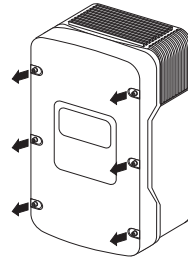

4. Remove tape on the AC enclosure opening (see "D" on page 21).
5. Insert the AC screw clamp into the enclosure opening from the outside and tighten it with the counter nut from the inside.
6. Pull the cable through.
7. Connect L, N and the protective conductor (PE) to the terminal blocks using a screwdriver in accordance with the label.

To do this, the PE wire must be 5 mm longer than the L and N wires!

L and N must not be swapped.

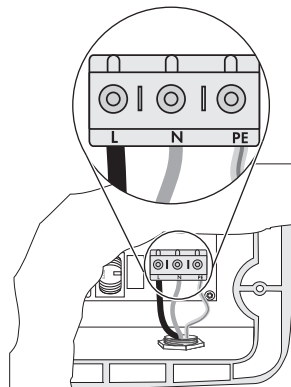

8. Securely close the gland on the enclosure opening.

9. Secure the lid with all screws and the corresponding lock washers.

Tighten the screws with 6 Nm torque in the order shown on the right hand side. The tothing of the tooth lock washers must face toward the lid.

The inverter packing list includes another spare screw and tooth lock washer.

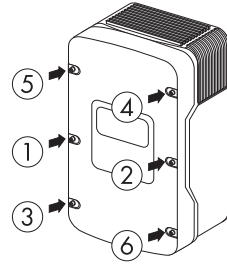

**DANGER!**

**Danger to life due to live lid.**

The grounding of the enclosure lid is ensured by the tooth lock washers.

- Fasten the tooth lock washers for all 6 screws with the tothing facing toward the lid.



**DANGER!**

**Danger to life due to high voltages in the inverter.**

- Do not switch on the line circuit breaker until the inverter is securely closed and the PV generator has been connected.

- The inverter is now connected to the public grid (AC).

### 5.2.3 Additional Grounding of the Enclosure

If a second protective conductor connection is required in the country of installation, you can also ground the inverter using a second protective conductor on the connection terminal on the enclosure.

#### Procedure

1. Insert the stripped grounding cable (D) under the clamping clip (C) (max. cross-section 16 mm<sup>2</sup>).
2. Screw the clamping clip tight with screw (A) and tooth lock washer (B).

The tothing of the tooth lock washer must face toward the clamping clip.

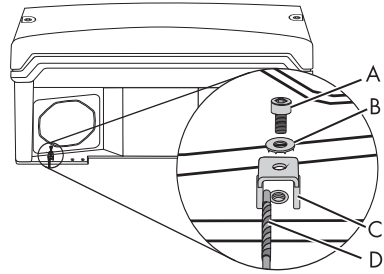

- The inverter's enclosure is additionally grounded.

You can ground multiple inverters as shown in the diagram below:

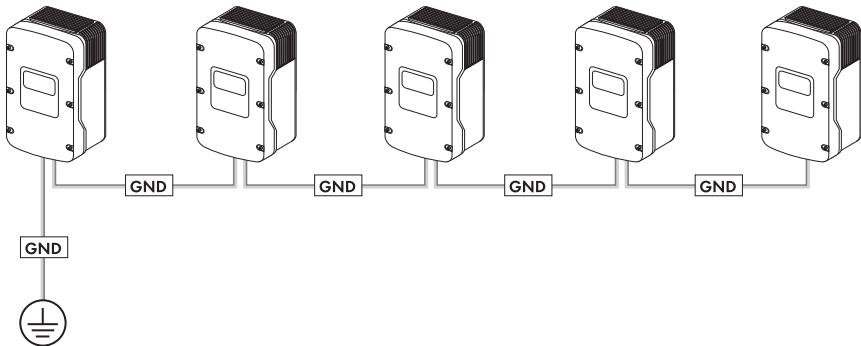

### 5.3 Setting the Display Language

You can set the language of the display using the switches on the underside of the display assembly inside the inverter.

**Procedure**

1. Open the inverter as described in section 7.2 "Opening the Inverter" (page 52).
2. Set the switches for the required language, as shown below.

Language	Switch S2	Switch S1
German	B	B
English	B	A
French	A	B
Spanish	A	A

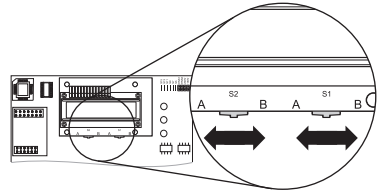

For type SMC 6000TL-IT / 7000TL-IT / 8000TL-IT inverters, the following switch settings apply:

Language	Switch S2	Switch S1
Italian	B	A
English	A	A

3. Close the inverter as described in section 7.3 "Closing the Inverter" (page 55).
- The display language is now set.

## 5.4 Connection of the PV Generator (DC)

### 5.4.1 Conditions for the DC Connection



#### Use of Adaptors

Adaptors (branch connectors) are not to be visible or freely accessible in the immediate surroundings of the inverter.

- The DC current flow may not be interrupted via adaptors.
- Observe the procedure for disconnecting the inverter as described in section 7.2 "Opening the Inverter" (page 52).
- Requirements for the PV modules of the connected strings:
  - Same type
  - Same number
  - Identical alignment
  - Identical tilt
- The connecting cables from the PV modules must be fitted with plug connectors. You will find the necessary DC plug connector for DC connection in the delivery.
- The following limiting values at the DC input of the inverter may not be exceeded:

Inverter	Maximum input voltage	Maximum input current
SMC 6000TL	700 V (DC)	19.0 A (DC)
SMC 7000TL	700 V (DC)	22.0 A (DC)
SMC 8000TL	700 V (DC)	25.0 A (DC)



#### DANGER!

**Risk of lethal electric shock or fire.**

The maximum possible input current per string is limited by the plug connectors used. If the plug connector is overloaded, an electric arc may occur and there is a fire risk.

- Ensure that the input current for each string does not exceed the maximum flow current of the plug connectors used.



#### The residual current breaker

The inverter is equipped with an integrated universal current sensitive residual-current monitoring unit. The inverter can automatically differ between real fault currents and "normal" capacitive leakage currents.

If an external RCD or residual current breaker is strictly required, you must use a switch that triggers at a failure current of 100 mA or higher.

### 5.4.2 Assembling the DC Plug Connectors

In order to connect to the inverter, all connecting cables of the PV modules must be equipped with the DC plug connectors provided.

To assemble the DC plug connectors, proceed as detailed below. Ensure the plug connectors have the correct polarity. The DC plug connectors are marked with "+" and "-" .

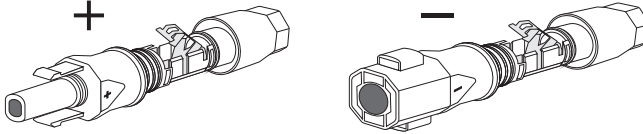

**Cable requirements:**

- Use a PV1-F cable.

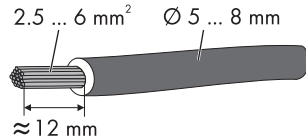

**Procedure**

1. Insert the stripped cable into the plug connector as far as it will go.
2. Press the clamping clip downward until you hear an audible click.
3. Ensure the cable is correctly in place.

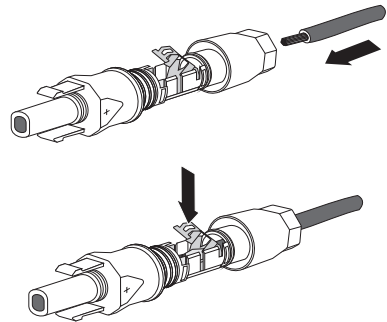

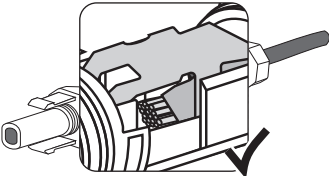
Result	Action
<p>☑ If the conductors are visible in the hollow cavity of the clamping clip, the cable is in the correct position.</p> 	<ul style="list-style-type: none"> <li>• Proceed to step 4.</li> </ul>

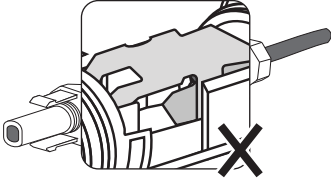
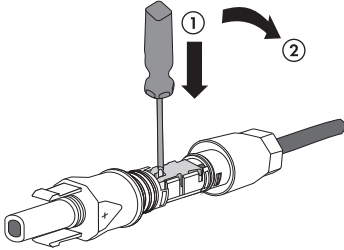
Result	Action
<p>☑ If the conductor is <b>not</b> visible in the hollow cavity of the clamp, the cable is not in the correct position.</p> 	<ul style="list-style-type: none"> <li>Loosen the clamping clip with the help of a screwdriver.</li> </ul>  <ul style="list-style-type: none"> <li>Remove cable and start again from step 1.</li> </ul>

4. Push the threaded joint to the thread and screw into place.

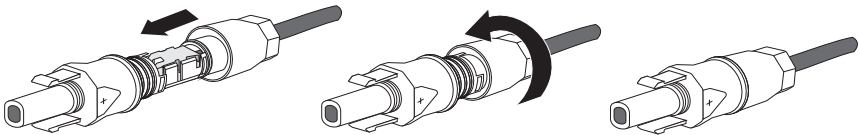

☑ The DC plug connectors are now assembled and can be connected to the inverters, as described in section 5.4.4 "Connecting the PV Generator (DC)" (page 34).



### 5.4.3 Opening the DC Plug Connectors

1. Screw the threaded joint off.
2. To release the plug connector, slot a screw driver into the side catch mechanism and lever out.
3. Carefully pull the DC plug connector apart.

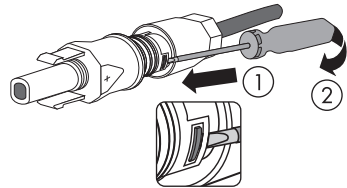
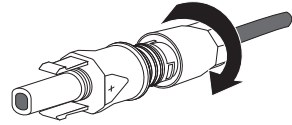

4. Loosen the clamping clip with the help of a screwdriver.
5. Remove the cable.

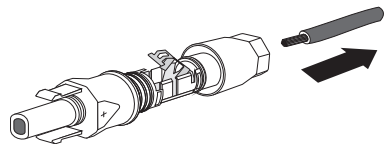
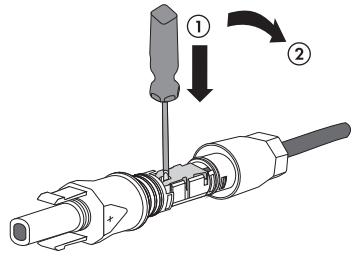
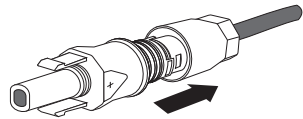

The cable is now removed from the DC plug connector.

### 5.4.4 Connecting the PV Generator (DC)

**DANGER!**  
 Danger to life due to high voltages in the inverter.

- Before connecting the PV generator, ensure that the line circuit breaker is switched off.

**NOTICE!**  
 Excessive voltages can destroy the measuring device.

- Only use measuring devices with a DC input voltage range of at least 700 V.

1. Disconnect the line circuit breaker and secure against re-connection.
2. Pull the Electronic Solar Switch downward, slightly toward the wall.

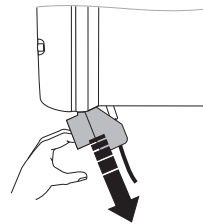

3. Check the connection cables of the PV modules for correct polarity and that the maximum input voltage of the inverter is not exceeded.

At an ambient temperature higher than 10 °C, the open circuit voltage of the PV modules must not be more than 90 % of the maximum inverter input voltage.

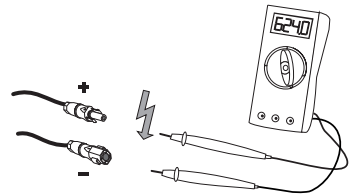

Otherwise, check the system design and the PV module connection. If this is not done, the maximum inverter input voltage can be exceeded at low temperatures.

**NOTICE!**  
 Destruction of the inverter due to overvoltage.

If the voltage of the PV modules exceeds the maximum input voltage of the inverter, it can be destroyed by the overvoltage.

All warranty claims become void.

- Do not connect strings with an open circuit voltage greater than the maximum input voltage of the inverter.
- Check the system design.

4. Check the strings for ground faults, as described in section 9.3.1 "Checking the PV Generator for a Ground Fault" (page 68).
5. Check the DC plug connector for correct polarity and connect it.  
To release the plug connectors see section 7.2 "Opening the Inverter" (page 52).

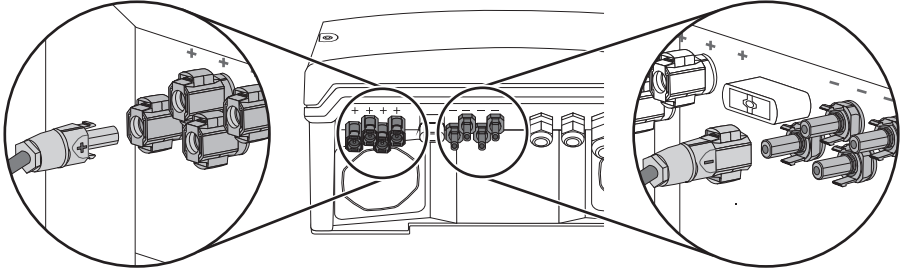

6. To create the sealing on the inverter, all the DC inputs that are not needed have to be closed as follows:

- Insert the provided sealing plugs into the unneeded DC plug connectors.  
Do **not** insert the sealing plugs into the DC inputs on the inverter.
- Insert the DC plug connectors with sealing plugs into the corresponding DC inputs on the inverter.

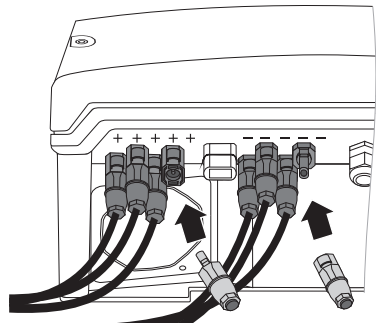
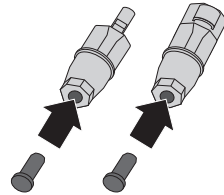

7. Check the Electronic Solar Switch for wear, as described in section 8.2 "Checking the Electronic Solar Switch (ESS) for Wear" (page 60) and attach it firmly.

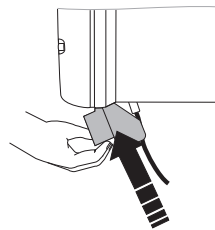

**NOTICE!****Manipulating the connector in the handle can damage the Electronic Solar Switch.**

The connector inside the handle must remain movable in order to ensure proper contact. Tightening the screw voids all warranty claims and creates a fire risk.

- Do not tighten the connector screw in the Electronic Solar Switch handle.

**NOTICE!****Damage to Electronic Solar Switch.**

If not plugged correctly, the Electronic Solar Switch can be damaged by high voltages.

- Connect the holder firmly on to the socket of the Electronic Solar Switch.
- Make sure that the device is securely in place.

- The PV generator is now connected.

You can now commission the inverter as described in section 6 "Commissioning" (page 46). The following connection possibilities are optional.

## 5.5 Connection of the SMA Power Balancer

The Sunny Mini Central is equipped with the SMA Power Balancer as standard. This enables a circuit connection of 3 Sunny Mini Central to a three-phase feed-in system.

Each of the 3 Sunny Mini Central devices in a group must be connected to a different phase conductor of the low-voltage grid (L1, L2 and L3)!

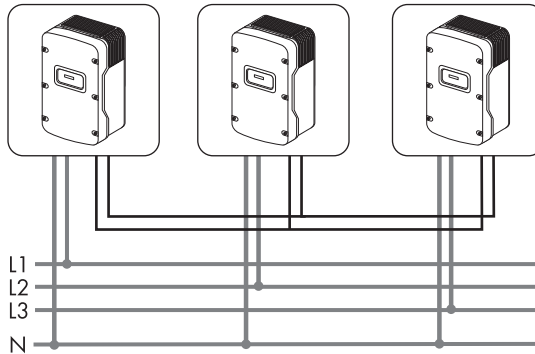

By activating this circuit, you can stipulate how the other two Sunny Mini Central devices are to react if there is a device fault with the third Sunny Mini Central or there is a grid voltage fault in its phase.



### Three-phase grid connection

For further information on this subject, see the Technical Information "Three phase connection with Sunny Mini Central" in the download area at [www.SMA.de/en](http://www.SMA.de/en).

The connections for the SMA Power Balancer are galvanically isolated from the rest of the Sunny Mini Central circuit.

### 5.5.1 Configuration

The SMA Power Balancer is deactivated at the factory using the "PowerBalancer" parameter (parameter setting = off) and can only be activated and configured using a communication device. To change the "PowerBalancer" parameter, you need a personal access code - the so-called SMA Grid Guard Code. The application form for the personal access code is located in the download area at [www.SMA.de/en](http://www.SMA.de/en), in the "Certificate" category for each inverter.

The configuration options are detailed below.

## Configuration Options

There are 4 different configuration options for the "PowerBalancer" parameter.



### Local connection requirements

Select the respective setting and always observe the local connection requirements and provisions of your utility operator.

- **FaultGuard**

This operating mode enables the implementation of three-phase grid voltage monitoring that also reacts to device failures.

- If one of the three inverters indicates a **grid voltage fault** and stops feeding in, the other two inverters also disconnect from the grid immediately.

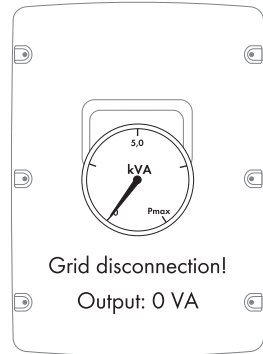
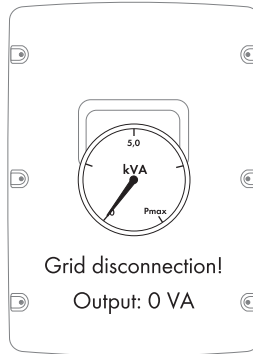
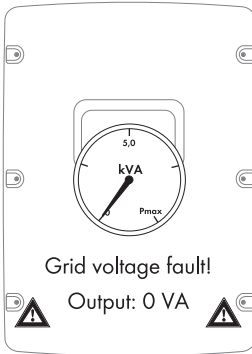

- If one of the three inverters indicates a **device fault** and stops feeding in, the other two inverters also disconnect from the grid 5 minutes later.

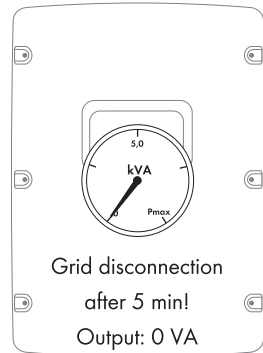
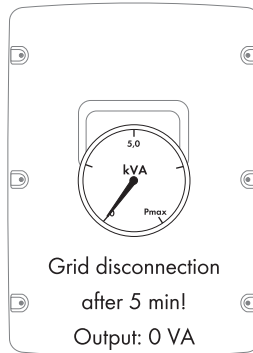
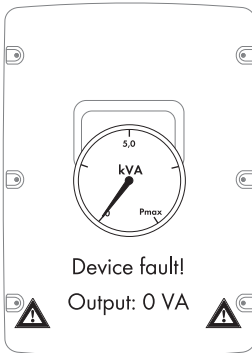

- **PhaseGuard**

This operating mode enables the implementation of three-phase grid voltage monitoring.

- If one of the three inverters indicates a **grid voltage fault** and stops feeding in, the other two inverters also disconnect from the grid automatically.

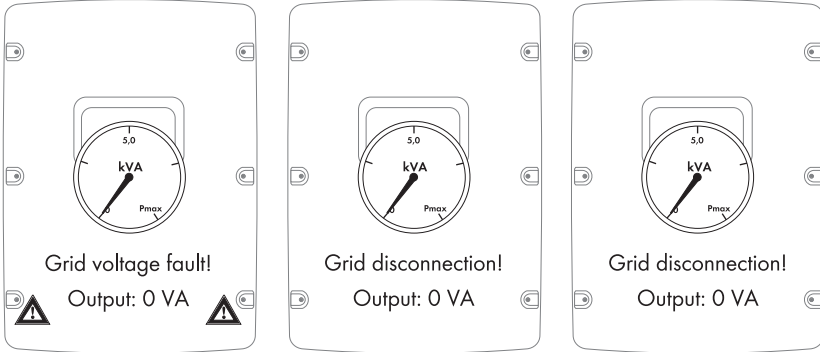

- If one of the three inverters indicates a **device fault** and stops feeding in, the other two inverters are not affected and continue to feed in at full power.

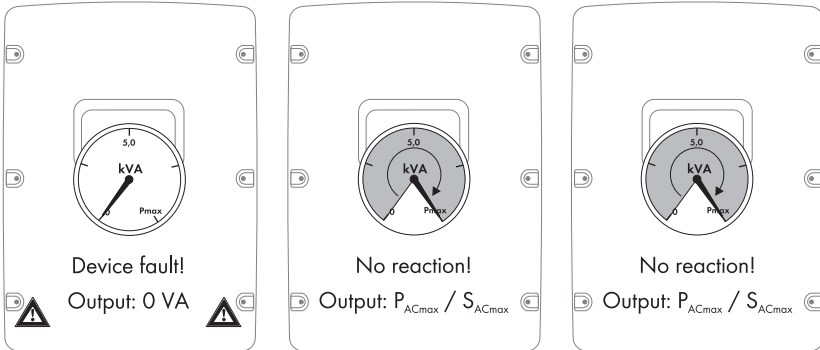

- **Off**

The SMA Power Balancer is deactivated (factory setting).

- In the event of a **device fault** or **grid voltage fault** at an inverter, only this inverter is disconnected from the grid and the other two devices continue to run at an undiminished power level.

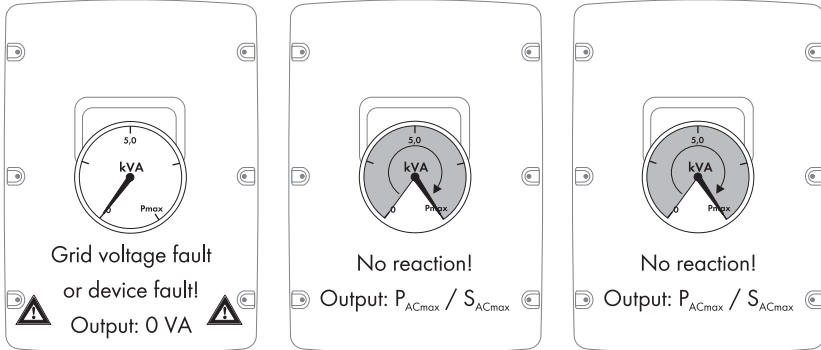

- **PowerGuard**

This setting can be selected if the entire PV plant consists of only three 3 Sunny Mini Central inverters and if, in the event of a failure, the unbalanced load should be limited to 5 kVA over a 10-minute average.



**Unbalanced load limitation for SMC 6000TL-IT / 7000TL-IT / 8000TL-IT (applies exclusively to Italy)**

For the Sunny Mini Central 6000TL-IT / 7000TL-IT / 8000TL-IT, the unbalanced load is limited to 6 kVA.

- If one of the three inverters indicates a **grid voltage fault** or **device fault** and stops feeding in, the other two inverters automatically limit their power to 5 kVA over a 10 minute average.

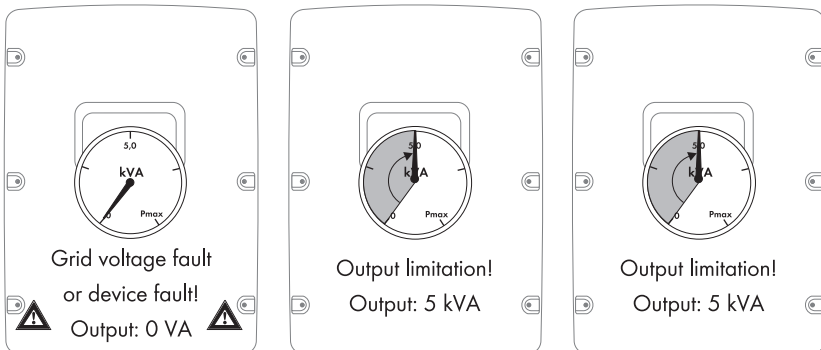



## 5.5.2 Cabling

### Cable Requirements

For cabling the SMA Power Balancer, use a "LiYCY" cable, structured as shown here:

- Indoor: LiYCY 2 x 2 x 0.25
- Outdoor: Li-2YCYv 2 x 2 x 0.25

Position	Description
A	Flexible insulation
B	Shielding
C	Twisted pair 2 (2 x 0.25 mm <sup>2</sup> )
D	Twisted pair 1 (2 x 0.25 mm <sup>2</sup> )

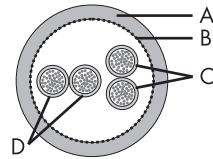

### Overview of the Connection Area

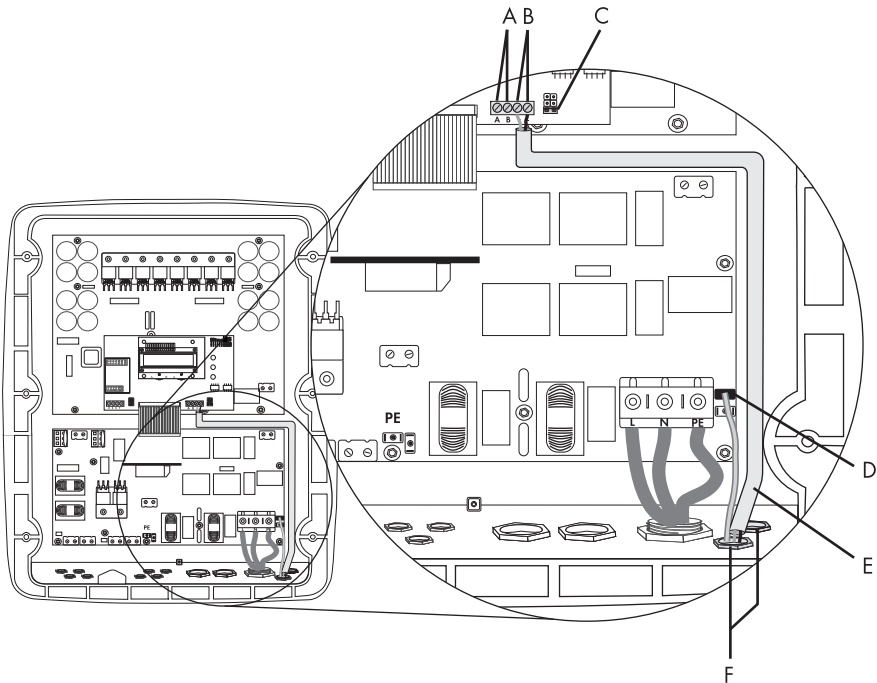

Object	Description
A	Screw terminals for the wire bridge
B	Screw terminals for connecting the wires
C	Jumper slot

Object	Description
D	PE connector
E	Silicone tube / cable route
F	Cable glands

**Procedure**

1. Open the inverter as described in section 7.2 "Opening the Inverter" (page 52).
2. Insert the cable into each inverter.  
Use one of the two cable glands (F) on the right hand side.

**! DANGER!**  
 Danger to life through high voltage if there is a fault with the SMA Power Balancer cable.

- Sheath the positive and negative cable conductors in each inverter using the enclosed silicone tube.
- Cut the silicone tube to the required length.
- The silicone tube must completely cover the cable inside the inverter enclosure.

3. Draw the cable along the cable route (E) as far as the terminal block (B).
4. Ground the cable shield in each inverter to the PE connector (D).
5. Sheath the positive and negative cable conductors in each inverter with end sleeves.
6. Connect the positive and negative pole to the corresponding screw terminals.

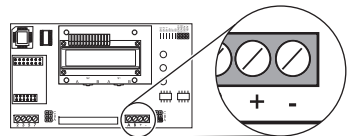

7. In order to connect the three inverters together, connect the positive and negative conductors from the two other inverters to the terminal block of the middle inverter.

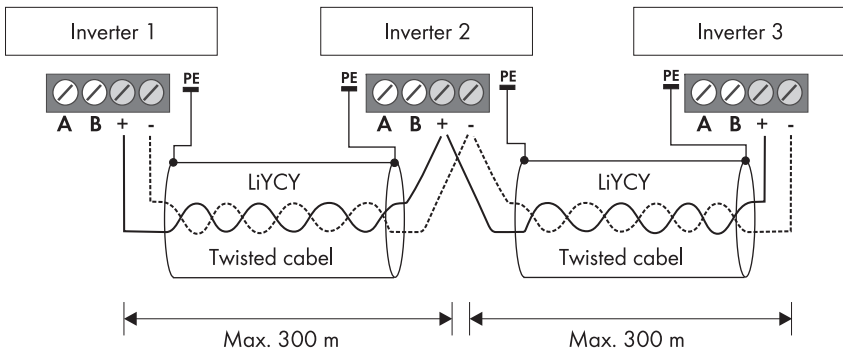

The cable length between two inverters may not exceed 300 m!

8. In the **middle** inverter **only** (with two wires for each terminal), insert one of the jumpers provided into the lowest of the three slots as shown on the right.

Do **not** plug the jumpers into the lowest slot of the two other inverters!

**or**

Bridge the "A" and "B" screw terminals on the **middle** inverter with a wire bridge.

Do **not** bridge the "A" and "B" screw terminals in the two other inverters!

9. Measure the resistance between the terminal block's positive and negative poles in the **middle** inverter.

- If the resistance is approximately 27.8 kOhms (+/370 Ohms), the SMA Power Balancer has been connected correctly. Otherwise, check the cabling.

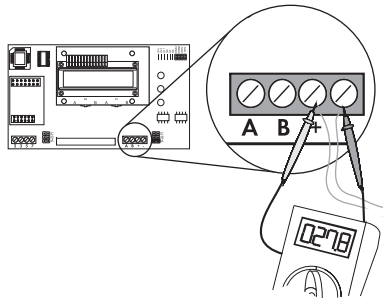
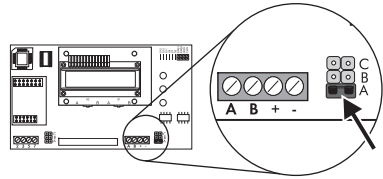

10. Close all inverters as described in section 7.3 "Closing the Inverter" (page 55).



**Connection with one Sunny Mini Central 9000TL, 10000TL or 11000TL**

In order to be able to connect the SMA Power Balancer with a Sunny Mini Central 9000TL, 10000TL or 11000TL, the Sunny Mini Central 6000TL, 7000TL oder 8000TL must be equipped with a special plug. Three inverters are then connected together with a special connection cable.

You can order the connection plug and the connection cable from SMA Solar Technology AG or your dealer. Section 12 "Accessories" (page 84) contains a list of the order numbers.

### 5.5.3 Testing the Functioning

To test whether the SMA Power Balancer operates correctly, proceed as follows.

1. Select the "PhaseGuard" setting of the "PowerBalancer" parameter for all three inverters.
2. Check whether all inverters in the group are feeding the grid normally.

- If the green LED lights up steadily or if the display message pictured opposite appears, proceed with point 3.



or

- If all inverters in this group show the adjacent display message: Check the installation of the SMA Power Balancer and contact the SMA Serviceline if necessary.

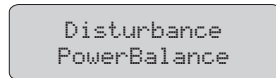

3. Switch off the line circuit breaker for one of the three inverters.
  - The inverter with a deactivated line circuit breaker then indicates a grid voltage fault with the display message shown opposite ("Bfr" and "Srr" are irrelevant).
  - The other two inverters then also disconnect themselves from the grid with the display message shown to the opposite.
  - Both inverters subsequently switch to "Balanced" mode.

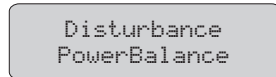
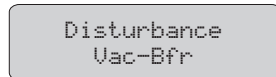

- If the inverters react as described above, the functionality test has been completed successfully. Otherwise, check the configuration.

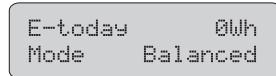

4. If applicable, reset the "PowerBalancer" parameter to the desired setting in all inverters.
5. Switch on the line circuit breaker again.
- The functionality test has been completed.

### 5.6 Communication

The inverter is equipped with a slot for communication interfaces in order to communicate with special data acquisition devices (e.g. Sunny WebBox) or a PC with corresponding software (e.g. Sunny Data Control or Sunny Explorer).

See the respective communication interface manual for a detailed circuit diagram and an installation description for the interface.

## 5.7 Setting the Grid and Country Parameters



### Changing Grid-Relevant and Country Parameters

To change grid-relevant parameters, you need a personal access code - the so-called SMA Grid Guard Code. The application form for the personal access code is located in the download area at [www.SMA.de/en](http://www.SMA.de/en), in the "Certificate" category for each inverter.

Ensure that you discuss the changes to these parameters with your utility operator.

A detailed description of the operating parameters for the inverter is available in the download area at [www.SMA.de/en](http://www.SMA.de/en) in the category "Technical Description" of the respective inverter.

### 5.7.1 Setting the Installation Country

Using the "Default" parameter you can set the installation country and/or the grid connection standard valid for the country via a communication device (e.g. Sunny WebBox) or a PC with appropriate software (e.g. Sunny Data Control or Sunny Explorer). This, however, is only required if the inverter was originally ordered for another country. You can see the standard to which the inverter was set upon delivery from the type label and the supplementary document provided with the factory settings.

### 5.7.2 Setting Stand-alone Grid Operation

To operate the inverter in a Sunny Island system, you must set the inverter via the "Default" parameter to off-grid ("OFF-Grid") operation.

You have several possibilities to set the inverter to stand-alone grid operation:

- Setting via Sunny WebBox
- or
- Setting via Sunny Data Control or Sunny Explorer.



#### **DANGER!**

**Danger to life due to high voltages in the event of outage of the public grid.**

If you set the inverter to stand-alone grid operation, it does not fulfill any country-specific standards and regulations. Therefore, if there is an outage of the public grid, there is a danger of back-feed.

- **Never** operate the inverter directly on the public grid when set to stand-alone grid operation.

## 6 Commissioning

### 6.1 Commissioning the Inverter



**Self test in accordance with DK 5640, Ed. 2.2 for initial commissioning (applies to Italy only)**

The Italian DK 5940 standard requires that an inverter can first operate on the public grid when the disconnection times for overvoltage, undervoltage, minimum frequency and maximum frequency have been checked.

Restart the self-test as described in the following section 6.2 "Self-Test in accordance with DK 5940, Ed. 2.2 (applies to Italy only)" (page 47). The test takes approx. 8 minutes.

1. Check the following requirements before commissioning:
  - The inverter is firmly fastened.
  - Correct connection of the AC cable (grid)
  - Full connection of the DC cables (PV strings)
  - DC inputs that are not needed are closed with the corresponding DC plug connectors and sealing plugs.
  - The enclosure lid is securely screwed in place
  - Electronic Solar Switch is securely plugged
  - The line circuit breaker is laid out correctly

2. Switch on the line circuit breaker.

Green LED glows: commissioning has been successful.

or

Green LED flashes when there is insufficient irradiation: network connection conditions have not yet been reached. Wait for sufficient irradiation.

or

The red or yellow LED is glowing or flashing: there has been an error. Proceed to step 3.

<b>A</b>	Green LED	Operation
<b>B</b>	Red LED	Ground fault or varistor defective
<b>C</b>	Yellow LED	Disturbance

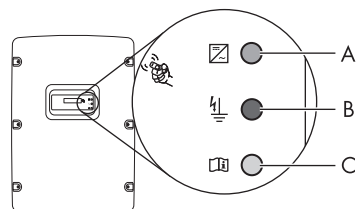

3. Read section 9 "Failure Search" (page 61) and if necessary eliminate the fault or disturbance.

## 6.2 Self-Test in accordance with DK 5940, Ed. 2.2 (applies to Italy only)

### 6.2.1 Starting the Self-Test by Tapping

You can start the self-test by tapping on the enclosure lid. Prerequisite here is that the country configuration of the inverter has been set to Italy (IT/DK5940) or "trimmed". Proceed as follows for checking the disconnection times:

1. Connect the PV generator with the inverter. The inverter can only initialize if the PV generator produces enough power. It is therefore not possible to test the disconnection times at night.
2. Connect the inverter on the AC side. For this, you have to create the AC connection (AC plug or direct connection) and/or switch on the line circuit breaker of the grid cable (fuse or automatic circuit breaker).
3. The inverter is now in the initialization phase, i.e. all 3 LEDs are glowing at the same time.  
Start the self-test **immediately** after all 3 LEDs have gone out by tapping on the display of the inverter.
4. The question on whether you would like to start the test sequence appears in the display. Tap on the display again within 30 seconds in order to confirm the question.



Avvio Autotest  
?

Once you have started the test sequence, the inverter checks the disconnection times for overvoltage, undervoltage, maximum frequency and minimum frequency one after the other. During the tests, the inverter shows the values in the display which are described in section 6.2.2 "Completion of the Self-Test" (page 47).

### 6.2.2 Completion of the Self-Test

Note the values which are displayed during the self-test. These values must be entered into a test protocol. The test results of the individual tests are displayed 3 times one after the other. The respective display appears for 10 seconds.

The self-test changes the upper and lower shut-down thresholds for each protective function on a linear basis with a modification of 0.05 Hz/s and 0.05 Vn/s for the frequency and voltage monitoring. As soon as the actual measurement value is outside the permitted range (altered shut-down threshold), the inverter disconnects itself from the grid. In this way, the inverter determines the reaction time and checks itself.

## Overvoltage Test

The inverter begins with the overvoltage test. During the test sequence, the voltage limit applied is shown in the display of the inverter.

The voltage limit is reduced successively until the shut-down threshold is achieved and the inverter disconnects from the grid.

Once the inverter has disconnected from the grid, the display successively shows the following values one after the other:

- Disconnection value,
- Calibration value,
- Reaction time,
- Present grid voltage.

```

Autotest
Uac max:      262,00V
  
```

```

Valore di soglia
con:          229,95V
  
```

```

Val. taratura
              262,00V
  
```

```

Tempo intervento
              0,08s
  
```

```

Tensione di rete
Val.eff.:    230,00V
  
```



## Undervoltage Test

After the overvoltage test, the inverter performs the undervoltage test. During the test sequence, the current calibration value of the voltage limit applied is shown in the display of the inverter.

The voltage limit is increased successively until the shut-down threshold is achieved and the inverter disconnects from the grid.

Once the inverter has disconnected from the grid, the display successively shows the following values one after the other:

- Disconnection value,
- Calibration value,
- Reaction time,
- Present grid voltage.

```

Autotest
Uac min:      188,00V
  
```

```

Valore di soglia
con:          229,95V
  
```

```

Val. taratura
              188,00V
  
```

```

Tempo intervento
              0,18s
  
```

```

Tensione di rete
Val.eff.:    230,00V
  
```

## Maximum Frequency

In the third step, the inverter tests the maximum frequency. During the test sequence, the frequency limit applied is shown in the display of the inverter.

The frequency limit is reduced successively until the shut-down threshold is achieved and the inverter disconnects from the grid.

Once the inverter has disconnected from the grid, the display successively shows the following values one after the other:

- Disconnection value,
- Calibration value,
- Reaction time,
- Present grid frequency.

```

Autotest
Fac max:      50,30Hz
  
```

```

Valore di soglia
con:          49,95Hz
  
```

```

Val. taratura
              50,29Hz
  
```

```

Tempo intervento
              0,08s
  
```

```

Frequenza rete
Val. eff.:    50,00Hz
  
```

## Minimum Frequency

In the last step, the inverter tests the minimum frequency. During the test sequence, the frequency limit applied is shown in the display of the inverter.

The frequency limit is increased successively until the shut-down threshold is achieved and the inverter disconnects from the grid.

Once the inverter has disconnected from the grid, the display successively shows the following values one after the other:

- Disconnection value,
- Calibration value,
- Reaction time,
- Present grid frequency.

```
Autotest
Fac min:      49,70Hz
```

```
Valore di soglia
con:          50,05Hz
```

```
Val. taratura
              49,71Hz
```

```
Tempo intervento
              0,08s
```

```
Frequenza rete
Val.eff.:    50,00Hz
```

When the inverter has carried out the 4 tests, it switches to "MPP operation" mode. The original calibration values are then re-set and the inverter automatically connects to the grid. If you would like to carry out the test again, you have to disconnect the inverter, in other words you have to disconnect it on the AC and DC sides and then later re-activate it. You can then restart the self-test as described in the following section 6.2.1 "Starting the Self-Test by Tapping" (page 47). The inverter begins the test sequence again, as described in section 6.2.2 "Completion of the Self-Test" (page 47).

## 7 Opening and Closing

### 7.1 Safety

**DANGER!**  
Risk of lethal electric shock.

Observe the following before opening the inverter:

- Ensure the AC side is not live.
- Ensure the DC side is not live.

**NOTICE!**  
Electrostatic discharges can damage the inverter!

Internal components of the inverter can be irreparably damaged by electrostatic discharge.

- Ground yourself before touching a component.

### 7.2 Opening the Inverter

1. Disconnect the line circuit breaker and secure against re-connection.
2. Pull the Electronic Solar Switch downward, slightly toward the wall.

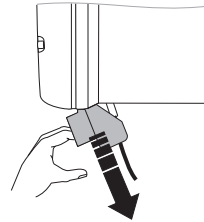

3. Using a current probe, ensure that there is no current to all DC cables.
  - If there is a current present, check the installation.

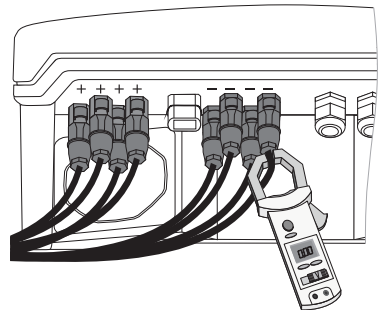

4. Release all DC plug connectors with the help of a screwdriver:
- Insert a screwdriver into one of the side slits (1).
  - Lever the screwdriver upward (2) and pull out the plug connector (3).

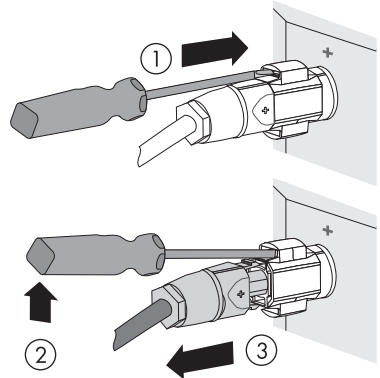

**DANGER!**

Danger to life due to high voltages in the inverter.

A secure separation from the PV generator is only guaranteed after pulling off the Electronic Solar Switch **and** all DC plug connectors.

- Remove all DC plug connectors to completely disconnect the PV generator from the inverter.

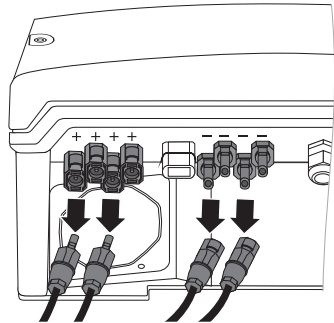

**DANGER!**

Danger to life due to high voltages in the inverter.

The capacitors in the inverter require 5 minutes to discharge.

- Wait 5 minutes before opening the inverter.

5. Ensure that there is no voltage at the DC plugs at the inverter.
  - ☑ If there is a voltage present, check the installation.

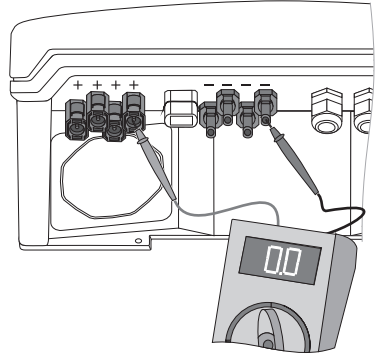

6. Loosen all 6 lid screws and pull the lid forward to remove it.

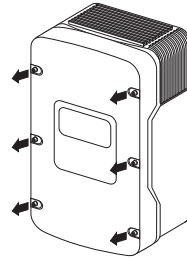

7. Verify the absence of voltage L with respect to N at the AC clamp with an appropriate meter.
  - ☑ If there is a voltage present, check the installation.

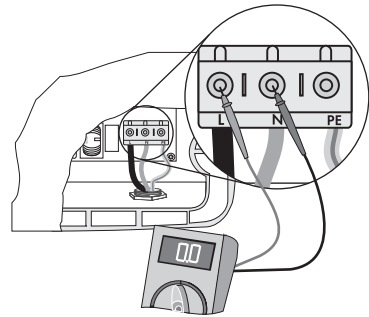

8. Verify the absence of voltage L with respect to PE at the AC clamp with an appropriate meter.
  - ☑ If there is a voltage present, check the installation.

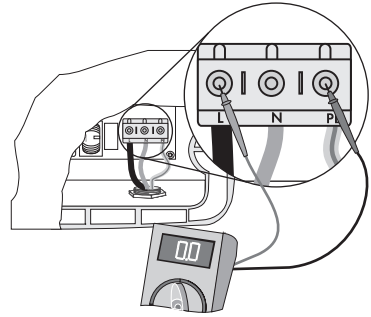

- ☑ The inverter is now open and is not live.

### 7.3 Closing the Inverter

1. Secure the lid with the 6 screws and the corresponding tooth lock washers.

Tighten the screws with 6 Nm torque in the order shown on the right hand side. The tothing of the tooth lock washers must face toward the lid.

The scope of delivery of the inverter includes another spare screw and lock washer.

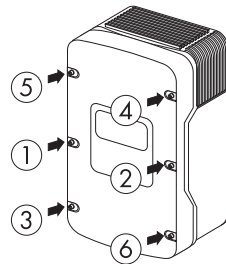

**DANGER!**  
Danger to life due to live lid.

The grounding of the enclosure lid is ensured by the tooth lock washers.

- Fasten the tooth lock washers for all 6 screws with the tothing facing toward the lid.

1. Check the DC plug connector for correct polarity and connect it.  
To release the plug connectors see section 7.2 "Opening the Inverter" (page 52).

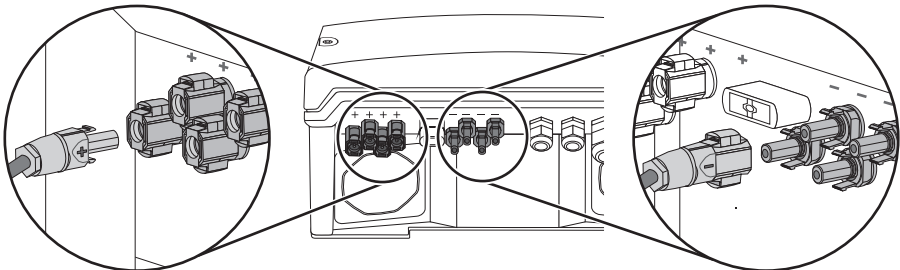

2. Close all unnecessary DC inputs as described in section 5.4.4 "Connecting the PV Generator (DC)" (page 34) to seal the inverter.
3. Check the Electronic Solar Switch for wear, as described in section 8.2 and attach it firmly.

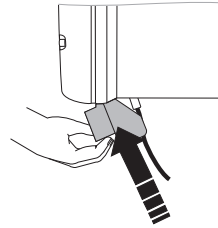

**NOTICE!**

**Manipulating the connector in the handle can damage the Electronic Solar Switch.**

The connector inside the handle must remain movable in order to ensure proper contact. Tightening the screw voids all warranty claims and creates a fire risk.

- Do **not** tighten the connector screw in the Electronic Solar Switch handle.



**NOTICE!**

**Damage to Electronic Solar Switch.**

If not plugged correctly, the Electronic Solar Switch can be damaged by high voltages.

- Connect the holder firmly on to the socket of the Electronic Solar Switch.
- Make sure that the device is securely in place.

4. Switch on the line circuit breaker.
5. Check whether the display and the LEDs indicate normal operating mode (see section 6 "Commissioning" (page 46)).

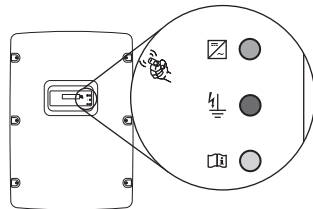

- The inverter is now closed and in operation.



## 8 Maintenance and Cleaning

### 8.1 Checking Heat Dissipation

#### 8.1.1 Cleaning the Fans

If the fan grills are only soiled with loose dust, they can be cleaned using a vacuum cleaner. If you do not achieve satisfactory results with a vacuum cleaner, dismantle the fans for cleaning.

##### Procedure

1. Disconnect the inverter from both the DC and AC connections as described in section 7.2 "Opening the Inverter" (page 52).
2. Wait for the fans to stop rotating.

##### Cleaning the Air Grills

3. Remove the air grills:
  - Press the two latches on the right edge of the fan grill to the right using a screwdriver and loosen it from the bracket.
  - Carefully remove the air grill.

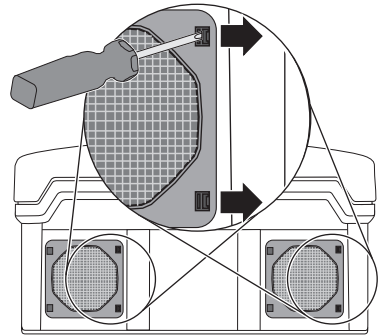

4. Clean the fan grills with a soft brush, a paint brush, a cloth or pressurized air.

##### Cleaning the fan

5. Press the front latches backward and the rear latch forward.

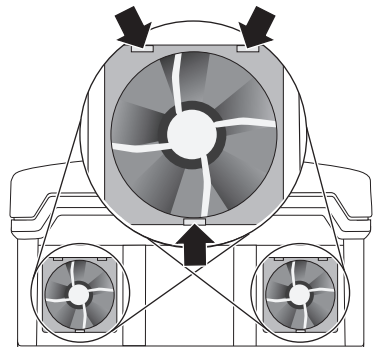

6. Remove the fan by pulling it slowly and carefully downward.
7. Unlock and remove the plug.  
The fan cables are long enough that you can lift the fans far enough out to disconnect the internal plug in the inverter.
8. Remove the fan.
9. Clean the fan with a soft brush, a paint brush, or a damp cloth.

**NOTICE!****Damage to the fan through the use of pressurized air.**

- Do not use pressurized air to clean the fan. This can damage the fan.

10. After cleaning, assemble everything in reverse order.
  - The fans are cleaned.
11. Check the function of the fans as described in the following section.

## 8.1.2 Checking the Fans

You can check that the fans are working in 2 ways:

- Set the "Fan-Test" parameter to "1" in the installer mode using Sunny Data Control, Sunny Explorer or Sunny WebBox.
- or**
- Plug the provided jumper into the system control board.

### Setting Parameters

1. Request the installer password from the SMA Serviceline (contact: see page 85).
2. Set the "Fan-Test" parameter to "1" in the installer mode.
3. Check the fans' air flow.  
The inverter sucks air in from underneath and then blows it back out on the upper sides. Listen for any unusual noise, which could indicate incorrect installation or that the fans are faulty.
4. After checking the fans, set the "Fan-Test" parameter back to 0.
  - The test of the fans has been completed.

### Plugging the Jumper

The inverter recognizes the jumper only after the system has been restarted (i.e. all LEDs must have gone out before a restart).

1. Open the inverter as described in section 7.2 "Opening the Inverter" (page 52).
2. Plug the provided jumper in the slot on the system control board as shown below.

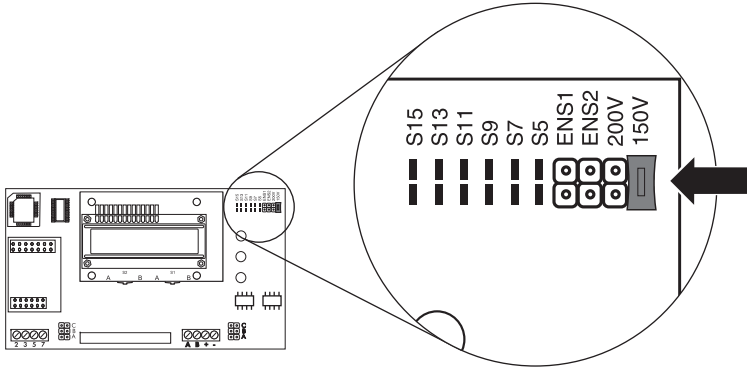

3. Close the inverter as described in section 7.3 "Closing the Inverter" (page 55).
  4. Check the fans' air flow.  
The inverter sucks air in from underneath and then blows it back out on the upper sides. Listen for any unusual noise, which could indicate incorrect installation or that the fans are faulty.
  5. After checking the fans, remove the jumper. Open and close the inverter as described in section 7 "Opening and Closing" (page 52).
- The test of the fans has been completed.

### 8.1.3 Cleaning the Air Grills

The inverter sucks air in from underneath via the fan and blows it out again through the air grills on the upper sides. Clean the air grills if they are dirty.

#### Procedure

1. Remove the air grills.  
Insert your finger above in the space between the air grills and the enclosure and remove the air grills to the side.
2. Clean the air grills with a soft brush, a paint brush, or pressurized air.
3. Re-attach the air grills to the inverter.  
The air grills must be attached according to the inside inscription ("links/left" and "rechts/right").

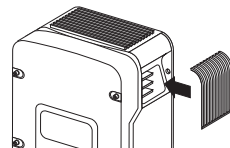
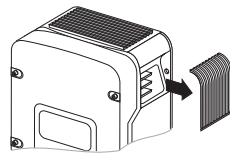

	<p><b>NOTICE!</b></p> <p><b>Risk of damage to the inverter if insects enter it!</b></p> <ul style="list-style-type: none"> <li>• The air grills must not be removed permanently, because otherwise the device is not protected against the entrance of insects!</li> </ul>
---	--

## 8.2 Checking the Electronic Solar Switch (ESS) for Wear

Check the Electronic Solar Switch for wear before plugging it in.

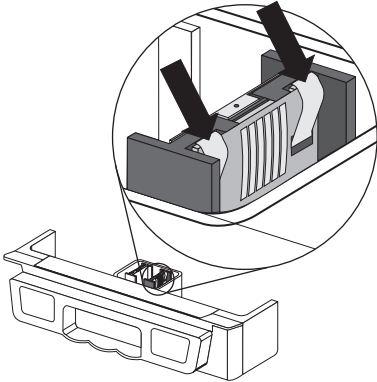
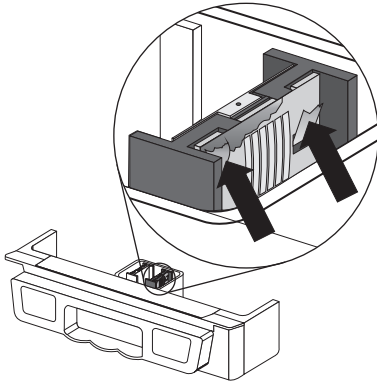
Result	Action
<p><input checked="" type="checkbox"/> The metal tongues inside the connector are not damaged or discolored.</p> 	<ol style="list-style-type: none"> <li>1. Securely attach the Electronic Solar Switch handle.</li> <li>2. Re-commission the inverter as described in section 6 "Commissioning" (page 46).</li> </ol>
<p><input checked="" type="checkbox"/> The metal tongues inside the connector have a brown discoloration or are burned through.</p> 	<p>The Electronic Solar Switch can no longer reliably disconnect the DC side.</p> <ol style="list-style-type: none"> <li>1. Replace the Electronic Solar Switch handle before attaching it again (for the order number see section 12 "Accessories" (page 84).</li> <li>2. Re-commission the inverter as described in section 6 "Commissioning" (page 46).</li> </ol>

## 9 Failure Search

If the inverter displays other blink codes or error messages other than those described in the following section, contact the SMA Serviceline

In the user manual provided, you will also find a description of the display messages during operation, the status messages and measuring channels.

Do not try to carry out repairs other than those described here. Instead, use the SMA Solar Technology AG 24-hour replacement service (the inverter will be ready for dispatch within 24 hours and sent to a forwarding agency) and repair service

### 9.1 Blink Codes

Green	Red	Yellow	Status
Glowes continuously	Is not glowing	Is not glowing	OK (feeding operation)
	Glowes continuously	Is not glowing	Ground fault or varistor defective
		Glowes continuously	OK (initialization)
Flashes quickly (3 x per second)	Is not glowing	Is not glowing	OK (stop)
	Glowes continuously	Is not glowing	Ground fault or varistor defective
Flashes slowly (1 x per second)	Is not glowing	Is not glowing	OK (waiting, grid monitoring)
Briefly goes out (approx. 1 x per second)	Glowes continuously	Is not glowing	Ground fault or varistor defective
	Is not glowing	Is not glowing	OK (derating)
Is not glowing	Is not glowing	Is not glowing	OK (disconnection)
		Glowes / flashes	Disturbance
	Glowes continuously	Is not glowing	Ground fault or varistor defective
		Glowes / flashes	Ground fault or varistor defective and disturbance

### 9.2 Error Messages

When a disturbance occurs, the inverter generates a message, which depends on the operating mode and the type of disturbance detected.

Message	Description and corrective measure
<p><b>!PV-Overvoltage!</b> <b>IDISCONNECT DC!</b></p>	<p>Overvoltage at DC input. Overvoltage can destroy the inverter.</p> <p><b>Corrective measures</b></p> <p>Disconnect the inverter from the grid immediately.</p> <ol style="list-style-type: none"> <li>1. Turn off the line circuit breaker.</li> <li>2. Remove the Electronic Solar Switch.</li> <li>3. Disconnect all the DC plug connectors.</li> <li>4. Check DC voltage:                             <ul style="list-style-type: none"> <li>- If the DC voltage exceeds the maximum input voltage, check the plant design or contact the person who installed the PV generator.</li> <li>- If the DC voltage is under the maximum input voltage, reconnect the inverter to the PV generator as described in section 5.4.4 "Connecting the PV Generator (DC)" (page 34).</li> </ul> </li> </ol> <p>If the message occurs again, disconnect the inverter again and contact the SMA Serviceline (see section 13 "Contact" (page 85)).</p>
<p><b>ACVtgRPro</b></p>	<p>The 10-minute-average grid voltage is no longer within the permissible range. This can have the following causes:</p> <p>The grid voltage at the connection point is too high.</p> <ul style="list-style-type: none"> <li>• The grid impedance at the connection point is too high.</li> </ul> <p>The inverter disconnects to assure compliance with the voltage quality of the grid.</p> <p><b>Corrective measures</b></p> <p>Check the grid voltage at the connection point of the inverter:</p> <ul style="list-style-type: none"> <li>• If, due to the local grid conditions, the grid voltage is 253 V or more, ask the utility operator whether the voltage at the feed-in point can be adjusted, or whether it would agree to an alteration of the threshold value of the ACVtgRPro parameter to monitor the voltage quality.</li> <li>• If the grid voltage is continually within the acceptable range and this error is still displayed, contact the SMA Serviceline</li> </ul>
<p><b>CAN</b></p>	<p>Internal communication fault.</p> <p><b>Corrective measures</b></p> <ul style="list-style-type: none"> <li>• If this fault occurs often, contact the SMA Serviceline</li> </ul>

Message	Description and corrective measure
<b>Derating</b>	The "Derating" operating mode is a normal operating mode which may occur occasionally and can have several causes.  If the inverter was in the "Derating" mode for at least 10 minutes, it will display the "Derating" warning until the next total shutdown of the device (at the end of the day).
	<p><b>Corrective measures</b></p> <ul style="list-style-type: none"> <li>• Check heat dissipation, as described in section 8.1 "Checking Heat Dissipation" (page 57).</li> </ul>
<b>dl-Bfr</b> <b>dl-Srr</b>	The inverter has detected a drastic change in the differential current. The integrated differential current monitoring system plays an important part in ensuring personal safety.  A drastic change in the differential current can be caused by a sudden grounding fault, failure current or an actual fault in the device. The inverter disconnects from the grid.
	<p><b>Corrective measures</b></p> <ul style="list-style-type: none"> <li>• If the message "dl-Bfr" or "dl-Srr" appears for no obvious reason, verify whether the plant insulation might have a ground fault, as described in section 9.3.1 "Checking the PV Generator for a Ground Fault" (page 68).</li> </ul>
<b>EEPROM</b>	Transition disturbance while data is being written or read from EEPROM. The data is not relevant for safe operation  The disturbance has no effect on the performance of the inverter.
<b>EEPROM dBh</b>	EEPROM data is defective, the device has switched off because the loss of data has disabled important functions of the inverter.
	<p><b>Corrective measures</b></p> <ul style="list-style-type: none"> <li>• Contact the SMA Serviceline</li> </ul>
<b>EeRestore</b>	One of the duplicate data sets in the EEPROM is defective and has been reconstructed without loss of data.  <ul style="list-style-type: none"> <li>• The error message only serves to inform you and has no effect on the performance of the inverter.</li> </ul>
<b>Fac-Bfr</b> <b>Fac-Srr</b> <b>FacFast</b>	The grid frequency is no longer within the permissible range ("Bfr" / "Srr" / "Fast" is an internal message of no relevance for the user). For safety reasons, the inverter disconnects itself from the grid.
	<p><b>Corrective measures</b></p> <ul style="list-style-type: none"> <li>• Check the grid connection and if necessary measure the grid frequency.</li> <li>• If the grid frequency is within the tolerance range, yet "Fac-Bfr", "Fac-Srr" or "FacFast" faults are still being displayed, contact the SMA Serviceline</li> </ul>

Message	Description and corrective measure
<b>Fault Curr Meas</b> <b>Fault Curr Meas-Srr</b>	Deviation in the differential current measurement / differential current
	If this fault message is displayed repeatedly, it means that inverter operation is permanently disabled. <b>Corrective measures</b> <ul style="list-style-type: none"> <li>• Contact the SMA Serviceline</li> </ul>
<b>HW-Signal</b>	Internal measurement fault or hardware defect.
	<b>Corrective measures</b> <ul style="list-style-type: none"> <li>• If this fault occurs often, contact the SMA Serviceline</li> </ul>
<b>Iac-DC_Offs-Srr</b>	A grid disturbance has occurred.
	<b>Corrective measures</b> <ul style="list-style-type: none"> <li>• Check the grid conditions.</li> <li>• Contact the SMA Serviceline if this problem occurs often or several times in succession.</li> </ul>
<b>IGBTs</b>	The internal hardware monitoring system has detected a fault in the power electronics.
	<b>Corrective measures</b> <ul style="list-style-type: none"> <li>• Contact the SMA Serviceline</li> </ul>
<b>L&lt;-&gt;N</b>	L and N are swapped on the AC connection.
	<b>Corrective measures</b> <ul style="list-style-type: none"> <li>• Check the grid connection.</li> </ul>
<b>L-Netz</b> <b>L-WR</b> <b>N-Netz</b> <b>N-WR</b>	A grid relay is faulty. The inverter checks the relays connecting it to the grid before feeding power into the grid. If the grid relays do not function properly, the inverter does not connect to the grid for safety reasons.
	<b>Corrective measures</b> <ul style="list-style-type: none"> <li>• If this fault message is displayed repeatedly, it means that inverter operation is permanently disabled.</li> <li>• If the inverter is equipped with a communication interface, try to rectify the fault using a communication product.</li> <li>• Should this be unsuccessful, contact the SMA Serviceline</li> </ul>
<b>MSD-dl</b>	Internal measurement comparison fault or hardware defect.
	<b>Corrective measures</b> <ul style="list-style-type: none"> <li>• If this fault occurs often, contact the SMA Serviceline</li> </ul>
<b>MSD-Fac</b>	Internal measurement comparison fault or hardware defect.
	<b>Corrective measures</b> <ul style="list-style-type: none"> <li>• If this fault occurs often, contact the SMA Serviceline</li> </ul>



Message	Description and corrective measure
<b>MSD-Vac</b>	Internal measurement comparison fault or hardware defect.
	<b>Corrective measures</b> <ul style="list-style-type: none"> <li>• If this fault occurs often, contact the SMA Serviceline</li> </ul>
<b>MSD-Timeout</b>	Internal measurement comparison fault or hardware defect.
	<b>Corrective measures</b> <ul style="list-style-type: none"> <li>• If this fault occurs often, contact the SMA Serviceline</li> </ul>
<b>Offset</b>	The "Offset" operating condition is a normal operating condition that occurs prior to grid monitoring. If "Offset" is displayed as an error, then there is a disturbance in the data logging.
	<b>Corrective measures</b> <ul style="list-style-type: none"> <li>• If this fault occurs often, contact the SMA Serviceline</li> </ul>
<b>PowerBalance</b>	The inverter is part of a three-phase system with two further inverters and equipped with the SMA Power Balancer for preventing unbalanced loads. The operating parameter "PowerBalancer" is set to "PhaseGuard" or "FaultGuard".
	<b>Corrective measures</b> <ul style="list-style-type: none"> <li>• For more detailed descriptions of the operation modes "PhaseGuard" and "FaultGuard", please refer to section 5.5 "Connection of the SMA Power Balancer" (page 37).</li> </ul>
<b>Relais2 Relais4</b>	A grid relay is faulty. The inverter checks the relays connecting it to the grid before feeding power into the grid. If the grid relays do not function properly, the inverter does not connect to the grid for safety reasons.
	<b>Corrective measures</b> <ul style="list-style-type: none"> <li>• If this fault message is displayed repeatedly, it means that inverter operation is permanently disabled.</li> <li>• If the inverter is equipped with a communication interface, try to rectify the fault using a communication product.</li> <li>• Should this be unsuccessful, contact the SMA Serviceline</li> </ul>
<b>Riso</b>	The electrical insulation between the PV plant and ground is faulty. The resistance between the DC plus and/or DC minus connection and ground is outside the defined limit range.
	<b>Corrective measures</b> <ul style="list-style-type: none"> <li>• Check the plant insulation.</li> <li>• Check the plant for ground faults as described in section 9.3.1 "Checking the PV Generator for a Ground Fault" (page 68).</li> </ul>

Message	Description and corrective measure
ROM	The inverter's firmware is faulty.
	<b>Corrective measures</b> <ul style="list-style-type: none"> <li>• Contact the SMA Serviceline</li> </ul>
SD-DI-Wandler	The inverter has detected an insulation fault on the DC side.
	<b>Corrective measures</b> <ul style="list-style-type: none"> <li>• Check the plant insulation.</li> <li>• Check the plant for ground faults as described in section 9.3.1 "Checking the PV Generator for a Ground Fault" (page 68).</li> </ul>
SD-Imax	The inverter has detected an overcurrent on the AC side. It disconnects from the grid for safety reasons and then attempts to reconnect to the grid.
	<b>Corrective measures</b> <ul style="list-style-type: none"> <li>• If this fault occurs often, contact the SMA Serviceline</li> </ul>
SD-WR-Bruecke	The inverter has detected a fault in the power electronics. It disconnects from the grid and then attempts to reconnect to the grid. There could also be a ground fault in the PV generator.
	<b>Corrective measures</b> <ul style="list-style-type: none"> <li>• Check for ground faults in the PV generator as described in section 9.3.1 "Checking the PV Generator for a Ground Fault" (page 68).</li> <li>• If this fault continues to occur, contact the SMA Serviceline</li> </ul>
Shutdown	Temporary inverter fault.
	<b>Corrective measures</b> <ul style="list-style-type: none"> <li>• Contact the SMA Serviceline</li> </ul>
STM Timeout	Internal program run fault.
	<b>Corrective measures</b> <ul style="list-style-type: none"> <li>• If this fault occurs often, contact the SMA Serviceline</li> </ul>

Message	Description and corrective measure
<b>Vac-Bfr</b> <b>Vac-Srr</b>	<p>The grid voltage is no longer within the permissible range ("Bfr" or "Srr" is an internal message of no relevance for the user). This code can be caused by any of the following conditions:</p> <ul style="list-style-type: none"> <li>• Grid disconnected (line circuit breaker, fuse),</li> <li>• AC cable is broken or</li> <li>• AC cable is highly resistive</li> </ul> <p>For safety reasons, the inverter disconnects itself from the grid.</p> <p><b>Corrective measures</b></p> <ul style="list-style-type: none"> <li>• Check the grid current and grid connection on the inverter.</li> <li>• If the grid voltage lies outside the acceptable range because of local grid conditions, ask the utility provider if the voltage can be adjusted at the feed-in point or if it would agree to changes in the values of the monitored operational limits (operating parameters: Vac-Min and Vac-Max).</li> <li>• If the grid frequency is within the tolerable range, yet "Vac-Bfr," or "Vac-Srr" faults are still being displayed, please contact the SMA Serviceline</li> </ul>
<b>VpvMax</b>	<p>Overvoltage at DC input. The inverter may be damaged.</p> <p><b>Corrective measures</b></p> <p>Immediately disconnect the inverter from the grid.</p> <ol style="list-style-type: none"> <li>1. Turn off the line circuit breaker.</li> <li>2. Remove the Electronic Solar Switch.</li> <li>3. Disconnect all the DC plug connectors.</li> <li>4. Check DC voltage: <ul style="list-style-type: none"> <li>- If the DC voltage exceeds the maximum input voltage, check the plant design or contact the person who installed the PV generator.</li> <li>- If the DC voltage is under the maximum input voltage, reconnect the inverter to the PV generator as described in section 5.4.4 "Connecting the PV Generator (DC)" (page 34).</li> </ul> </li> </ol> <p>If the message occurs again, disconnect the inverter again and contact the SMA Serviceline (see section 13 "Contact" (page 85)).</p>
<b>UZWK-Max</b>	<p>The internal hardware monitor has detected an overvoltage condition in the intermediate circuit of the inverter.</p> <p><b>Corrective measures</b></p> <ul style="list-style-type: none"> <li>• If this fault occurs often, contact the SMA Serviceline</li> </ul>

Message	Description and corrective measure
Watchdog Watchdog-Srr	Internal program run fault.
	<b>Corrective measures</b> <ul style="list-style-type: none"> <li>If this fault occurs often, contact the SMA Serviceline</li> </ul>

### 9.3 Red LED is Glowing Continuously

If the red LED of the status display is continuously on during operation, there is either a ground fault in the PV generator or at least one of the varistors for the overvoltage protection is defective.

#### 9.3.1 Checking the PV Generator for a Ground Fault

1. Disconnect the inverter from both the DC and AC connections as described in section 7.2 "Opening the Inverter" (page 52).



**NOTICE!**  
Excessive voltages can destroy the measuring device.

- Only use measuring devices with a DC input voltage range up to at least 700 V.

2. Measure the voltages between the plus pole of an individual string and minus pole of an individual string against the ground potential.

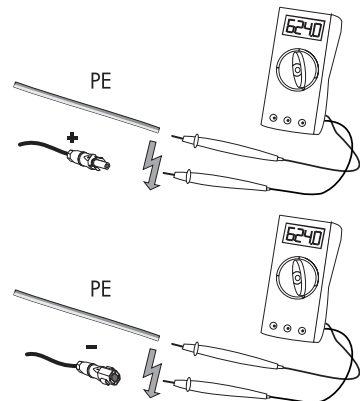

- If voltage is found, there is a ground fault in the corresponding string.



**DANGER!**  
Risk of lethal electric shock.

If a ground fault occurs, the PV generator may carry high voltages.

- Do not touch the frame of the PV generator.
- Wait until no voltage can be measured.
- Do not connect strings with ground faults to the inverter.

The approximate position of the ground fault can be determined from the ratio of the measured voltages between plus against ground potential and minus against ground potential.

Example:

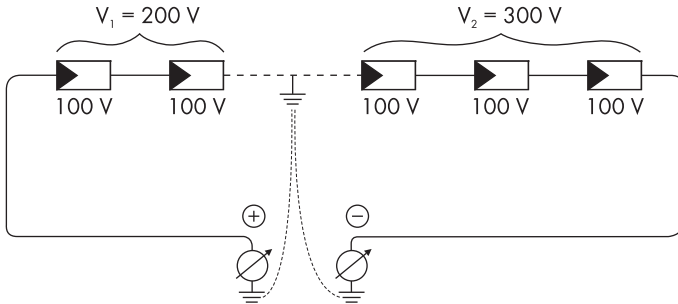

The ground fault is between the second and third module in this case.

3. Repeat step 2 for each string.

Result	Action
<input checked="" type="checkbox"/> You have found a <b>ground fault</b> .	<ul style="list-style-type: none"> <li>The installer of the PV generator must remedy the ground fault in the affected string before you may reconnect the string to the inverter.</li> <li>Do <b>not</b> reconnect the faulty string.</li> <li>Restart the inverter as described in section 7.3 "Closing the Inverter" (page 55), but <b>without</b> reconnecting the faulty string.</li> </ul>
<input checked="" type="checkbox"/> You have found <b>no ground fault</b> .	It is likely that one of the thermally monitored varistors is defective. <ul style="list-style-type: none"> <li>Check the varistors as described in section 9.3.2 "Checking the Functioning of the Varistors" (page 69).</li> </ul>

The ground fault check is finished.

### 9.3.2 Checking the Functioning of the Varistors

Varistors are wearing parts. Their functional efficiency diminishes with age or following repeated responses as a result of overvoltages. It is therefore possible that one of the thermally monitored varistors has lost its protective function.



**Position of Varistors**

You can determine the position of the varistors with the help of the illustration below.

Observe the following allocation of the terminals:

- Terminal A: outer terminal (varistor connection **with loop** [crimp])
- Terminal B: middle terminal
- Terminal C: outer terminal (varistor connection **without loop** [crimp])

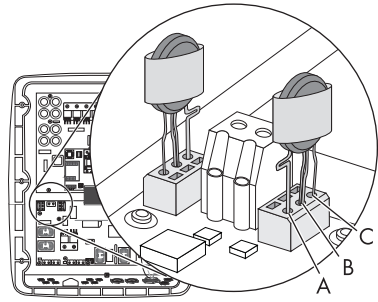

You can check the varistors as follows:

1. Open the inverter as described in section 7.2 "Opening the Inverter" (page 52).
2. Use a Multimeter to ensure that both varistors in the installed state have a conducting connection between connectors B and C.

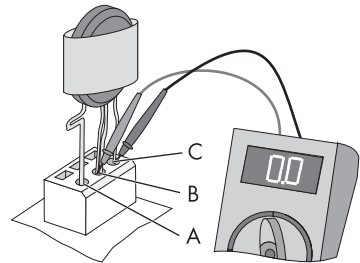

Result	Action
<input checked="" type="checkbox"/> There is a <b>conductive</b> connection.	There is probably a different fault in the inverter. <ul style="list-style-type: none"> <li>• Close the inverter as described in section 7.3 "Closing the Inverter" (page 55).</li> <li>• Contact the SMA Serviceline (see section 13 "Contact" (page 85)).</li> </ul>
<input checked="" type="checkbox"/> There is <b>no conductive</b> connection.	The respective varistor is defective and must be replaced. Varistor failure is generally due to influences which affect all varistors similarly (temperature, age, induced overvoltage). SMA Solar Technology AG recommends that you replace both varistors.  The varistors are specially manufactured for use in the inverter and are not commercially available. You must order replacement varistors directly from SMA Solar Technology AG (see section 12 "Accessories" (page 84)). <ul style="list-style-type: none"> <li>• To replace the varistors, proceed to step 3.</li> </ul>

**NOTICE!****Destruction of the inverter due to overvoltage.**

If varistors are missing, the inverter is no longer protected against overvoltages.

- Do **not** operate the inverter without varistors in plants with a high risk of overvoltages.
- Replacement varistors should be obtained as soon as possible.

3. Insert an insertion tool into the openings of the terminal contacts (1).

This releases the terminals.

If you do not receive an insertion tool for operating the terminal clamps with your replacement varistors, please contact SMA Solar Technology AG. As an alternative, the terminal contacts can be operated using a 3.5 mm wide screwdriver.

4. Remove the varistor (2).
5. Insert new varistor (3).

The pole with the small loop (crimp) must be fitted to terminal A (3) when remounting.

6. Close the inverter as described in section 7.3 "Closing the Inverter" (page 55).

The check and replacement of the varistors is completed.

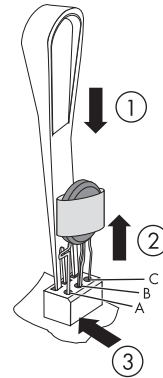

## 10 Decommissioning

### 10.1 Dismantling the Inverter

1. Open the inverter as described in section 7.2 "Opening the Inverter" (page 52).
2. Remove all cables from the inverter.
3. Close the inverter with the 6 screws and the corresponding tooth lock washers.

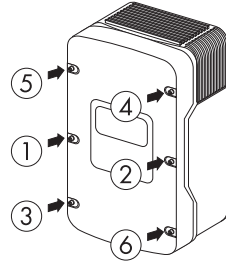

4. Remove the air grills from both sides.

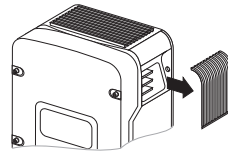

5. Remove the two screws on the left and right side of the inverter that attach it to the wall bracket.
6. Disconnect the anti-theft protection, if applicable.

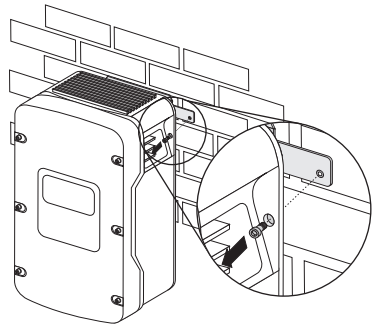

7. Remove the inverter upward from the wall mounting bracket.

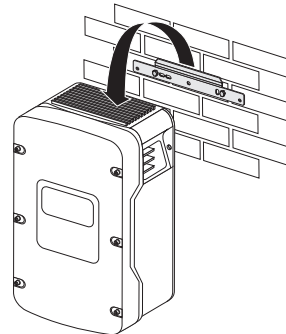



8. Use the side handles (above and below) or a steel rod (maximum diameter 30 mm) to transport the inverter. The rod must be pushed through the enclosure openings.

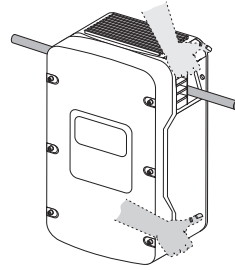

- The inverter is dismantled.

## 10.2 Packing the Inverter

If possible, always pack the inverter in its original packaging. If it is no longer available, you can also use an equivalent box. The carton must be completely closeable, have a handle system and be made to support both the weight and size of the inverter.

## 10.3 Storing the Inverter

Store the inverter in a dry place where ambient temperatures are always between  $-25\text{ °C}$  and  $+60\text{ °C}$ .

## 10.4 Disposing of the Inverter

Dispose of the inverter at the end of its service life in accordance with the disposal regulations for electronic waste which apply at the installation site at that time. Alternatively, send it back to SMA Solar Technology AG with shipping paid by sender, and labeled "ZUR ENTSORGUNG" ("for disposal") (contact see page 85).

# 11 Technical Data

## 11.1 Sunny Mini Central 6000TL

### DC Input

Maximum DC power at $\cos \varphi = 1$	$P_{DC}$	6,200 W
Maximum DC voltage *	$U_{DC \max}$	700 V
MPP voltage range	$U_{PV}$	333 V ... 500 V
DC nominal voltage	$U_{DC \text{ nom}}$	350 V
Minimum DC voltage	$U_{DC \text{ min}}$	330 V
Start voltage, adjustable	$U_{PV \text{ Start}}$	400 V
Maximum input current	$I_{PV \max}$	19.0 A
Number of MPP trackers		1
Maximum number of parallel strings		4
Voltage ripple of input voltage	$U_{pp}$	< 10 %
Internal consumption during operation		< 10 W

\* The maximum open circuit voltage, which can occur at a cell temperature of -10 °C, may not exceed the maximum input voltage.

### AC Output

AC nominal power at 230 V AC, 50 Hz	$P_{AC \text{ nom}}$	6,000 W
Maximum AC apparent power	$S_{AC \max}$	6,000 VA
Nominal AC current	$I_{AC \text{ nom}}$	27 A
Maximum output current	$I_{AC \max}$	27 A
Maximum fuse protection		50 A
Harmonic distortion of output current at AC $T_{HD}$ voltage < 2 %, AC power > 0.5 AC nominal power	$K_{IAC}$	< 3 %
Nominal AC voltage	$U_{AC \text{ nom}}$	220 V / 230 V / 240 V
AC voltage range	$U_{AC}$	180 V ... 260 V
AC grid frequency	$f_{AC \text{ nom}}$	50 Hz / 60 Hz
Operating range at AC grid frequency	$f_{AC}$	50 Hz: 45.5 Hz ... 54.5 Hz 60 Hz: 55.5 Hz ... 64.5 Hz
Power factor at nominal AC power	$\cos \varphi$	1
Supply phases		1
Connection phases		1
Overvoltage category as per AUS/NZS 60950.1:2003		II
Overvoltage category as per EN 50178:1998		III

Test voltage (DC)		2.15 kV
Test surge voltage		4 kV
Surge testing voltage with serial interface		6 kV
Internal consumption in night mode		0.25 W

### Mechanical data

Width x height x depth	468 mm x 613 mm x 242 mm
Weight	31 kg

### Climatic Conditions

Extended temperature range *	- 25 °C ... +60 °C
Extended humidity range *	0 % ... 100 %
Extended air pressure range *	79.5 kPa ... 106 kPa
Temperature range **	- 25 °C ... +70 °C
Operation temperature range	- 25 °C ... +60 °C
Maximum operating altitude above mean sea level	3,000 m

\* according to DIN EN 50178:1998-04, installation type C, class 4K4H

\*\* according to DIN EN 50178:1998-04, transport type E, class 2K3

### Features

Topology	Transformerless
Cooling concept	OptiCool
Fan connection	Designed for safe disconnection In accordance with DIN EN 50178:1998-04

### General data

Protection rating in accordance with DIN EN 60529	IP65
Protection class	I
Noise emission (typical)	≤ 31 dB(A)

### Protective equipment

All-pole DC switch-disconnector	Electronic Solar Switch, DC plug system SUNCLIX
DC overvoltage protection	Thermally monitored varistors
Personal protection ( $R_{iso} > 1 \text{ M } \Omega$ )	Insulation monitoring
Pole confusion protection	Short circuit diode
AC short circuit protection	Current control
All-pole AC disconnection unit	Automatic disconnection device SMA Grid Guard 2.1

### Communication Interfaces

Bluetooth® Wireless Technology	Optional
RS485, galvanically isolated	Optional

### Electronic Solar Switch

Electrical service life in the event of a short circuit, with a nominal current of 35 A	A minimum of 50 switching operations
Maximum switching current	35 A
Maximum switching voltage	800 V
Maximum PV power	12 kW
Protection rating when plugged	IP65
Protection rating when unplugged	IP21

### Efficiency

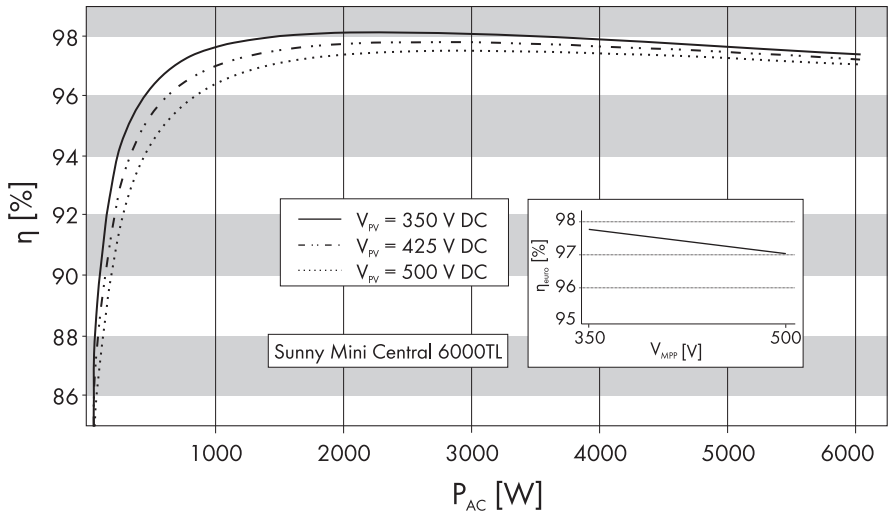

Peak efficiency	$\eta_{max}$	98 %
European efficiency	$\eta_{euro}$	97.7 %

## 11.2 Sunny Mini Central 7000TL

### DC Input

Maximum DC power at $\cos \varphi = 1$	$P_{DC}$	7,200 W
Maximum DC voltage *	$U_{DC \max}$	700 V
MPP voltage range	$U_{PV}$	333 V ... 500 V
DC nominal voltage	$U_{DC \text{ nom}}$	350 V
Minimum DC voltage	$U_{DC \min}$	330 V
Start voltage, adjustable	$U_{PV \text{ Start}}$	400 V
Maximum input current	$I_{PV \max}$	22 A
Number of MPP trackers		1
Maximum number of parallel strings		4
Voltage ripple of input voltage	$U_{pp}$	< 10 %
Internal consumption during operation		< 10 W

\* The maximum open circuit voltage, which can occur at a cell temperature of -10 °C, may not exceed the maximum input voltage.

### AC Output

AC nominal power at 230 V AC, 50 Hz	$P_{AC \text{ nom}}$	7,000 W
Maximum AC apparent power	$S_{AC \max}$	7,000 VA
Nominal AC current	$I_{AC \text{ nom}}$	31 A
Maximum output current	$I_{AC \max}$	31 A
Maximum fuse protection		50 A
Harmonic distortion of output current at AC $T_{HD}$ voltage < 2 %, AC power > 0.5 AC nominal power	$K_{IAC}$	< 3 %
Nominal AC voltage	$U_{AC \text{ nom}}$	220 V / 230 V / 240 V
AC voltage range	$U_{AC}$	180 V ... 260 V
AC grid frequency	$f_{AC \text{ nom}}$	50 Hz / 60 Hz
Operating range at AC grid frequency	$f_{AC}$	50 Hz: 45.5 Hz ... 54.5 Hz 60 Hz: 55.5 Hz ... 64.5 Hz
Power factor at nominal AC power	$\cos \varphi$	1
Supply phases		1
Connection phases		1
Overvoltage category as per AUS/NZS 60950.1:2003		II
Overvoltage category as per EN 50178:1998		III
Test voltage (DC)		2.15 kV
Test surge voltage		4 kV

Surge testing voltage with serial interface		6 kV
Internal consumption in night mode		0.25 W

### Mechanical data

Width x height x depth	468 mm x 613 mm x 242 mm
Weight	32 kg

### Climatic Conditions

Extended temperature range *	- 25 °C ... +60 °C
Extended humidity range *	0 % ... 100 %
Extended air pressure range *	79.5 kPa ... 106 kPa
Temperature range **	- 25 °C ... +70 °C
Operation temperature range	- 25 °C ... +60 °C
Maximum operating altitude above mean sea level	3,000 m

\* according to DIN EN 50178:1998-04, installation type C, class 4K4H

\*\* according to DIN EN 50178:1998-04, transport type E, class 2K3

### Features

Topology	Transformerless
Cooling concept	OptiCool
Fan connection	Designed for safe disconnection In accordance with DIN EN 50178:1998-04

### General data

Protection rating in accordance with DIN EN 60529	IP65
Protection class	I
Noise emission (typical)	≤ 33 dB(A)

### Protective equipment

All-pole DC switch-disconnector	Electronic Solar Switch, DC plug system SUNCLIX
DC overvoltage protection	Thermally monitored varistors
Personal protection ( $R_{iso} > 1 \text{ M } \Omega$ )	Insulation monitoring
Pole confusion protection	Short circuit diode
AC short circuit protection	Current control
All-pole AC disconnection unit	Automatic disconnection device SMA Grid Guard 2.1

### Communication Interfaces

Bluetooth	Optional
RS485, galvanically isolated	Optional

### Electronic Solar Switch

Electrical service life in the event of a short circuit, with a nominal current of 35 A	A minimum of 50 switching operations
Maximum switching current	35 A
Maximum switching voltage	800 V
Maximum PV power	12 kW
Protection rating when plugged	IP65
Protection rating when unplugged	IP21

### Efficiency

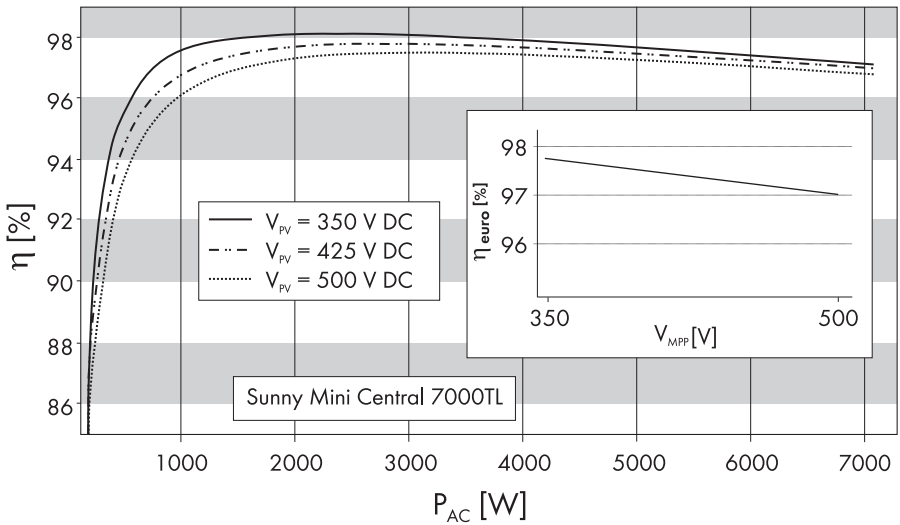

Peak efficiency	$\eta_{max}$	98 %
European efficiency	$\eta_{euro}$	97.7 %



## 11.3 Sunny Mini Central 8000TL

### DC Input

Maximum DC power at $\cos \varphi = 1$	$P_{DC}$	8,250 W
Maximum DC voltage *	$U_{DC \max}$	700 V
MPP voltage range	$U_{PV}$	333 V ... 500 V
DC nominal voltage	$U_{DC \text{ nom}}$	350 V
Minimum DC voltage	$U_{DC \min}$	330 V
Start voltage, adjustable	$U_{PV \text{ Start}}$	400 V
Maximum input current	$I_{PV \max}$	25 A
Number of MPP trackers		1
Maximum number of parallel strings		4
Voltage ripple of input voltage	$U_{pp}$	< 10 %
Internal consumption during operation		< 10 W

\* The maximum open circuit voltage, which can occur at a cell temperature of -10 °C, may not exceed the maximum input voltage.

### AC Output

AC nominal power at 230 V AC, 50 Hz	$P_{AC \text{ nom}}$	8,000 W
Maximum AC apparent power	$S_{AC \max}$	8,000 VA
Nominal AC current	$I_{AC \text{ nom}}$	35 A
Maximum output current	$I_{AC \max}$	35 A
Maximum fuse protection		50 A
Harmonic distortion of output current at AC $T_{HD}$ voltage < 2 %, AC power > 0.5 AC nominal power	$K_{IAC}$	< 3 %
Nominal AC voltage	$U_{AC \text{ nom}}$	220 V / 230 V / 240 V
AC voltage range	$U_{AC}$	180 V ... 260 V
AC grid frequency	$f_{AC \text{ nom}}$	50 Hz / 60 Hz
Operating range at AC grid frequency	$f_{AC}$	50 Hz: 45.5 Hz ... 54.5 Hz 60 Hz: 55.5 Hz ... 64.5 Hz
Power factor at nominal AC power	$\cos \varphi$	1
Supply phases		1
Connection phases		1
Overvoltage category as per AUS/NZS 60950.1:2003		II
Overvoltage category as per EN 50178:1998		III
Test voltage (DC)		2.15 kV
Surge testing voltage		4 kV

Surge testing voltage with serial interface		6 kV
Internal consumption in night mode		0.25 W

### Mechanical data

Width x height x depth		468 mm x 613 mm x 242 mm
Weight		33 kg

### Climatic Conditions

Extended temperature range *		- 25 °C ... +60 °C
Extended humidity range *		0 % ... 100 %
Extended air pressure range *		79.5 kPa ... 106 kPa
Temperature range **		- 25 °C ... +70 °C
Operation temperature range		- 25 °C ... +60 °C
Maximum operating altitude above mean sea level		3,000 m

\* according to DIN EN 50178:1998-04, installation type C, class 4K4H

\*\* according to DIN EN 50178:1998-04, transport type E, class 2K3

### Features

Topology		Transformerless
Cooling concept		OptiCool
Fan connection		Designed for safe disconnection In accordance with DIN EN 50178:1998-04

### General data

Protection rating in accordance with DIN EN 60529		IP65
Protection class		I
Noise emission (typical)		≤ 40 dB(A)

### Protective equipment

All-pole DC switch-disconnector		Electronic Solar Switch, DC plug system SUNCLIX
DC overvoltage protection		Thermally monitored varistors
Personal protection ( $R_{iso} > 1 \text{ M } \Omega$ )		Insulation monitoring
Pole confusion protection		Short circuit diode
AC short circuit protection		Current control
All-pole AC disconnection unit		Automatic disconnection device SMA Grid Guard 2.1

### Communication Interfaces

Bluetooth	Optional
RS485, galvanically isolated	Optional

### Electronic Solar Switch

Electrical service life in the event of a short circuit, with a nominal current of 35 A	A minimum of 50 switching operations
Maximum switching current	35 A
Maximum switching voltage	800 V
Maximum PV power	12 kW
Protection rating when plugged	IP65
Protection rating when unplugged	IP21

### Efficiency

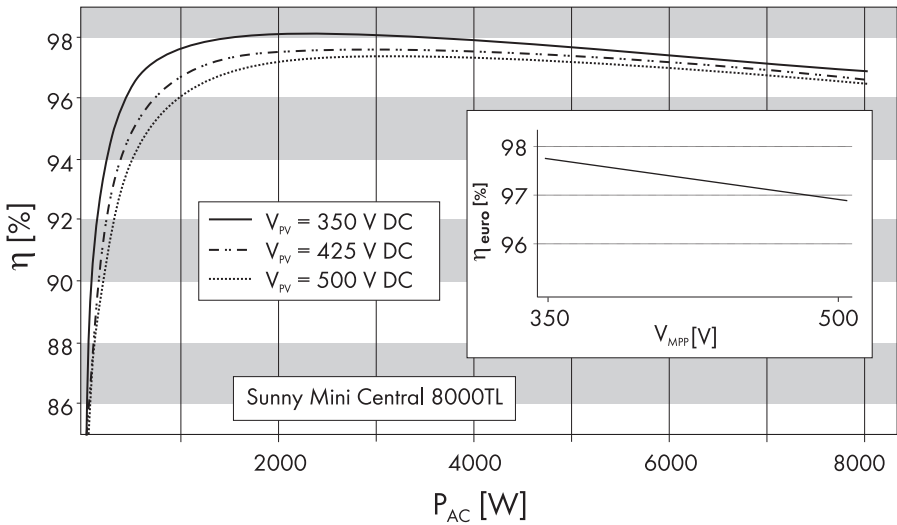

Peak efficiency	$\eta_{max}$	98 %
European efficiency	$\eta_{euro}$	97.7 %

## 12 Accessories

You will find the corresponding accessories and replacement parts for your product in the following overview. If required, you can order these from SMA Solar Technology AG or your dealer.

<b>Description</b>	<b>Brief description</b>	<b>SMA order number</b>
SMA Power Balancer plug	Upgrade kit to retrofit a Sunny Mini Central Equipped with an SMA Power Balancer to SMA Power Balancer Connector System	PBL-SMC-10-NR
SMA Power Balancer Y cable	Connecting cable (2 x 2 m) for SMA Power Balancer connector system	PBL-YCABLE-10
Electronic Solar Switch	ESS handle replacement part	ESS-HANDLE:04
Air grills	Air grill set "right and left" as spare part	45-7202
Replacement varistors	Set of thermally monitored varistors (2 pcs.) including insertion tool	MSWR-TV 7
Insertion tool for replacing the varistors	Installation tool for varistors	SB-TVWZ
RS485 upgrade kit	RS485 interface	485PB-SMC-NR
Bluetooth upgrade kit	Bluetooth communication interface	BTPBINV-NR
SUNCLIX DC plug connectors	Field connectors for conductor cross sections 2.5 mm <sup>2</sup> ... 6 mm <sup>2</sup>	SUNCLIX-FC6-SET

## 13 Contact

If you have technical problems concerning our products, contact the SMA Serviceline. We require the following information in order to provide you with the necessary assistance:

- Inverter type
- Inverter serial number
- Type and number of PV modules connected
- Optional equipment, e.g. communication devices
- Blink code or display of inverter

### **SMA Solar Technology AG**

Sonnenallee 1

34266 Niestetal, Germany

[www.SMA.de](http://www.SMA.de)

### **SMA Serviceline**

Inverters: +49 561 9522 1499

Communication: +49 561 9522 2499

Fax: +49 561 9522 4699

E-Mail: [Serviceline@SMA.de](mailto:Serviceline@SMA.de)



The information contained in this document is the property of SMA Solar Technology AG. Publishing its content, either partially or in full, requires the written permission of SMA Solar Technology AG. Any internal company copying of the document for the purposes of evaluating the product or its correct implementation is allowed and does not require permission.

## Exclusion of liability

The general terms and conditions of delivery of SMA Solar Technology AG shall apply.

The content of these documents is continually checked and amended, where necessary. However, discrepancies cannot be excluded. No guarantee is made for the completeness of these documents. The latest version is available online at [www.SMA.de](http://www.SMA.de) or from the usual sales channels.

Guarantee or liability claims for damages of any kind are excluded if they are caused by one or more of the following:

- Damages during transportation
- Improper or inappropriate use of the product
- Operating the product in an unintended environment
- Operating the product whilst ignoring relevant, statutory safety regulations in the deployment location
- Ignoring safety warnings and instructions contained in all documents relevant to the product
- Operating the product under incorrect safety or protection conditions
- Altering the product or supplied software without authority
- The product malfunctions due to operating attached or neighboring devices beyond statutory limit values
- In case of unforeseen calamity or force majeure

The use of supplied software produced by SMA Solar Technology AG is subject to the following conditions:

- SMA Solar Technology AG rejects any liability for direct or indirect damages arising from the use of software developed by SMA Solar Technology AG. This also applies to the provision or non-provision of support activities.
- Supplied software not developed by SMA Solar Technology AG is subject to the respective licensing and liability agreements of the manufacturer.

## SMA Factory Warranty

The current guarantee conditions come enclosed with your device. These are also available online at [www.SMA.de](http://www.SMA.de) and can be downloaded or are available on paper from the usual sales channels if required.

## Trademarks

All trademarks are recognized even if these are not marked separately. Missing designations do not mean that a product or brand is not a registered trademark.

The *Bluetooth*<sup>®</sup> word mark and logos are registered trademarks owned by Bluetooth SIG, Inc. and any use of such marks by SMA Solar Technology AG is under license.

### SMA Solar Technology AG

Sonnenallee 1

34266 Niestetal

Germany

Tel. +49 561 9522-0

Fax +49 561 9522-100

[www.SMA.de](http://www.SMA.de)

E-Mail: [info@SMA.de](mailto:info@SMA.de)

© 2004 to 2010 SMA Solar Technology AG. All rights reserved

SMA Solar Technology AG

[www.SMA.de](http://www.SMA.de)

